

SADRŽAJ - CONTENTS - INHALTSVERZEICHNIS



**SPIRALNE BURGIJE
TWIST DRILLS
SPIRALBORER**



**NAVOJNI ALAT
THREADING TOOLS
GEWINDESCHNEIDWERKZEUGE**



**SPECIJALNI ALAT
SPECIAL TOOLS
SPECIALWERKZEUGE**



**ALAT SA TVRDIM METALOM
CARBIDE TIPPED TOOLS
HARTMETALLWERKZEUGE**



















**KOMPLETI REZNOG ALATA
SETS OF THE CUTTING TOOL
SCHNEIDWERKZEUGESÄTZE**

OPIS SKRAĆENICA - DESCRIPTION - MERK

HSS	BRZOREZNI ČELIK Z GRUPE LEGIRANJA S 6-5-2	HIGH SPEED STEEL	SCHNELLARBEITSSTAHL
Co 5%	BRZOREZNI ČELIK IZ GRUPE LEGIRANJA S 6-5-2-5 - KOBALT 5 %	HIGH SPEED STEEL COBALT 5 %	SCHNELLARBEITSSTAHL MIT KOBALT 5 %
Co 8%	BRZOREZNI ČELIK IZ GRUPE LEGIRANJA S 2-10-1-8 - KOBALT 8 %	HIGH SPEED STEEL COBALT 8 %	SCHNELLARBEITSSTAHL MIT KOBALT 8 %
HM	TVRDI METAL	HARD METAL	HARTMETALL
R	DESNOREZNO	RIGHT	RECHTSSCHNEIDEND
L	LJEVOREZNO	LEFT	LINKSSCHNEIDEND
W	ZA RAD U MEKIM (M) MATERIJALIMA	WORK IN SOFT MATERIALS	BEARBEITUNG DER WEICHEN MATERIALE
N	ZA RAD U NORMALNIM (N) MATERIJALIMA	WORK IN NORMAL MATERIALS	BEARBEITUNG DER NORMALEN MATERIALE
H	ZA RAD U TVRDIM (T) MATERIJALIMA	WORK IN HARD MATERIALS	BEARBEITUNG DER HARTEN MATERIALE
ROLLED	VALJANE (TEHNOLOGIJA IZRADE)	ROLLED (EXECUTION)	GEROLLT (AUSFUHRUNG)
MILLED	GLODANE (TEHNOLOGIJA IZRADE)	GLODANE (EXECUTION)	GEFRÄST (AUSFUHRUNG)
GROUND	BRUŠENE (TEHNOLOGIJA IZRADE)	MILLED (EXECUTION)	GESCHLIFFEN (AUSFUHRUNG)
BRIGHT	SVIJETLO	BRIGHT (FINISH)	BLANK
BLACK	CRNO	BLACK (FINISH)	SCHWARZ
GOLD	ZLATNO	GOLD (FINISH)	GOLD
A	NORMALAN OBLIK VRHA SA ODBRUŠENIM JEZGROM	A - POINT ANGLE	A - FORM AUSGESPITZTE QUERSCHNEIDE
C	OBLIK VRHA SA KRSTASTO ODBRUŠENIM JEZGROM	C - POINT ANGLE	C - SPITZENFORM MIT KREUZANSCHLIFF
MT N°	VELIČINA KUPE	MORSETAPER	MORSEKONUS N°
BRAD	POSEBAN OBLIK VRHA	BRAD - POINT ANGLE	FORM ZENTRUMSPITZE
A	60° - ZABUŠIVAČI - OBLIK "A"	60° - CENTER DRILLS - TYPE "A"	60° - ZENTRIERBOHRER - FORM "A"
R	60° - ZABUŠIVAČI - OBLIK "R"	60° - CENTER DRILLS - TYPE "R"	60° - ZENTRIERBOHRER - FORM "R"
B	60°/120° - ZABUŠIVAČI - OBLIK "B"	60°/120° CENTER DRILLS - TYPE "B"	60°/120° - ZENTRIERBOHRER - FORM "B"
FLAT	FLEKA - ZARAVAN	TYPE - FLAT	FLÄCHE
INTERRUPTED	OBLIK - VADENI ZUB	TYPE - INTERRUPTED	FORM - AUSGESETZEN
ROLLING THREAD	OBLIK - UVALJIVAČ NAVOJA	TYPE - ROLLING THREAD	FORM - GEWINDEFORMER
SPIRAL ENTRY	OBLIK - KOŠA REZNA IVICA	TYPE - SPIRAL ENTRY	FORM - SCHELLANSCHNITT
STRAIGHT	OBLIK DRŠKE - VALJKASTA	TYPE - STRAIGHT SHANK	FORM - ZYLINDERSCHAFT
WELDON	OBLIK DRŠKE - SA FLEKOM	TYPE - WELDON SHANK	FORM - WELDON SCHAFT
SCREWED	OBLIK DRŠKE - SA NAVOJEM	TYPE - SCREWED SHANK	FORM - GEWINDE SCHAFT

SADRŽAJ - CONTENTS - INHALTSVERZEICHNIS

<p>SPIRALNE BURGIJE VALJKASTE TWIST DRILLS STRAIGHT SHANK SPIRALBORER MIT ZYLINDERSCHAFT</p>		<p>2B - 34B</p>
<p>SPIRALNE BURGIJE KUPASTE TWIST DRILLS MORSE TAPER SHANK SPIRALBORER MIT MORSEKEGELSCHAFT</p>		<p>21B - 35B</p>
<p>ZABUŠIVAČI COUNTERSINKS ZENTRIERBOHRER</p>		<p>36B</p>
<p>RUČNI UREZNICI HAND TAPS HANDGEWINDEBOHRER</p>		<p>3N - 10N</p>
<p>MAŠINSKI UREZNICI MACHINE TAPS MACHINENGEWINDEBOHRER</p>		<p>11N - 22N</p>
<p>MAŠINSKI UREZNICI, CIJEVNI NAVOJ 1:16 MACHINE TAPS, PIPE THREAD (1:16) MACHINENGEWINDEBOHRER ROHRGEWINDE (1:16)</p>		<p>23N</p>
<p>NAREZNICE OKRUGLE ROUND DIES RUNDE SCNEIDEISEN</p>		<p>24N - 28N</p>
<p>GLODALA END MILLS FRASER</p>		<p>3S - 24S</p>
<p>RAZVRTAČI REAMERS REIBAHLEN</p>		<p>27S - 34S</p>
<p>UPUŠTAČI COUNTERBORERS SENKER</p>		<p>35S - 49S</p>
<p>REDUCIR ČAURE TAPER SLEEVES VERLANGERUNGSHULSEN</p>		<p>50S - 51S</p>
<p>NOŽEVI TOOL BITS DREHLINGE</p>		<p>52S - 53S</p>
<p>STRUGARSKI NOŽEVI SA TM CT - TOOL BITS HM - DREHLINGE</p>		<p>2T - 4T</p>
<p>SPIRALNE BURGIJE SA TM CARBIDE TIPPED TWIST DRILLS HARTMETALL SPIRALBOHRER</p>		<p>5T - 11T</p>
<p>GLODALA SA TM CT - END MILLS HM - FRASER</p>		<p>12T - 13T</p>
<p>RAZVRTAČI SA TM CT - REAMERS HM - REIBAHLEN</p>		<p>14T - 18T</p>
<p>KOMPLETI REZNOG ALATA SETS OF THE CUTTING TOOL SCHNEIDWERKZEUGESATZE</p>		<p>1K - 6K</p>

EXTRA KRATKE SPIRALNE BURGJE

EXTRA SHORT TWIST DRILLS

KAROSSERIEBOHRER ANBOHRER

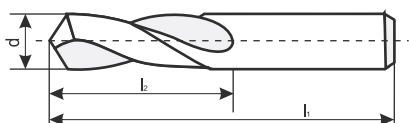

Series				BV54	BV55	BV56
	Material			HSS	HSS	Co 5%
	Type			RN	RN	RN
	Point angle			118°	118°	130°/C
	Execution			ground	ground	ground
	Finish			black	bright	gold
	d	l ₁	l ₂	price EUR		
	mm	mm	mm	each	each	each
00200	2.00	35	12	0,564	0,564	0,960
00250	2.50	37	14	0,600	0,600	1,032
00300	3.00	40	16	0,648	0,648	1,104
00310	3.10	40	16	0,672	0,672	1,140
00320	3.20	40	16	0,696	0,696	1,176
00325	3.25	40	16	0,696	0,696	1,176
00330	3.30	40	16	0,708	0,708	1,212
00350	3.50	42	16	0,780	0,780	1,320
00380	3.80	44	18	0,888	0,888	1,500
00400	4.00	44	18	0,888	0,888	1,500
00410	4.10	44	18	0,888	0,888	1,500
00420	4.20	44	18	0,888	0,888	1,500
00450	4.50	48	20	0,972	0,972	1,656
00480	4.80	48	20	1,080	1,080	1,836
00500	5.00	50	22	1,140	1,140	1,944
00550	5.50	52	24	1,380	1,380	2,352
00600	6.00	55	26	1,488	1,488	2,532

*Posebno označene stavke (**bold**) odnose se na robu koju imamo na lageru. Za ostali asortiman rabate i rokove isporuke dajemo na osnovu upita.

*Items given in **bold** figures refer to products on stock. Discount and delivery terms for other product assortment are given at request.

*Die separat gekennzeichneten artikel (**bold**) beziehen sich auf die Ware, die auf Lager liegt. Die Rabatte und Lieferzeiten für das restliche Sortiment geben wir auf Anfrage bekannt.

DVOSTRANE SPIRALNE BURGIJE

STUB DOUBLE END DRILLS

KAROSSERIEBOHRER DOPPELSEITIGE

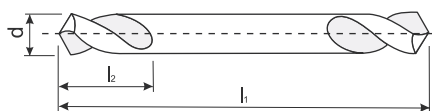

Series				BV51	BV52	BV53
	Material			HSS	HSS	Co 5%
	Type			RN	RN	RN
	Point angle			130°/C	130°/C	130°/C
	Execution			ground	ground	ground
	Finish			black	bright	bright
	d	l ₁	l ₂	price EUR		
	mm	mm	mm	each	each	each
00200	2.00	38	9.5	1,368	1,368	2,472
00250	2.50	43	9.5	1,368	1,368	2,472
00300	3.00	46	10.6	1,236	1,236	2,232
00310	3.10	49	11.2	1,296	1,296	2,328
00310	3.20	49	11.2	1,296	1,296	2,328
00325	3.25	49	11.2	1,236	1,236	2,232
00330	3.30	49	12.5	1,296	1,296	2,328
00350	3.50	52	12.5	1,428	1,428	2,568
00375	3.75	52	12.5	1,452	1,452	2,616
00380	3.80	55	14.0	1,452	1,452	2,616
00400	4.00	55	14.0	1,452	1,452	2,616
00410	4.10	55	14.0	1,452	1,452	2,616
00420	4.20	55	14.0	1,452	1,452	2,616
00425	4.25	55	14.0	1,608	1,608	2,904
00440	4.40	58	15.5	1,608	1,608	2,904
00450	4.50	58	15.5	1,608	1,608	2,904
00475	4.75	58	15.5	2,112	2,112	3,804
00480	4.80	62	17.0	2,112	2,112	3,804
00500	5.00	62	17.0	1,848	1,848	3,324
00510	5.10	62	17.0	2,120	2,120	3,820
00520	5.20	62	17.0	2,120	2,120	3,820
00550	5.50	66	19.0	2,220	2,220	3,996
00600	6.00	66	19.0	2,460	2,460	4,416
00650	6.50	70	21.2	2,640	2,640	4,752
00700	7.00	74	23.6	3,276	3,276	5,892
00800	8.00	79	25.0	3,852	3,852	6,936
01000	10.00	89	29.0	5,808	5,808	10,452

*Posebno označene stavke (**bold**) odnose se na robu koju imamo na lageru. Za ostali asortiman rabate i rokove isporuke dajemo na osnovu upita.

*Items given in **bold** figures refer to products on stock. Discount and delivery terms for other product assortment are given at request.

*Die separat gekennzeichneten artikel (**bold**) beziehen sich auf die Ware, die auf Lager liegt. Die Rabatte und Lieferzeiten für das restliche Sortiment geben wir auf Anfrage bekannt.

**SPIRALNE BURGIJE VALJKASTE,
VRLO KRATKE**

**TWIST DRILLS STRAIGHT SHANK,
STUB SERIES**

**SPIRALBOHRER ZYLINDERSCHAFT,
EXTRA KURZE**

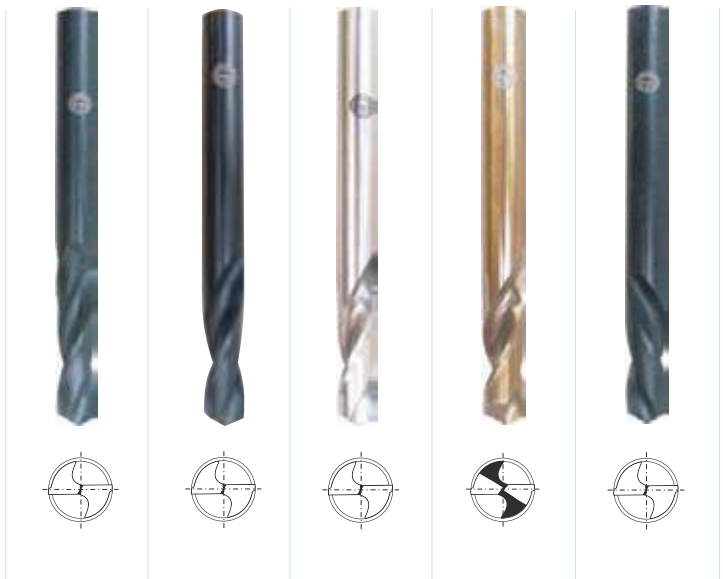
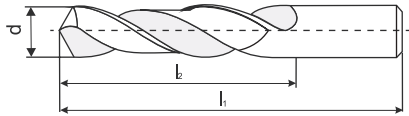

Series						BV01	BV02	BV03	BV04	BV05
	Material					HSS	HSS	HSS	Co 5%	HSS
Type					RN	RN	RN	RN	LN	
Point angle					118°	118°	118°	130°/C	118°	
Execution					rolled	ground	ground	ground	ground	
Finish					black	black	bright	gold	black	
		d	l ₁	l ₂	price EUR					
		mm	mm	mm	each	each	each	each	each	
00100		1.00	26	6	0,612	0,924	0,924	1,836	1,284	
00110		1.10	28	7	0,612	0,924	0,924	1,836	1,284	
00120		1.20	30	8	0,612	0,924	0,924	1,836	1,284	
00125		1.25	30	8	0,612	0,924	0,924	1,836	1,284	
00130		1.30	30	8	0,612	0,924	0,924	1,836	1,284	
00140		1.40	32	9	0,612	0,924	0,924	1,836	1,284	
00150		1.50	32	9	0,528	0,792	0,792	1,596	1,116	
00160		1.60	34	10	0,528	0,792	0,792	1,596	1,116	
00170		1.70	34	10	0,528	0,792	0,792	1,596	1,116	
00175		1.75	36	11	0,528	0,792	0,792	1,596	1,116	
00180		1.80	36	11	0,528	0,792	0,792	1,596	1,116	
00190		1.90	36	11	0,528	0,792	0,792	1,596	1,116	
00200		2.00	38	12	0,516	0,768	0,768	1,536	1,068	
00210		2.10	38	12	0,516	0,768	0,768	1,536	1,068	
00220		2.20	40	13	0,516	0,768	0,768	1,536	1,068	
00225		2.25	40	13	0,528	0,792	0,792	1,596	1,116	
00230		2.30	40	13	0,528	0,792	0,792	1,596	1,116	
00240		2.40	43	14	0,552	0,828	0,828	1,656	1,152	
00250		2.50	43	14	0,516	0,768	0,768	1,536	1,068	
00260		2.60	43	14	0,552	0,828	0,828	1,656	1,152	
00270		2.70	46	16	0,552	0,828	0,828	1,656	1,152	
00275		2.75	46	16	0,528	0,792	0,792	1,596	1,116	
00280		2.80	46	16	0,552	0,828	0,828	1,656	1,152	
00290		2.90	46	16	0,552	0,828	0,828	1,656	1,152	
00300		3.00	46	16	0,516	0,768	0,768	1,536	1,068	
00310		3.10	49	18	0,528	0,792	0,792	1,596	1,116	
00320		3.20	49	18	0,528	0,792	0,792	1,596	1,116	
00325		3.25	49	18	0,528	0,792	0,792	1,596	1,116	
00330		3.30	49	18	0,528	0,792	0,792	1,596	1,116	
00340		3.40	52	20	0,612	0,924	0,924	1,836	1,284	
00350		3.50	52	20	0,552	0,828	0,828	1,656	1,152	

*Posebno označene stavke (**bold**) odnose se na robu koju imamo na lageru. Za ostali asortiman rabate i rokove isporuke dajemo na osnovu upita.

*Items given in **bold** figures refer to products on stock. Discount and delivery terms for other product assortment are given at request.

*Die separat gekennzeichneten artikel (**bold**) beziehen sich auf die Ware, die auf Lager liegt. Die Rabatte und Lieferzeiten für das restliche Sortiment geben wir auf Anfrage bekannt.

Series				BV01	BV02	BV03	BV04	BV05
	Material				HSS	HSS	HSS	Co 5%
Type				RN	RN	RN	RN	LN
Point angle				118°	118°	118°	130°/C	118°
Execution				rolled	ground	ground	ground	ground
Finish				black	black	bright	gold	black
				price EUR				
	d	l ₁	l ₂					
	mm	mm	mm	each	each	each	each	each
00360	3.60	52	20	0,612	0,924	0,924	1,836	1,284
00370	3.70	52	20	0,612	0,924	0,924	1,836	1,284
00375	3.75	52	20	0,612	0,924	0,924	1,836	1,284
00380	3.80	55	22	0,612	0,924	0,924	1,836	1,284
00390	3.90	55	22	0,612	0,924	0,924	1,836	1,284
00400	4.00	55	22	0,612	0,924	0,924	1,836	1,284
00410	4.10	55	22	0,612	0,924	0,924	1,836	1,284
00420	4.20	55	22	0,612	0,924	0,924	1,836	1,284
00425	4.25	55	22	0,696	1,044	1,044	2,076	1,452
00430	4.30	58	24	0,696	1,044	1,044	2,076	1,452
00440	4.40	58	24	0,696	1,044	1,044	2,076	1,452
00450	4.50	58	24	0,696	1,044	1,044	2,076	1,452
00460	4.60	58	24	0,816	1,224	1,224	2,448	1,716
00470	4.70	58	24	0,816	1,224	1,224	2,448	1,716
00475	4.75	58	24	0,816	1,224	1,224	2,448	1,716
00480	4.80	62	26	0,816	1,224	1,224	2,448	1,716
00490	4.90	62	26	0,816	1,224	1,224	2,448	1,716
00500	5.00	62	26	0,816	1,224	1,224	2,448	1,716
00510	5.10	62	26	1,104	1,656	1,656	3,300	2,316
00520	5.20	62	26	1,104	1,656	1,656	3,300	2,316
00525	5.25	62	26	1,104	1,656	1,656	3,300	2,316
00530	5.30	62	26	1,104	1,656	1,656	3,300	2,316
00540	5.40	66	28	1,104	1,656	1,656	3,300	2,316
00550	5.50	66	28	0,996	1,500	1,500	3,000	2,100
00560	5.60	66	28	1,512	2,268	2,268	4,524	3,168
00570	5.70	66	28	1,512	2,268	2,268	4,524	3,168
00575	5.75	66	28	1,512	2,268	2,268	4,524	3,168
00580	5.80	66	28	1,512	2,268	2,268	4,524	3,168
00590	5.90	66	28	1,512	2,268	2,268	4,524	3,168
00600	6.00	66	28	1,056	1,596	1,596	3,180	2,232
00610	6.10	70	31	1,548	2,328	2,328	4,656	3,252
00620	6.20	70	31	1,548	2,328	2,328	4,656	3,252
00625	6.25	70	31	1,548	2,328	2,328	4,656	3,252
00630	6.30	70	31	1,548	2,328	2,328	4,656	3,252
00640	6.40	70	31	1,632	2,448	2,448	4,896	3,432
00650	6.50	70	31	1,164	1,740	1,740	3,492	2,436
00660	6.60	70	31	1,632	2,448	2,448	4,896	3,439
00670	6.70	70	31	1,632	2,448	2,448	4,896	3,439
00675	6.75	74	34	1,872	2,820	2,820	5,628	3,936
00680	6.80	74	34	1,872	2,820	2,820	5,628	3,936
00690	6.90	74	34	1,872	2,820	2,820	5,628	3,936
00700	7.00	74	34	1,428	2,148	2,148	4,284	3,000
00710	7.10	74	34	2,268	3,396	3,396	6,792	4,752
00720	7.20	74	34	2,268	3,396	3,396	6,792	4,752
00725	7.25	74	34	2,268	3,396	3,396	6,792	4,752
00730	7.30	74	34	2,268	3,396	3,396	6,792	4,752
00740	7.40	74	34	2,268	3,396	3,396	6,792	4,752
00750	7.50	74	34	1,536	2,292	2,292	4,596	3,216
00760	7.60	79	37	2,772	4,164	4,164	8,328	5,832
00770	7.70	79	37	2,772	4,164	4,164	8,328	5,832
00775	7.75	79	37	2,772	4,164	4,164	8,328	5,832
00780	7.80	79	37	2,772	4,164	4,164	8,328	5,832

*Posebno označene stavke (**bold**) odnose se na robu koju imamo na lageru. Za ostali asortiman rabate i rokove isporuke dajemo na osnovu upita.

*Items given in **bold** figures refer to products on stock. Discount and delivery terms for other product assortment are given at request.

*Die separat gekennzeichneten artikel (**bold**) beziehen sich auf die Ware, die auf Lager liegt. Die Rabatte und Lieferzeiten für das restliche Sortiment geben wir auf Anfrage bekannt.

Series	BV01		BV02		BV03		BV04		BV05	
	Material	HSS	HSS	HSS	Co 5%	HSS	Type	RN	RN	LN
Point angle	118°	118°	118°	130°/C	118°	Execution	rolled	ground	ground	ground
Finish	black	black	bright	gold	black	price EUR				
d	l ₁	l ₂								
mm	mm	mm	each	each	each	each	each			
00790	7.90	79	37	2,772	4,164	4,164	8,328	5,832		
00800	8.00	79	37	1,668	2,508	2,508	5,016	3,516		
00810	8.10	79	37	2,856	4,284	4,284	8,568	6,000		
00820	8.20	79	37	2,856	4,284	4,284	8,568	6,000		
00825	8.25	79	37	2,856	4,284	4,284	8,568	6,000		
00830	8.30	79	37	2,856	4,284	4,284	8,568	6,000		
00840	8.40	79	37	2,856	4,284	4,284	8,568	6,000		
00850	8.50	79	37	2,328	3,492	3,492	6,972	4,884		
00860	8.60	84	40	2,976	4,464	4,464	8,940	6,252		
00870	8.70	84	40	2,976	4,464	4,464	8,940	6,252		
00875	8.75	84	40	2,976	4,464	4,464	8,940	6,252		
00880	8.80	84	40	2,976	4,464	4,464	8,940	6,252		
00890	8.90	84	40	2,976	4,464	4,464	8,940	6,252		
00900	9.00	84	40	2,328	3,492	3,492	6,972	4,884		
00910	9.10	84	40	3,912	5,880	5,880	11,748	8,220		
00920	9.20	84	40	3,912	5,880	5,880	11,748	8,220		
00925	9.25	84	40	3,912	5,880	5,880	11,748	8,220		
00930	9.30	84	40	3,912	5,880	5,880	11,748	8,220		
00940	9.40	84	40	3,912	5,880	5,880	11,748	8,220		
00950	9.50	84	40	3,468	5,208	5,208	10,404	7,284		
00960	9.60	89	43	4,608	6,912	6,912	13,836	9,684		
00970	9.70	89	43	4,608	6,912	6,912	13,836	9,684		
00975	9.75	89	43	4,608	6,912	6,912	13,836	9,684		
00980	9.80	89	43	4,608	6,912	6,912	13,836	9,684		
00990	9.90	89	43	4,608	6,912	6,912	13,836	9,684		
01000	10.00	89	43	3,468	5,208	5,208	10,404	7,284		
01020	10.20	89	43	4,488	6,732	6,732	13,464	9,420		
01025	10.25	89	43	4,488	6,732	6,732	13,464	9,420		
01050	10.50	89	43	4,488	6,732	6,732	13,464	9,420		
01075	10.75	95	43	4,896	7,344	7,344	14,688	10,284		
01080	10.80	95	47	4,896	7,344	7,344	14,688	10,284		
01100	11.00	95	47	4,896	7,344	7,344	14,688	10,284		
01125	11.25	95	47	5,100	7,656	7,656	15,300	10,716		
01150	11.50	95	47	5,100	7,656	7,656	15,300	10,716		
01175	11.75	95	47	5,712	8,568	8,568	17,136	12,000		
01200	12.00	102	51	5,712	8,568	8,568	17,136	12,000		
01250	12.50	102	51	5,832	8,748	8,748	17,508	12,252		
01300	13.00	102	51	5,832	8,748	8,748	17,508	12,252		
01350	13.50	107	54	6,732	10,104	10,104	20,196	14,136		
01400	14.00	107	54	6,732	10,104	10,104	20,196	14,136		
01450	14.50	111	56	7,344	11,016	11,016	22,032	15,420		
01500	15.00	111	56	7,344	11,016	11,016	22,032	15,420		
01550	15.50	115	58	8,568	12,852	12,852	25,704	17,988		
01600	16.00	115	58	8,568	12,852	12,852	25,704	17,988		
01650	16.50	119	60	10,200	15,300	15,300	30,600	21,420		
01700	17.00	119	60	10,200	15,300	15,300	30,600	21,420		
01750	17.50	123	62	11,016	16,524	16,524	33,048	23,136		
01800	18.00	123	62	11,016	16,524	16,524	33,048	23,136		
01850	18.50	127	64	12,240	18,360	18,360	36,720	25,704		
01900	19.00	127	64	12,240	18,360	18,360	36,720	25,704		
01950	19.50	131	66	13,056	19,584	19,584	39,168	27,420		
02000	20.00	131	66	13,056	19,584	19,584	39,168	27,420		

*Posebno označene stavke (**bold**) odnose se na robu koju imamo na lageru. Za ostali asortiman rabate i rokove isporuke dajemo na osnovu upita.

*Items given in **bold** figures refer to products on stock. Discount and delivery terms for other product assortment are given at request.

*Die separat gekennzeichneten artikel (**bold**) beziehen sich auf die Ware, die auf Lager liegt. Die Rabatte und Lieferzeiten für das restliche Sortiment geben wir auf Anfrage bekannt.

SPIRALNE BURGIJE VALJKASTE, KRATKE

TWIST DRILLS STRAIGHT SHANK, JOBBER LENGTH

SPIRALBOHRER ZYLINDERSCHAFT, KURZE



Series	price EUR											
	Material	BV11	BV12	BV13	BV14	BV15	BV16	BV17	BV18	BV19		
	Material	HSS	HSS	HSS	HSS	HSS	HSS	HSS	HSS	HSS		
	Type	RN	RN	RN	RN	LN	RH	RW	RH	RW		
	Point angle	118°	118°	118°	118°	118°	118°	118°	118°	118°		
	Execution	rolled	rolled	ground	ground	ground	ground	ground	ground	ground		
	Finish	black	b/b	bright	black	black	black	black	bright	bright		
	d	l ₁	l ₂									
	mm	mm	mm	each	each	each	each	each	each	each	each	
00030	0.30	19	3			1,620	1,620	2,268	2,112	2,112	2,112	
00040	0.40	20	5			1,308	1,308	1,836	1,704	1,704	1,704	
00050	0.50	22	6			1,056	1,056	1,488	1,380	1,380	1,380	
00055	0.55	24	7			1,212	1,212	1,704	1,584	1,584	1,584	
00060	0.60	24	7			1,128	1,128	1,572	1,464	1,464	1,464	
00065	0.65	26	8			1,188	1,188	1,656	1,536	1,536	1,536	
00070	0.70	28	9			1,188	1,188	1,656	1,536	1,536	1,536	
00075	0.75	28	9			1,128	1,128	1,572	1,464	1,464	1,464	
00080	0.80	30	10			1,032	1,032	1,440	1,344	1,344	1,344	
00085	0.85	30	10			1,032	1,032	1,440	1,344	1,344	1,344	
00090	0.90	32	11			1,032	1,032	1,440	1,344	1,344	1,344	
00095	0.95	32	11			1,032	1,032	1,440	1,344	1,344	1,344	
00100	1.00	34	12			0,876	0,876	1,224	1,140	1,140	1,140	
00110	1.10	36	14			0,816	0,816	1,140	1,056	1,056	1,056	
00120	1.20	38	14			0,936	0,936	1,308	1,212	1,212	1,212	
00125	1.25	38	14			0,876	0,876	1,224	1,140	1,140	1,140	
00130	1.30	38	14			0,816	0,816	1,140	1,056	1,056	1,056	
00140	1.40	40	18			0,780	0,780	1,092	1,020	1,020	1,020	
00150	1.50	40	18	0,348	0,372	0,684	0,684	0,960	0,888	0,888	0,888	
00160	1.60	43	20	0,360	0,396	0,720	0,720	1,008	0,936	0,936	0,936	
00170	1.70	43	20	0,396	0,432	0,780	0,780	1,092	1,020	1,020	1,020	
00175	1.75	46	22	0,396	0,432	0,780	0,780	1,092	1,020	1,020	1,020	
00180	1.80	46	22	0,348	0,372	0,684	0,684	0,960	0,888	0,888	0,888	
00190	1.90	46	22	0,348	0,372	0,684	0,684	0,960	0,888	0,888	0,888	
00200	2.00	49	24	0,312	0,348	0,624	0,624	0,876	0,816	0,816	0,816	
00210	2.10	49	24	0,312	0,348	0,624	0,624	0,876	0,816	0,816	0,816	
00220	2.20	53	27	0,312	0,348	0,624	0,624	0,876	0,816	0,816	0,816	
00225	2.25	53	27	0,348	0,372	0,684	0,684	0,960	0,888	0,888	0,888	
00230	2.30	53	27	0,312	0,348	0,624	0,624	0,876	0,816	0,816	0,816	
00240	2.40	57	30	0,348	0,372	0,684	0,684	0,960	0,888	0,888	0,888	
00250	2.50	57	30	0,348	0,372	0,684	0,684	0,960	0,888	0,888	0,888	
00260	2.60	57	30	0,348	0,372	0,684	0,684	0,960	0,888	0,888	0,888	

*Posebno označene stavke (**bold**) odnose se na robu koju imamo na lageru. Za ostali asortiman rabate i rokove isporuke dajemo na osnovu upita.

*Items given in **bold** figures refer to products on stock. Discount and delivery terms for other product assortment are given at request.

*Die separat gekennzeichneten artikel (**bold**) beziehen sich auf die Ware, die auf Lager liegt. Die Rabatte und Lieferzeiten für das restliche Sortiment geben wir auf Anfrage bekannt.

Series												
	Material	BV11	BV12	BV13	BV14	BV15	BV16	BV17	BV18	BV19		
Type	RN	RN	RN	RN	LN	RH	RW	RH	RW			
Point angle	118°	118°	118°	118°	118°	118°	118°	118°	118°	118°		
Execution	rolled	rolled	ground	ground	ground	ground	ground	ground	ground	ground		
Finish	black	b/b	bright	black	black	black	black	black	bright	bright		
d	l ₁	l ₂	price EUR									
mm	mm	mm	each	each	each	each	each	each	each	each	each	
00270	2.70	61	33	0,348	0,372	0,684	0,684	0,960	0,888	0,888	0,888	0,888
00275	2.75	61	33	0,348	0,372	0,684	0,684	0,960	0,888	0,888	0,888	0,888
00280	2.80	61	33	0,348	0,372	0,684	0,684	0,960	0,888	0,888	0,888	0,888
00290	2.90	61	33	0,348	0,372	0,684	0,684	0,960	0,888	0,888	0,888	0,888
00300	3.00	61	33	0,348	0,372	0,684	0,684	0,960	0,888	0,888	0,888	0,888
00310	3.10	65	36	0,348	0,372	0,684	0,684	0,960	0,888	0,888	0,888	0,888
00320	3.20	65	36	0,348	0,372	0,684	0,684	0,960	0,888	0,888	0,888	0,888
00325	3.25	65	36	0,408	0,444	0,816	0,816	1,140	1,056	1,056	1,056	1,056
00330	3.30	65	36	0,408	0,444	0,816	0,816	1,140	1,056	1,056	1,056	1,056
00340	3.40	70	39	0,420	0,468	0,840	0,840	1,176	1,092	1,092	1,092	1,092
00350	3.50	70	39	0,420	0,468	0,840	0,840	1,176	1,092	1,092	1,092	1,092
00360	3.60	70	39	0,432	0,480	0,876	0,876	1,224	1,140	1,140	1,140	1,140
00370	3.70	70	39	0,432	0,480	0,876	0,876	1,224	1,140	1,140	1,140	1,140
00375	3.75	70	39	0,504	0,552	0,996	0,996	1,392	1,296	1,296	1,296	1,296
00380	3.80	75	43	0,504	0,552	0,996	0,996	1,392	1,296	1,296	1,296	1,296
00390	3.90	75	43	0,504	0,552	0,996	0,996	1,392	1,296	1,296	1,296	1,296
00400	4.00	75	43	0,468	0,516	0,936	0,936	1,308	1,212	1,212	1,212	1,212
00410	4.10	75	43	0,516	0,564	1,032	1,032	1,440	1,344	1,344	1,344	1,344
00420	4.20	75	43	0,516	0,564	1,032	1,032	1,440	1,344	1,344	1,344	1,344
00425	4.25	75	43	0,552	0,600	1,092	1,092	1,524	1,416	1,416	1,416	1,416
00430	4.30	80	47	0,552	0,600	1,092	1,092	1,524	1,416	1,416	1,416	1,416
00440	4.40	80	47	0,552	0,600	1,092	1,092	1,524	1,416	1,416	1,416	1,416
00450	4.50	80	47	0,528	0,588	1,056	1,056	1,488	1,380	1,380	1,380	1,380
00460	4.60	80	47	0,552	0,600	1,092	1,092	1,524	1,416	1,416	1,416	1,416
00470	4.70	80	47	0,552	0,600	1,092	1,092	1,524	1,416	1,416	1,416	1,416
00475	4.75	80	47	0,576	0,636	1,152	1,152	1,620	1,500	1,500	1,500	1,500
00480	4.80	86	52	0,576	0,636	1,152	1,152	1,620	1,500	1,500	1,500	1,500
00490	4.90	86	52	0,576	0,636	1,152	1,152	1,620	1,500	1,500	1,500	1,500
00500	5.00	86	52	0,576	0,636	1,152	1,152	1,620	1,500	1,500	1,500	1,500
00510	5.10	86	52	0,636	0,708	1,284	1,284	1,788	1,668	1,668	1,668	1,668
00520	5.20	86	52	0,636	0,708	1,284	1,284	1,788	1,668	1,668	1,668	1,668
00525	5.25	86	52	0,636	0,708	1,284	1,284	1,788	1,668	1,668	1,668	1,668
00530	5.30	86	52	0,636	0,708	1,284	1,284	1,788	1,668	1,668	1,668	1,668
00540	5.40	93	57	0,780	0,864	1,560	1,560	2,184	2,028	2,028	2,028	2,028
00550	5.50	93	57	0,780	0,864	1,560	1,560	2,184	2,028	2,028	2,028	2,028
00560	5.60	93	57	0,780	0,864	1,560	1,560	2,184	2,028	2,028	2,028	2,028
00570	5.70	93	57	0,780	0,864	1,560	1,560	2,184	2,028	2,028	2,028	2,028
00575	5.75	93	57	0,780	0,864	1,560	1,560	2,184	2,028	2,028	2,028	2,028
00580	5.80	93	57	0,780	0,864	1,560	1,560	2,184	2,028	2,028	2,028	2,028
00590	5.90	93	57	0,780	0,864	1,560	1,560	2,184	2,028	2,028	2,028	2,028
00600	6.00	93	57	0,780	0,864	1,560	1,560	2,184	2,028	2,028	2,028	2,028
00610	6.10	101	63	1,248	1,376	2,512	2,512	3,520	3,264	3,264	3,264	3,264
00620	6.20	101	63	1,248	1,376	2,512	2,512	3,520	3,264	3,264	3,264	3,264
00625	6.25	101	63	1,248	1,376	2,512	2,512	3,520	3,264	3,264	3,264	3,264
00630	6.30	101	63	1,248	1,376	2,512	2,512	3,520	3,264	3,264	3,264	3,264
00640	6.40	101	63	1,344	1,472	2,688	2,688	3,760	3,488	3,488	3,488	3,488
00650	6.50	101	63	1,344	1,472	2,688	2,688	3,760	3,488	3,488	3,488	3,488
00660	6.60	101	63	1,344	1,472	2,688	2,688	3,760	3,488	3,488	3,488	3,488
00670	6.70	101	63	1,344	1,472	2,688	2,688	3,760	3,488	3,488	3,488	3,488
00675	6.75	109	69	1,728	1,904	3,456	3,456	4,832	4,480	4,480	4,480	4,480
00680	6.80	109	69	1,728	1,904	3,456	3,456	4,832	4,480	4,480	4,480	4,480

*Posebno označene stavke (**bold**) odnose se na robu koju imamo na lageru. Za ostali asortiman rabate i rokove isporuke dajemo na osnovu upita.

*Items given in **bold** figures refer to products on stock. Discount and delivery terms for other product assortment are given at request.

*Die separat gekennzeichneten artikel (**bold**) beziehen sich auf die Ware, die auf Lager liegt. Die Rabatte und Lieferzeiten für das restliche Sortiment geben wir auf Anfrage bekannt.

Series				BV11	BV12	BV13	BV14	BV15	BV16	BV17	BV18	BV19
	Material				HSS	HSS	HSS	HSS	HSS	HSS	HSS	HSS
Type				RN	RN	RN	RN	LN	RH	RW	RH	RW
Point angle				118°	118°	118°	118°	118°	118°	118°	118°	118°
Execution				rolled	rolled	ground	ground	ground	ground	ground	ground	ground
Finish				black	b/b	bright	black	black	black	black	bright	bright
				price EUR								
d	l ₁	l ₂		each	each	each	each	each	each	each	each	each
mm	mm	mm		each	each	each	each	each	each	each	each	each
00690	6.90	109	69	1,728	1,904	3,456	3,456	4,832	4,480	4,480	4,480	4,480
00700	7.00	109	69	1,616	1,776	3,232	3,232	4,512	4,192	4,192	4,192	4,192
00710	7.10	109	69	1,744	1,920	3,488	3,488	4,896	4,544	4,544	4,544	4,544
00720	7.20	109	69	1,808	2,000	3,632	3,632	5,088	4,720	4,720	4,720	4,720
00725	7.25	109	69	1,808	2,000	3,632	3,632	5,088	4,720	4,720	4,720	4,720
00730	7.30	109	69	1,808	2,000	3,632	3,632	5,088	4,720	4,720	4,720	4,720
00740	7.40	109	69	1,808	2,000	3,632	3,632	5,088	4,720	4,720	4,720	4,720
00750	7.50	109	69	1,808	2,000	3,632	3,632	5,088	4,720	4,720	4,720	4,720
00760	7.60	117	75	1,952	2,144	3,904	3,904	5,456	5,072	5,072	5,072	5,072
00770	7.70	117	75	1,952	2,144	3,904	3,904	5,456	5,072	5,072	5,072	5,072
00775	7.75	117	75	1,952	2,144	3,904	3,904	5,456	5,072	5,072	5,072	5,072
00780	7.80	117	75	1,952	2,144	3,904	3,904	5,456	5,072	5,072	5,072	5,072
00790	7.90	117	75	1,952	2,144	3,904	3,904	5,456	5,072	5,072	5,072	5,072
00800	8.00	117	75	1,952	2,144	3,904	3,904	5,456	5,072	5,072	5,072	5,072
00810	8.10	117	75	2,080	2,288	4,160	4,160	5,840	5,424	5,424	5,424	5,424
00820	8.20	117	75	2,080	2,288	4,160	4,160	5,840	5,424	5,424	5,424	5,424
00825	8.25	117	75	2,080	2,288	4,160	4,160	5,840	5,424	5,424	5,424	5,424
00830	8.30	117	75	2,080	2,288	4,160	4,160	5,840	5,424	5,424	5,424	5,424
00840	8.40	117	75	2,080	2,288	4,160	4,160	5,840	5,424	5,424	5,424	5,424
00850	8.50	117	75	2,064	2,272	4,128	4,128	5,776	5,360	5,360	5,360	5,360
00860	8.60	125	81	2,528	2,784	5,056	5,056	7,088	6,576	6,576	6,576	6,576
00870	8.70	125	81	2,528	2,784	5,056	5,056	7,088	6,576	6,576	6,576	6,576
00875	8.75	125	81	2,528	2,784	5,056	5,056	7,088	6,576	6,576	6,576	6,576
00880	8.80	125	81	2,528	2,784	5,056	5,056	7,088	6,576	6,576	6,576	6,576
00890	8.90	125	81	2,528	2,784	5,056	5,056	7,088	6,576	6,576	6,576	6,576
00900	9.00	125	81	2,528	2,784	5,056	5,056	7,088	6,576	6,576	6,576	6,576
00910	9.10	125	81	2,560	2,816	5,104	5,104	7,152	6,640	6,640	6,640	6,640
00920	9.20	125	81	2,560	2,816	5,104	5,104	7,152	6,640	6,640	6,640	6,640
00925	9.25	125	81	2,736	3,008	5,472	5,472	7,648	7,104	7,104	7,104	7,104
00930	9.30	125	81	2,736	3,008	5,472	5,472	7,648	7,104	7,104	7,104	7,104
00940	9.40	125	81	2,736	3,008	5,472	5,472	7,648	7,104	7,104	7,104	7,104
00950	9.50	125	81	2,736	3,008	5,472	5,472	7,648	7,104	7,104	7,104	7,104
00960	9.60	133	87	2,912	3,200	5,824	5,824	8,144	7,568	7,568	7,568	7,568
00970	9.70	133	87	2,912	3,200	5,824	5,824	8,144	7,568	7,568	7,568	7,568
00975	9.75	133	87	3,008	3,296	6,000	6,000	8,400	7,808	7,808	7,808	7,808
00980	9.80	133	87	3,008	3,296	6,000	6,000	8,400	7,808	7,808	7,808	7,808
00990	9.90	133	87	3,008	3,296	6,000	6,000	8,400	7,808	7,808	7,808	7,808
01000	10.00	133	87	3,008	3,296	6,000	6,000	8,400	7,808	7,808	7,808	7,808
01010	10.10	133	87	3,312	3,648	6,624	6,624	9,280	8,624	8,624	8,624	8,624
01020	10.20	133	87	3,312	3,648	6,624	6,624	9,280	8,624	8,624	8,624	8,624
01025	10.25	133	87	3,760	4,144	7,520	7,520	10,544	9,792	9,792	9,792	9,792
01030	10.30	133	87	3,760	4,144	7,520	7,520	10,544	9,792	9,792	9,792	9,792
01040	10.40	133	87	3,760	4,144	7,520	7,520	10,544	9,792	9,792	9,792	9,792
01050	10.50	133	87	3,760	4,144	7,520	7,520	10,544	9,792	9,792	9,792	9,792
01060	10.60	142	94	4,128	4,528	8,240	8,240	11,536	10,720	10,720	10,720	10,720
01070	10.70	142	94	4,128	4,528	8,240	8,240	11,536	10,720	10,720	10,720	10,720
01075	10.75	142	94	4,416	4,848	8,400	8,400	12,352	11,472	11,472	11,472	11,472
01080	10.80	142	94	4,416	4,848	8,400	8,400	12,352	11,472	11,472	11,472	11,472
01090	10.90	142	94	4,416	4,848	8,400	8,400	12,352	11,472	11,472	11,472	11,472
01100	11.00	142	94	4,416	4,848	8,400	8,400	12,352	11,472	11,472	11,472	11,472
01110	11.10	142	94	4,528	4,976	9,056	9,056	12,672	11,760	11,760	11,760	11,760

*Posebno označene stavke (**bold**) odnose se na robu koju imamo na lageru. Za ostali asortiman rabate i rokove isporuke dajemo na osnovu upita.

*Items given in **bold** figures refer to products on stock. Discount and delivery terms for other product assortment are given at request.

*Die separat gekennzeichneten artikel (**bold**) beziehen sich auf die Ware, die auf Lager liegt. Die Rabatte und Lieferzeiten für das restliche Sortiment geben wir auf Anfrage bekannt.

Series											BV11	BV12	BV13	BV14	BV15	BV16	BV17	BV18	BV19
	Material			HSS	HSS	HSS	HSS	HSS	HSS	HSS	HSS	HSS	HSS	HSS	HSS				
	Type			RN	RN	RN	RN	LN	RH	RW	RH	RW	RH	RW					
	Point angle			118°	118°	118°	118°	118°	118°	118°	118°	118°	118°	118°					
	Execution			rolled	rolled	ground	ground	ground	ground	ground	ground	ground	ground	ground					
	Finish			black	b/b	bright	black	black	black	black	black	bright	bright	bright					
d			price EUR																
mm			l ₁	l ₂	each	each	each	each	each	each	each	each	each						
mm			mm	mm	each	each	each	each	each	each	each	each	each						
01120	11.20	142	94	4,528	4,976	9,056	9,056	12,672	11,760	11,760	11,760	11,760							
01125	11.25	142	94	4,608	5,072	9,232	9,232	12,928	12,000	12,000	12,000	12,000							
01130	11.30	142	94	4,608	5,072	9,232	9,232	12,928	12,000	12,000	12,000	12,000							
01140	11.40	142	94	4,608	5,072	9,232	9,232	12,928	12,000	12,000	12,000	12,000							
01150	11.50	142	94	4,608	5,072	9,232	9,232	12,928	12,000	12,000	12,000	12,000							
01160	11.60	142	94	4,864	5,344	9,728	9,728	13,616	12,640	12,640	12,640	12,640							
01170	11.70	142	94	4,864	5,344	9,728	9,728	13,616	12,640	12,640	12,640	12,640							
01175	11.75	142	94	5,104	5,616	10,208	10,208	14,304	13,280	13,280	13,280	13,280							
01180	11.80	142	94	5,104	5,616	10,208	10,208	14,304	13,280	13,280	13,280	13,280							
01190	11.90	151	101	5,104	5,616	10,208	10,208	14,304	13,280	13,280	13,280	13,280							
01200	12.00	151	101	5,104	5,616	10,208	10,208	14,304	13,280	13,280	13,280	13,280							
01210	12.10	151	101	5,360	5,888	10,704	10,704	14,992	13,920	13,920	13,920	13,920							
01220	12.20	151	101	5,360	5,888	10,704	10,704	14,992	13,920	13,920	13,920	13,920							
01225	12.25	151	101	5,584	6,128	11,152	11,152	15,616	14,496	14,496	14,496	14,496							
01230	12.30	151	101	5,584	6,128	11,152	11,152	15,616	14,496	14,496	14,496	14,496							
01240	12.40	151	101	5,584	6,128	11,152	11,152	15,616	14,496	14,496	14,496	14,496							
01250	12.50	151	101	5,584	6,128	11,152	11,152	15,616	14,496	14,496	14,496	14,496							
01260	12.60	151	101	5,648	6,208	11,296	11,296	15,808	14,672	14,672	14,672	14,672							
01270	12.70	151	101	5,648	6,208	11,296	11,296	15,808	14,672	14,672	14,672	14,672							
01275	12.75	151	101	5,696	6,256	11,376	11,376	15,936	14,800	14,800	14,800	14,800							
01280	12.80	151	101	5,696	6,256	11,376	11,376	15,936	14,800	14,800	14,800	14,800							
01290	12.90	151	101	5,696	6,256	11,376	11,376	15,936	14,800	14,800	14,800	14,800							
01300	13.00	151	101	5,696	6,256	11,376	11,376	15,936	14,800	14,800	14,800	14,800							
01325	13.25	160	108	8,316	9,144	16,632	16,632	23,292	21,618	21,618	21,618	21,618							
01350	13.50	160	108	8,316	9,144	16,632	16,632	23,292	21,618	21,618	21,618	21,618							
01375	13.75	160	108	8,316	9,144	16,632	16,632	23,292	21,618	21,618	21,618	21,618							
01400	14.00	160	108	8,316	9,144	16,632	16,632	23,292	21,618	21,618	21,618	21,618							
01425	14.25	169	114	9,648	10,620	19,296	19,296	27,018	25,092	25,092	25,092	25,092							
01450	14.50	169	114	9,648	10,620	19,296	19,296	27,018	25,092	25,092	25,092	25,092							
01475	14.75	169	114	9,648	10,620	19,296	19,296	27,018	25,092	25,092	25,092	25,092							
01500	15.00	169	114	9,648	10,620	19,296	19,296	27,018	25,092	25,092	25,092	25,092							
01525	15.25	178	120	11,340	12,474	22,680	22,680	31,752	29,484	29,484	29,484	29,484							
01550	15.50	178	120	11,340	12,474	22,680	22,680	31,752	29,484	29,484	29,484	29,484							
01575	15.75	178	120	12,096	13,302	24,192	24,192	33,876	31,446	31,446	31,446	31,446							
01600	16.00	178	120	12,096	13,302	24,192	24,192	33,876	31,446	31,446	31,446	31,446							
01625	16.25	184	125	13,230	14,562	26,460	26,460	37,044	34,398	34,398	34,398	34,398							
01650	16.50	184	125	13,230	14,562	26,460	26,460	37,044	34,398	34,398	34,398	34,398							
01675	16.75	184	125	13,230	14,562	26,460	26,460	37,044	34,398	34,398	34,398	34,398							
01700	17.00	184	125	13,230	14,562	26,460	26,460	37,044	34,398	34,398	34,398	34,398							
01725	17.25	191	130	14,940	16,434	29,880	29,880	41,850	38,862	38,862	38,862	38,862							
01750	17.50	191	130	14,940	16,434	29,880	29,880	41,850	38,862	38,862	38,862	38,862							
01775	17.75	191	130	14,940	16,434	29,880	29,880	41,850	38,862	38,862	38,862	38,862							
01800	18.00	191	130	14,940	16,434	29,880	29,880	41,850	38,862	38,862	38,862	38,862							
01825	18.25	198	135	17,388	19,134	34,776	34,776	48,690	45,216	45,216	45,216	45,216							
01850	18.50	198	135	17,388	19,134	34,776	34,776	48,690	45,216	45,216	45,216	45,216							
01875	18.75	198	135	17,388	19,134	34,776	34,776	48,690	45,216	45,216	45,216	45,216							
01900	19.00	198	135	17,388	19,134	34,776	34,776	48,690	45,216	45,216	45,216	45,216							
01925	19.25	205	140	18,900	20,790	37,800	37,800	52,920	49,140	49,140	49,140	49,140							
01950	19.50	205	140	18,900	20,790	37,800	37,800	52,920	49,140	49,140	49,140	49,140							
01975	19.75	205	140	18,900	20,790	37,800	37,800	52,920	49,140	49,140	49,140	49,140							
02000	20.00	205	140	18,900	20,790	37,800	37,800	52,920	49,140	49,140	49,140	49,140							

*Posebno označene stavke (**bold**) odnose se na robu koju imamo na lageru. Za ostali asortiman rabate i rokove isporuke dajemo na osnovu upita.

*Items given in **bold** figures refer to products on stock. Discount and delivery terms for other product assortment are given at request.

*Die separat gekennzeichneten artikel (**bold**) beziehen sich auf die Ware, die auf Lager liegt. Die Rabatte und Lieferzeiten für das restliche Sortiment geben wir auf Anfrage bekannt.

SPIRALNE BURGJE VALJKASTE, KRATKE

TWIST DRILLS STRAIGHT SHANK, JOBBER LENGTH

SPIRALBOHRER ZYLINDERSCHAFT, KURZE

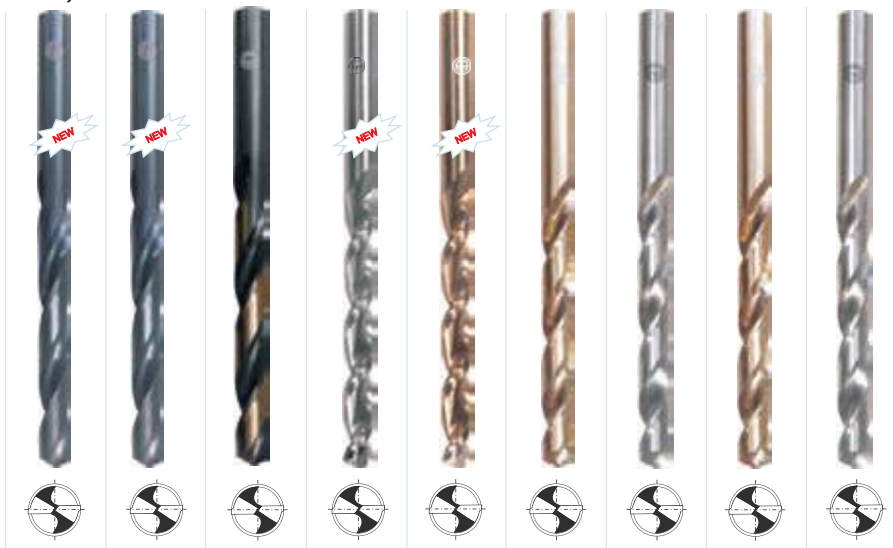
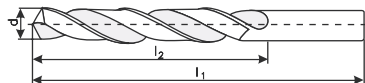

Series	BV20	BV21	BV22	BV23	BV25	BV26	BV27	BV28	BV29			
Material	HSS	HSS	HSS	HSS	Co 5%	Co 5%	Co 5%	Co 8%	Co 8%			
Type	RN	RN	RN	RS	RS	RN	RN	RN	RN			
Point angle	130°/C	130°/C	130°/C	130°/C	130°/C	130°/C	130°/C	130°/C	130°/C			
Execution	ground	ground	ground	ground	ground	ground	ground	ground	ground			
Finish	black	black/b	b/g	bright	gold	gold	bright	gold	bright			
	d	l ₁	l ₂	price EUR								
	mm	mm	mm	each	each	each	each	each	each	each	each	
00030	0.30	19	3	1,847	1,847	1,944	2,216	3,312	2,760	2,760	3,456	3,456
00040	0.40	20	5	1,493	1,493	1,572	1,792	2,678	2,232	2,232	2,796	2,796
00050	0.50	22	6	1,208	1,208	1,272	1,450	2,160	1,800	1,800	2,256	2,256
00055	0.55	24	7	1,391	1,391	1,464	1,669	2,477	2,064	2,064	2,580	2,580
00060	0.60	24	7	1,277	1,277	1,344	1,532	2,290	1,908	1,908	2,388	2,388
00065	0.65	26	8	1,357	1,357	1,428	1,628	2,419	2,016	2,016	2,520	2,520
00070	0.70	28	9	1,357	1,357	1,428	1,628	2,419	2,016	2,016	2,520	2,520
00075	0.75	28	9	1,277	1,277	1,344	1,532	2,290	1,908	1,908	2,388	2,388
00080	0.80	30	10	1,174	1,174	1,236	1,409	2,102	1,752	1,752	2,196	2,196
00085	0.85	30	10	1,174	1,174	1,236	1,409	2,102	1,752	1,752	2,196	2,196
00090	0.90	32	11	1,174	1,174	1,236	1,409	2,102	1,752	1,752	2,196	2,196
00095	0.95	32	11	1,174	1,174	1,236	1,409	2,102	1,752	1,752	2,196	2,196
00100	1.00	34	12	0,992	0,992	1,044	1,190	1,786	1,488	1,488	1,860	1,860
00110	1.10	36	14	0,923	0,923	0,972	1,108	1,656	1,380	1,380	1,728	1,728
00120	1.20	38	14	1,072	1,072	1,128	1,286	1,915	1,596	1,596	1,992	1,992
00125	1.25	38	14	0,992	0,992	1,044	1,190	1,786	1,488	1,488	1,860	1,860
00130	1.30	38	14	0,923	0,923	0,972	1,108	1,656	1,380	1,380	1,728	1,728
00140	1.40	40	18	0,889	0,889	0,936	1,067	1,598	1,332	1,332	1,668	1,668
00150	1.50	40	18	0,787	0,787	0,828	0,944	1,397	1,164	1,164	1,452	1,452
00160	1.60	43	20	0,821	0,821	0,864	0,985	1,469	1,224	1,224	1,536	1,536
00170	1.70	43	20	0,889	0,889	0,936	1,067	1,598	1,332	1,332	1,668	1,668
00175	1.75	46	22	0,889	0,889	0,936	1,067	1,598	1,332	1,332	1,668	1,668
00180	1.80	46	22	0,787	0,787	0,828	0,944	1,397	1,164	1,164	1,452	1,452
00190	1.90	46	22	0,787	0,787	0,828	0,944	1,397	1,164	1,164	1,452	1,452
00200	2.00	49	24	0,707	0,707	0,744	0,848	1,267	1,056	1,056	1,320	1,320
00210	2.10	49	24	0,707	0,707	0,744	0,848	1,267	1,056	1,056	1,320	1,320
00220	2.20	53	27	0,707	0,707	0,744	0,848	1,267	1,056	1,056	1,320	1,320
00225	2.25	53	27	0,787	0,787	0,828	0,944	1,397	1,164	1,164	1,452	1,452
00230	2.30	53	27	0,707	0,707	0,744	0,848	1,267	1,056	1,056	1,320	1,320
00240	2.40	57	30	0,787	0,787	0,828	0,944	1,397	1,164	1,164	1,452	1,452
00250	2.50	57	30	0,787	0,787	0,828	0,944	1,397	1,164	1,164	1,452	1,452
00260	2.60	57	30	0,787	0,787	0,828	0,944	1,397	1,164	1,164	1,452	1,452

*Posebno označene stavke (bold) odnose se na robu koju imamo na lageru. Za ostali asortiman rabate i rokove isporuke dajemo na osnovu upita.

*Items given in bold figures refer to products on stock. Discount and delivery terms for other product assortment are given at request.

*Die separat gekennzeichneten artikel (bold) beziehen sich auf die Ware, die auf Lager liegt. Die Rabatte und Lieferzeiten für das restliche Sortiment geben wir auf Anfrage bekannt.

Series	BV20	BV21	BV22	BV23	BV25	BV26	BV27	BV28	BV29			
Material	HSS	HSS	HSS	HSS	Co 5%	Co 5%	Co 5%	Co 8%	Co 8%			
Type	RN	RN	RN	RS	RS	RN	RN	RN	RN			
Point angle	130°/C	130°/C	130°/C	130°/C	130°/C	130°/C	130°/C	130°/C	130°/C			
Execution	ground	ground	ground	ground	ground	ground	ground	ground	ground			
Finish	black	black/b	b/g	bright	gold	gold	bright	gold	bright			
	d	l ₁	l ₂	price EUR								
	mm	mm	mm	each	each	each	each	each	each	each	each	each
00270	2.70	61	33	0,787	0,787	0,828	0,944	1,397	1,164	1,164	1,452	1,452
00275	2.75	61	33	0,787	0,787	0,828	0,944	1,397	1,164	1,164	1,452	1,452
00280	2.80	61	33	0,787	0,787	0,828	0,944	1,397	1,164	1,164	1,452	1,452
00290	2.90	61	33	0,787	0,787	0,828	0,944	1,397	1,164	1,164	1,452	1,452
00300	3.00	61	33	0,787	0,787	0,828	0,944	1,397	1,164	1,164	1,452	1,452
00310	3.10	65	36	0,787	0,787	0,828	0,944	1,397	1,164	1,164	1,452	1,452
00320	3.20	65	36	0,787	0,787	0,828	0,944	1,397	1,164	1,164	1,452	1,452
00325	3.25	65	36	0,923	0,923	0,972	1,108	1,656	1,380	1,380	1,728	1,728
00330	3.30	65	36	0,923	0,923	0,972	1,108	1,656	1,380	1,380	1,728	1,728
00340	3.40	70	39	0,958	0,958	1,008	1,149	1,714	1,428	1,428	1,788	1,788
00350	3.50	70	39	0,958	0,958	1,008	1,149	1,714	1,428	1,428	1,788	1,788
00360	3.60	70	39	0,992	0,992	1,044	1,190	1,786	1,488	1,488	1,860	1,860
00370	3.70	70	39	0,992	0,992	1,044	1,190	1,786	1,488	1,488	1,860	1,860
00375	3.75	70	39	1,140	1,140	1,200	1,368	2,030	1,692	1,692	2,112	2,112
00380	3.80	75	43	1,140	1,140	1,200	1,368	2,030	1,692	1,692	2,112	2,112
00390	3.90	75	43	1,140	1,140	1,200	1,368	2,030	1,692	1,692	2,112	2,112
00400	4.00	75	43	1,072	1,072	1,128	1,286	1,915	1,596	1,596	1,992	1,992
00410	4.10	75	43	1,174	1,174	1,236	1,409	2,102	1,752	1,752	2,196	2,196
00420	4.20	75	43	1,174	1,174	1,236	1,409	2,102	1,752	1,752	2,196	2,196
00425	4.25	75	43	1,243	1,243	1,308	1,491	2,232	1,860	1,860	2,328	2,328
00430	4.30	80	47	1,243	1,243	1,308	1,491	2,232	1,860	1,860	2,328	2,328
00440	4.40	80	47	1,243	1,243	1,308	1,491	2,232	1,860	1,860	2,328	2,328
00450	4.50	80	47	1,208	1,208	1,272	1,450	2,160	1,800	1,800	2,256	2,256
00460	4.60	80	47	1,243	1,243	1,308	1,491	2,232	1,860	1,860	2,328	2,328
00470	4.70	80	47	1,243	1,243	1,308	1,491	2,232	1,860	1,860	2,328	2,328
00475	4.75	80	47	1,311	1,311	1,380	1,573	2,362	1,968	1,968	2,460	2,460
00480	4.80	86	52	1,311	1,311	1,380	1,573	2,362	1,968	1,968	2,460	2,460
00490	4.90	86	52	1,311	1,311	1,380	1,573	2,362	1,968	1,968	2,460	2,460
00500	5.00	86	52	1,311	1,311	1,380	1,573	2,362	1,968	1,968	2,460	2,460
00510	5.10	86	52	1,459	1,459	1,536	1,751	2,606	2,172	2,172	2,712	2,712
00520	5.20	86	52	1,459	1,459	1,536	1,751	2,606	2,172	2,172	2,712	2,712
00525	5.25	86	52	1,459	1,459	1,536	1,751	2,606	2,172	2,172	2,712	2,712
00530	5.30	86	52	1,459	1,459	1,536	1,751	2,606	2,172	2,172	2,712	2,712
00540	5.40	93	57	1,778	1,778	1,872	2,134	3,182	2,652	2,652	3,312	3,312
00550	5.50	93	57	1,778	1,778	1,872	2,134	3,182	2,652	2,652	3,312	3,312
00560	5.60	93	57	1,778	1,778	1,872	2,134	3,182	2,652	2,652	3,312	3,312
00570	5.70	93	57	1,778	1,778	1,872	2,134	3,182	2,652	2,652	3,312	3,312
00575	5.75	93	57	1,778	1,778	1,872	2,134	3,182	2,652	2,652	3,312	3,312
00580	5.80	93	57	1,778	1,778	1,872	2,134	3,182	2,652	2,652	3,312	3,312
00590	5.90	93	57	1,778	1,778	1,872	2,134	3,182	2,652	2,652	3,312	3,312
00600	6.00	93	57	1,778	1,778	1,872	2,134	3,182	2,652	2,652	3,312	3,312
00610	6.10	101	63	2,858	2,858	3,008	3,429	5,126	4,272	4,272	5,344	5,344
00620	6.20	101	63	2,858	2,858	3,008	3,429	5,126	4,272	4,272	5,344	5,344
00625	6.25	101	63	2,858	2,858	3,008	3,429	5,126	4,272	4,272	5,344	5,344
00630	6.30	101	63	2,858	2,858	3,008	3,429	5,126	4,272	4,272	5,344	5,344
00640	6.40	101	63	3,070	3,070	3,232	3,684	5,491	4,576	4,576	5,728	5,728
00650	6.50	101	63	3,070	3,070	3,232	3,684	5,491	4,576	4,576	5,728	5,728
00660	6.60	101	63	3,070	3,070	3,232	3,684	5,491	4,576	4,576	5,728	5,728
00670	6.70	101	63	3,070	3,070	3,232	3,684	5,491	4,576	4,576	5,728	5,728
00675	6.75	109	69	3,937	3,937	4,144	4,724	7,046	5,872	5,872	7,344	7,344
00680	6.80	109	69	3,937	3,937	4,144	4,724	7,046	5,872	5,872	7,344	7,344

*Posebno označene stavke (bold) odnose se na robu koju imamo na lageru. Za ostali asortiman rabate i rokove isporuke dajemo na osnovu upita.

*Items given in bold figures refer to products on stock. Discount and delivery terms for other product assortment are given at request.

*Die separat gekennzeichneten artikel (bold) beziehen sich auf die Ware, die auf Lager liegt. Die Rabatte und Lieferzeiten für das restliche Sortiment geben wir auf Anfrage bekannt.

Series	BV20 BV21 BV22 BV23 BV25 BV26 BV27 BV28 BV29											
	Material	HSS	HSS	HSS	HSS	Co 5%	Co 5%	Co 5%	Co 8%	Co 8%		
	Type	RN	RN	RN	RS	RS	RN	RN	RN	RN		
	Point angle	130°C	130°C	130°C	130°C	130°C	130°C	130°C	130°C	130°C		
	Execution	ground	ground	ground	ground	ground	ground	ground	ground	ground		
	Finish	black	black/b	b/g	bright	gold	gold	bright	gold	bright		
d		l ₁	l ₂	price EUR								
mm	mm	mm	each	each	each	each	each	each	each	each	each	
00690	6.90	109	69	3,937	3,937	4,144	4,724	7,046	5,872	5,872	7,344	7,344
00700	7.00	109	69	3,678	3,678	3,872	4,414	6,586	5,488	5,488	6,864	6,864
00710	7.10	109	69	3,982	3,982	4,192	4,779	7,123	5,936	5,936	7,424	7,424
00720	7.20	109	69	4,134	4,134	4,352	4,961	7,411	6,176	6,176	7,728	7,728
00725	7.25	109	69	4,134	4,134	4,352	4,961	7,411	6,176	6,176	7,728	7,728
00730	7.30	109	69	4,134	4,134	4,352	4,961	7,411	6,176	6,176	7,728	7,728
00740	7.40	109	69	4,134	4,134	4,352	4,961	7,411	6,176	6,176	7,728	7,728
00750	7.50	109	69	4,134	4,134	4,352	4,961	7,411	6,176	6,176	7,728	7,728
00760	7.60	117	75	4,438	4,438	4,672	5,326	7,949	6,624	6,624	8,288	8,288
00770	7.70	117	75	4,438	4,438	4,672	5,326	7,949	6,624	6,624	8,288	8,288
00775	7.75	117	75	4,438	4,438	4,672	5,326	7,949	6,624	6,624	8,288	8,288
00780	7.80	117	75	4,438	4,438	4,672	5,326	7,949	6,624	6,624	8,288	8,288
00790	7.90	117	75	4,438	4,438	4,672	5,326	7,949	6,624	6,624	8,288	8,288
00800	8.00	117	75	4,438	4,438	4,672	5,326	7,949	6,624	6,624	8,288	8,288
00810	8.10	117	75	4,742	4,742	4,992	5,691	8,506	7,088	7,088	8,864	8,864
00820	8.20	117	75	4,742	4,742	4,992	5,691	8,506	7,088	7,088	8,864	8,864
00825	8.25	117	75	4,742	4,742	4,992	5,691	8,506	7,088	7,088	8,864	8,864
00830	8.30	117	75	4,742	4,742	4,992	5,691	8,506	7,088	7,088	8,864	8,864
00840	8.40	117	75	4,742	4,742	4,992	5,691	8,506	7,088	7,088	8,864	8,864
00850	8.50	117	75	4,697	4,697	4,944	5,636	8,410	7,008	7,008	8,768	8,768
00860	8.60	125	81	5,776	5,776	6,080	6,931	10,330	8,608	8,608	10,768	10,768
00870	8.70	125	81	5,776	5,776	6,080	6,931	10,330	8,608	8,608	10,768	10,768
00875	8.75	125	81	5,776	5,776	6,080	6,931	10,330	8,608	8,608	10,768	10,768
00880	8.80	125	81	5,776	5,776	6,080	6,931	10,330	8,608	8,608	10,768	10,768
00890	8.90	125	81	5,776	5,776	6,080	6,931	10,330	8,608	8,608	10,768	10,768
00900	9.00	125	81	5,776	5,776	6,080	6,931	10,330	8,608	8,608	10,768	10,768
00910	9.10	125	81	5,822	5,822	6,128	6,986	10,426	8,688	8,688	10,864	10,864
00920	9.20	125	81	5,822	5,822	6,128	6,986	10,426	8,688	8,688	10,864	10,864
00925	9.25	125	81	6,232	6,232	6,560	7,478	11,155	9,296	9,296	11,616	11,616
00930	9.30	125	81	6,232	6,232	6,560	7,478	11,155	9,296	9,296	11,616	11,616
00940	9.40	125	81	6,232	6,232	6,560	7,478	11,155	9,296	9,296	11,616	11,616
00950	9.50	125	81	6,232	6,232	6,560	7,478	11,155	9,296	9,296	11,616	11,616
00960	9.60	133	87	6,642	6,642	6,992	7,971	11,885	9,904	9,904	12,384	12,384
00970	9.70	133	87	6,642	6,642	6,992	7,971	11,885	9,904	9,904	12,384	12,384
00975	9.75	133	87	6,840	6,840	7,200	8,208	12,250	10,208	10,208	12,768	12,768
00980	9.80	133	87	6,840	6,840	7,200	8,208	12,250	10,208	10,208	12,768	12,768
00990	9.90	133	87	6,840	6,840	7,200	8,208	12,250	10,208	10,208	12,768	12,768
01000	10.00	133	87	6,840	6,840	7,200	8,208	12,250	10,208	10,208	12,768	12,768
01010	10.10	133	87	7,554	7,554	7,952	9,065	13,517	11,264	11,264	14,080	14,080
01020	10.20	133	87	7,554	7,554	7,952	9,065	13,517	11,264	11,264	14,080	14,080
01025	10.25	133	87	8,573	8,573	9,024	10,287	15,360	12,800	12,800	16,000	16,000
01030	10.30	133	87	8,573	8,573	9,024	10,287	15,360	12,800	12,800	16,000	16,000
01040	10.40	133	87	8,573	8,573	9,024	10,287	15,360	12,800	12,800	16,000	16,000
01050	10.50	133	87	8,573	8,573	9,024	10,287	15,360	12,800	12,800	16,000	16,000
01060	10.60	142	94	9,394	9,394	9,888	11,272	16,819	14,016	14,016	17,520	17,520
01070	10.70	142	94	9,394	9,394	9,888	11,272	16,819	14,016	14,016	17,520	17,520
01075	10.75	142	94	10,062	10,062	10,592	12,075	18,010	15,008	15,008	18,768	18,768
01080	10.80	142	94	10,062	10,062	10,592	12,075	18,010	15,008	15,008	18,768	18,768
01090	10.90	142	94	10,062	10,062	10,592	12,075	18,010	15,008	15,008	18,768	18,768
01100	11.00	142	94	10,062	10,062	10,592	12,075	18,010	15,008	15,008	18,768	18,768
01110	11.10	142	94	10,321	10,321	10,864	12,385	18,470	15,392	15,392	19,248	19,248

Series	BV20		BV21		BV22		BV23		BV25		BV26		BV27		BV28		BV29		
	Material	HSS	HSS	HSS	HSS	Co 5%	Co 5%	Co 5%	Co 8%	Co 8%	Co 5%	Co 5%	Co 8%	Co 8%	Co 5%	Co 5%	Co 8%	Co 8%	
Type	RN	RN	RN	RS	RS	RN	RN	RN	RN	RN	RN	RN	RN	RN	RN	RN	RN	RN	
Point angle	130°/C	130°/C	130°/C	130°/C	130°/C	130°/C	130°/C	130°/C	130°/C	130°/C	130°/C	130°/C	130°/C	130°/C	130°/C	130°/C	130°/C	130°/C	
Execution	ground	ground	ground	ground	ground	ground	ground	ground	ground	ground	ground	ground	ground	ground	ground	ground	ground	ground	
Finish	black	black/b	b/g	bright	gold	gold	gold	bright	gold	gold	bright	gold	gold	bright	gold	gold	bright	bright	
d		l ₁		l ₂		price EUR													
mm		mm		mm		each	each	each	each	each	each	each	each	each	each	each	each	each	each
01120	11.20	142	94	10,321	10,321	10,864	12,385	18,470	15,392	15,392	19,248	19,248							
01125	11.25	142	94	10,518	10,518	11,072	12,622	18,835	15,696	15,696	19,616	19,616							
01130	11.30	142	94	10,518	10,518	11,072	12,622	18,835	15,696	15,696	19,616	19,616							
01140	11.40	142	94	10,518	10,518	11,072	12,622	18,835	15,696	15,696	19,616	19,616							
01150	11.50	142	94	10,518	10,518	11,072	12,622	18,835	15,696	15,696	19,616	19,616							
01160	11.60	142	94	11,081	11,081	11,664	13,297	19,834	16,528	16,528	20,656	20,656							
01170	11.70	142	94	11,081	11,081	11,664	13,297	19,834	16,528	16,528	20,656	20,656							
01175	11.75	142	94	11,643	11,643	12,256	13,972	20,832	17,360	17,360	21,696	21,696							
01180	11.80	142	94	11,643	11,643	12,256	13,972	20,832	17,360	17,360	21,696	21,696							
01190	11.90	151	101	11,643	11,643	12,256	13,972	20,832	17,360	17,360	21,696	21,696							
01200	12.00	151	101	11,643	11,643	12,256	13,972	20,832	17,360	17,360	21,696	21,696							
01210	12.10	151	101	12,206	12,206	12,848	14,647	21,850	18,208	18,208	22,768	22,768							
01220	12.20	151	101	12,206	12,206	12,848	14,647	21,850	18,208	18,208	22,768	22,768							
01225	12.25	151	101	12,722	12,722	13,392	15,267	22,752	18,960	18,960	23,696	23,696							
01230	12.30	151	101	12,722	12,722	13,392	15,267	22,752	18,960	18,960	23,696	23,696							
01240	12.40	151	101	12,722	12,722	13,392	15,267	22,752	18,960	18,960	23,696	23,696							
01250	12.50	151	101	12,722	12,722	13,392	15,267	22,752	18,960	18,960	23,696	23,696							
01260	12.60	151	101	12,874	12,874	13,552	15,449	23,040	19,200	19,200	24,000	24,000							
01270	12.70	151	101	12,874	12,874	13,552	15,449	23,040	19,200	19,200	24,000	24,000							
01275	12.75	151	101	12,966	12,966	13,648	15,559	23,213	19,344	19,344	24,176	24,176							
01280	12.80	151	101	12,966	12,966	13,648	15,559	23,213	19,344	19,344	24,176	24,176							
01290	12.90	151	101	12,966	12,966	13,648	15,559	23,213	19,344	19,344	24,176	24,176							
01300	13.00	151	101	12,966	12,966	13,648	15,559	23,213	19,344	19,344	24,176	24,176							
01325	13.25	160	108	18,964	18,964	19,962	22,757	33,934	28,278	28,278	30,492	30,492							
01350	13.50	160	108	18,964	18,964	19,962	22,757	33,934	28,278	28,278	30,492	30,492							
01375	13.75	160	108	18,964	18,964	19,962	22,757	33,934	28,278	28,278	30,492	30,492							
01400	14.00	160	108	18,964	18,964	19,962	22,757	33,934	28,278	28,278	30,492	30,492							
01425	14.25	169	114	22,008	22,008	23,166	26,409	39,377	32,814	32,814	41,022	41,022							
01450	14.50	169	114	22,008	22,008	23,166	26,409	39,377	32,814	32,814	41,022	41,022							
01475	14.75	169	114	22,008	22,008	23,166	26,409	39,377	32,814	32,814	41,022	41,022							
01500	15.00	169	114	22,008	22,008	23,166	26,409	39,377	32,814	32,814	41,022	41,022							
01525	15.25	178	120	25,855	25,855	27,216	31,026	52,747	43,956	43,956	54,954	54,954							
01550	15.50	178	120	25,855	25,855	27,216	31,026	52,747	43,956	43,956	54,954	54,954							
01575	15.75	178	120	27,582	27,582	29,034	33,099	49,356	41,130	41,130	51,408	51,408							
01600	16.00	178	120	27,582	27,582	29,034	33,099	49,356	41,130	41,130	51,408	51,408							
01625	16.25	184	125	30,164	30,164	31,752	36,197	53,978	44,982	44,982	56,232	56,232							
01650	16.50	184	125	30,164	30,164	31,752	36,197	53,978	44,982	44,982	56,232	56,232							
01675	16.75	184	125	30,164	30,164	31,752	36,197	53,978	44,982	44,982	56,232	56,232							
01700	17.00	184	125	30,164	30,164	31,752	36,197	53,978	44,982	44,982	56,232	56,232							
01725	17.25	191	130	34,063	34,063	35,856	40,876	60,977	50,814	50,814	63,522	63,522							
01750	17.50	191	130	34,063	34,063	35,856	40,876	60,977	50,814	50,814	63,522	63,522							
01775	17.75	191	130	34,063	34,063	35,856	40,876	60,977	50,814	50,814	63,522	63,522							
01800	18.00	191	130	34,063	34,063	35,856	40,876	60,977	50,814	50,814	63,522	63,522							
01825	18.25	198	135	39,638	39,638	41,724	47,565	70,934	59,112	59,112	73,890	73,890							
01850	18.50	198	135	39,638	39,638	41,724	47,565	70,934	59,112	59,112	73,890	73,890							
01875	18.75	198	135	39,638	39,638	41,724	47,565	70,934	59,112	59,112	73,890	73,890							
01900	19.00	198	135	39,638	39,638	41,724	47,565	70,934	59,112	59,112	73,890	73,890							
01925	19.25	205	140	43,092	43,092	45,360	51,710	77,112	64,260	64,260	80,334	80,334							
01950	19.50	205	140	43,092	43,092	45,360	51,710	77,112	64,260	64,260	80,334	80,334							
01975	19.75	205	140	43,092	43,092	45,360	51,710	77,112	64,260	64,260	80,334	80,334							
02000	20.00	205	140	43,092	43,092	45,360	51,710	77,112	64,260	64,260	80,334	80,334							

*Posebno označene stavke (**bold**) odnose se na robu koju imamo na lageru. Za ostali asortiman rabate i rokove isporuke dajemo na osnovu upita.

*Items given in **bold** figures refer to products on stock. Discount and delivery terms for other product assortment are given at request.

*Die separat gekennzeichneten artikel (**bold**) beziehen sich auf die Ware, die auf Lager liegt. Die Rabatte und Lieferzeiten für das restliche Sortiment geben wir auf Anfrage bekannt.

SPIRALNE BURGJE VALJKASTE, KRATKE

TWIST DRILLS STRAIGHT SHANK, JOBBER LENGTH

SPIRALBOHRER ZYLINDERSCHAFT, KURZE

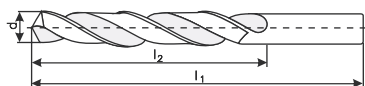

Series				BV20S	BV21S	BV26S	BV27S	BV28S	BV29S
	Material	Type	Point angle	Spiral angle	Execution	Finish	price EUR		
	d	l ₁	l ₂						
	mm	mm	mm	each	each	each	each	each	each
00030	0,30	19	3	2,032	2,031	3,036	3,036	3,802	3,802
00040	0,40	20	5	1,643	1,643	2,455	2,455	3,076	3,076
00050	0,50	22	6	1,329	1,329	1,980	1,980	2,482	2,482
00055	0,55	24	7	1,530	1,530	2,270	2,270	2,838	2,838
00060	0,60	24	7	1,404	1,404	2,099	2,099	2,627	2,627
00065	0,65	26	8	1,492	1,492	2,218	2,218	2,772	2,772
00070	0,70	28	9	1,492	1,492	2,218	2,218	2,772	2,772
00075	0,75	28	9	1,404	1,404	2,099	2,099	2,627	2,627
00080	0,80	30	10	1,292	1,292	1,927	1,927	2,416	2,416
00085	0,85	30	10	1,292	1,292	1,927	1,927	2,416	2,416
00090	0,90	32	11	1,292	1,292	1,927	1,927	2,416	2,416
00095	0,95	32	11	1,292	1,292	1,927	1,927	2,416	2,416
00100	1,00	34	12	1,091	1,091	1,637	1,637	2,046	2,046
00110	1,10	36	14	1,016	1,016	1,518	1,518	1,901	1,901
00120	1,20	38	14	1,179	1,179	1,756	1,756	2,191	2,191
00125	1,25	38	14	1,091	1,091	1,637	1,637	2,046	2,046
00130	1,30	38	14	1,016	1,016	1,518	1,518	1,901	1,901
00140	1,40	40	18	0,978	0,978	1,465	1,465	1,835	1,835
00150	1,50	40	18	0,865	0,865	1,280	1,280	1,597	1,597
00160	1,60	43	20	0,903	0,903	1,346	1,346	1,690	1,690
00170	1,70	43	20	0,978	0,978	1,465	1,465	1,835	1,835
00175	1,75	46	22	0,978	0,978	1,465	1,465	1,835	1,835
00180	1,80	46	22	0,865	0,865	1,280	1,280	1,597	1,597
00190	1,90	46	22	0,865	0,865	1,280	1,280	1,597	1,597
00200	2,00	49	24	0,777	0,777	1,162	1,162	1,452	1,452
00210	2,10	49	24	0,777	0,777	1,162	1,162	1,452	1,452
00220	2,20	53	27	0,777	0,777	1,162	1,162	1,452	1,452
00225	2,25	53	27	0,865	0,865	1,280	1,280	1,597	1,597
00230	2,30	53	27	0,777	0,777	1,162	1,162	1,452	1,452
00240	2,40	57	30	0,865	0,865	1,280	1,280	1,597	1,597

*Posebno označene stavke (**bold**) odnose se na robu koju imamo na lageru. Za ostali asortiman rabate i rokove isporuke dajemo na osnovu upita.

*Items given in **bold** figures refer to products on stock. Discount and delivery terms for other product assortment are given at request.

*Die separat gekennzeichneten artikel (**bold**) beziehen sich auf die Ware, die auf Lager liegt. Die Rabatte und Lieferzeiten für das restliche Sortiment geben wir auf Anfrage bekannt.

Series				BV20S	BV21S	BV26S	BV27S	BV28S	BV29S
	Material				HSS	HSS	Co 5%	Co 5%	Co 8%
Type				MS	MS	MS	MS	MS	MS
Point angle				130°/C	130°/C	130°/C	130°/C	130°/C	130°/C
Spiral angle				35°	35°	35°	35°	35°	35°
Execution				ground	ground	ground	ground	ground	ground
Finish				black	black/b	gold	bright	gold	bright
	d	l ₁	l ₂	price EUR					
	mm	mm	mm	each	each	each	each	each	each
00250	2,50	57	30	0,865	0,865	1,280	1,280	1,597	1,597
00260	2,60	57	30	0,865	0,865	1,280	1,280	1,597	1,597
00270	2,70	61	33	0,865	0,865	1,280	1,280	1,597	1,597
00275	2,75	61	33	0,865	0,865	1,280	1,280	1,597	1,597
00280	2,80	61	33	0,865	0,865	1,280	1,280	1,597	1,597
00290	2,90	61	33	0,865	0,865	1,280	1,280	1,597	1,597
00300	3,00	61	33	0,865	0,865	1,280	1,280	1,597	1,597
00310	3,10	65	36	0,865	0,865	1,280	1,280	1,597	1,597
00320	3,20	65	36	0,865	0,865	1,280	1,280	1,597	1,597
00325	3,25	65	36	1,016	1,016	1,518	1,518	1,901	1,901
00330	3,30	65	36	1,016	1,016	1,518	1,518	1,901	1,901
00340	3,40	70	39	1,053	1,053	1,571	1,571	1,967	1,967
00350	3,50	70	39	1,053	1,053	1,571	1,571	1,967	1,967
00360	3,60	70	39	1,091	1,091	1,637	1,637	2,046	2,046
00370	3,70	70	39	1,091	1,091	1,637	1,637	2,046	2,046
00375	3,75	70	39	1,254	1,254	1,861	1,861	2,323	2,323
00380	3,80	75	43	1,254	1,254	1,861	1,861	2,323	2,323
00390	3,90	75	43	1,254	1,254	1,861	1,861	2,323	2,323
00400	4,00	75	43	1,179	1,179	1,756	1,756	2,191	2,191
00410	4,10	75	43	1,292	1,292	1,927	1,927	2,416	2,416
00420	4,20	75	43	1,292	1,292	1,927	1,927	2,416	2,416
00425	4,25	75	43	1,367	1,367	2,046	2,046	2,561	2,561
00430	4,30	80	47	1,367	1,367	2,046	2,046	2,561	2,561
00440	4,40	80	47	1,367	1,367	2,046	2,046	2,561	2,561
00450	4,50	80	47	1,329	1,329	1,980	1,980	2,482	2,482
00460	4,60	80	47	1,367	1,367	2,046	2,046	2,561	2,561
00470	4,70	80	47	1,367	1,367	2,046	2,046	2,561	2,561
00475	4,75	80	47	1,442	1,442	2,165	2,165	2,706	2,706
00480	4,80	86	52	1,442	1,442	2,165	2,165	2,706	2,706
00490	4,90	86	52	1,442	1,442	2,165	2,165	2,706	2,706
00500	5,00	86	52	1,442	1,442	2,165	2,165	2,706	2,706
00510	5,10	86	52	1,605	1,605	2,389	2,389	2,983	2,983
00520	5,20	86	52	1,605	1,605	2,389	2,389	2,983	2,983
00525	5,25	86	52	1,605	1,605	2,389	2,389	2,983	2,983
00530	5,30	86	52	1,605	1,605	2,389	2,389	2,983	2,983
00540	5,40	93	57	1,956	1,956	2,917	2,917	3,643	3,643
00550	5,50	93	57	1,956	1,956	2,917	2,917	3,643	3,643
00560	5,60	93	57	1,956	1,956	2,917	2,917	3,643	3,643
00570	5,70	93	57	1,956	1,956	2,917	2,917	3,643	3,643
00575	5,75	93	57	1,956	1,956	2,917	2,917	3,643	3,643
00580	5,80	93	57	1,956	1,956	2,917	2,917	3,643	3,643
00590	5,90	93	57	1,956	1,956	2,917	2,917	3,643	3,643
00600	6,00	93	57	1,956	1,956	2,917	2,917	3,643	3,643
00610	6,10	101	63	3,143	3,143	4,699	4,699	5,878	5,878
00620	6,20	101	63	3,143	3,143	4,699	4,699	5,878	5,878
00625	6,25	101	63	3,143	3,143	4,699	4,699	5,878	5,878
00630	6,30	101	63	3,143	3,143	4,699	4,699	5,878	5,878
00640	6,40	101	63	3,377	3,377	5,034	5,034	6,301	6,301
00650	6,50	101	63	3,377	3,377	5,034	5,034	6,301	6,301
00660	6,60	101	63	3,377	3,377	5,034	5,034	6,301	6,301
00670	6,70	101	63	3,377	3,377	5,034	5,034	6,301	6,301
00675	6,75	109	69	4,330	4,330	6,459	6,459	8,078	8,078
00680	6,80	109	69	4,330	4,330	6,459	6,459	8,078	8,078

*Posebno označene stavke (**bold**) odnose se na robu koju imamo na lageru. Za ostali asortiman rabate i rokove isporuke dajemo na osnovu upita.

*Items given in **bold** figures refer to products on stock. Discount and delivery terms for other product assortment are given at request.

*Die separat gekennzeichneten artikel (**bold**) beziehen sich auf die Ware, die auf Lager liegt. Die Rabatte und Lieferzeiten für das restliche Sortiment geben wir auf Anfrage bekannt.

Series				BV20S	BV21S	BV26S	BV27S	BV28S	BV29S
	Material				HSS	HSS	Co 5%	Co 5%	Co 8%
Type				MS	MS	MS	MS	MS	MS
Point angle				130°/C	130°/C	130°/C	130°/C	130°/C	130°/C
Spiral angle				35°	35°	35°	35°	35°	35°
Execution				ground	ground	ground	ground	ground	ground
Finish				black	black/b	gold	bright	gold	bright
				price EUR					
				each	each	each	each	each	each
	d	l ₁	l ₂						
	mm	mm	mm						
00690	6,90	109	69	4,330	4,330	6,459	6,459	8,078	8,078
00700	7,00	109	69	4,046	4,046	6,037	6,037	7,550	7,550
00710	7,10	109	69	4,381	4,381	6,530	6,530	8,166	8,166
00720	7,20	109	69	4,548	4,548	6,794	6,794	8,501	8,501
00725	7,25	109	69	4,548	4,548	6,794	6,794	8,501	8,501
00730	7,30	109	69	4,548	4,548	6,794	6,794	8,501	8,501
00740	7,40	109	69	4,548	4,548	6,794	6,794	8,501	8,501
00750	7,50	109	69	4,548	4,548	6,794	6,794	8,501	8,501
00760	7,60	117	75	4,882	4,882	7,286	7,286	9,117	9,117
00770	7,70	117	75	4,882	4,882	7,286	7,286	9,117	9,117
00775	7,75	117	75	4,882	4,882	7,286	7,286	9,117	9,117
00780	7,80	117	75	4,882	4,882	7,286	7,286	9,117	9,117
00790	7,90	117	75	4,882	4,882	7,286	7,286	9,117	9,117
00800	8,00	117	75	4,882	4,882	7,286	7,286	9,117	9,117
00810	8,10	117	75	5,217	5,217	7,797	7,797	9,750	9,750
00820	8,20	117	75	5,217	5,217	7,797	7,797	9,750	9,750
00825	8,25	117	75	5,217	5,217	7,797	7,797	9,750	9,750
00830	8,30	117	75	5,217	5,217	7,797	7,797	9,750	9,750
00840	8,40	117	75	5,217	5,217	7,797	7,797	9,750	9,750
00850	8,50	117	75	5,166	5,166	7,709	7,709	9,645	9,645
00860	8,60	125	81	6,354	6,354	9,469	9,469	11,845	11,845
00870	8,70	125	81	6,354	6,354	9,469	9,469	11,845	11,845
00875	8,75	125	81	6,354	6,354	9,469	9,469	11,845	11,845
00880	8,80	125	81	6,354	6,354	9,469	9,469	11,845	11,845
00890	8,90	125	81	6,354	6,354	9,469	9,469	11,845	11,845
00900	9,00	125	81	6,354	6,354	9,469	9,469	11,845	11,845
00910	9,10	125	81	6,404	6,404	9,557	9,557	11,950	11,950
00920	9,20	125	81	6,404	6,404	9,557	9,557	11,950	11,950
00925	9,25	125	81	6,855	6,855	10,226	10,226	12,778	12,778
00930	9,30	125	81	6,855	6,855	10,226	10,226	12,778	12,778
00940	9,40	125	81	6,855	6,855	10,226	10,226	12,778	12,778
00950	9,50	125	81	6,855	6,855	10,226	10,226	12,778	12,778
00960	9,60	133	87	7,307	7,307	10,894	10,894	13,622	13,622
00970	9,70	133	87	7,307	7,307	10,894	10,894	13,622	13,622
00975	9,75	133	87	7,524	7,524	11,229	11,229	14,045	14,045
00980	9,80	133	87	7,524	7,524	11,229	11,229	14,045	14,045
00990	9,90	133	87	7,524	7,524	11,229	11,229	14,045	14,045
01000	10,00	133	87	7,524	7,524	11,229	11,229	14,045	14,045
01010	10,10	133	87	8,310	8,310	12,390	12,390	15,488	15,488
01020	10,20	133	87	8,310	8,310	12,390	12,390	15,488	15,488
01025	10,25	133	87	9,430	9,430	14,080	14,080	17,600	17,600
01030	10,30	133	87	9,430	9,430	14,080	14,080	17,600	17,600
01040	10,40	133	87	9,430	9,430	14,080	14,080	17,600	17,600
01050	10,50	133	87	9,430	9,430	14,080	14,080	17,600	17,600
01060	10,60	142	94	10,333	10,333	15,418	15,418	19,272	19,272
01070	10,70	142	94	10,333	10,333	15,418	15,418	19,272	19,272
01075	10,75	142	94	11,069	11,069	16,509	16,509	20,645	20,645
01080	10,80	142	94	11,069	11,069	16,509	16,509	20,645	20,645
01090	10,90	142	94	11,069	11,069	16,509	16,509	20,645	20,645
01100	11,00	142	94	11,069	11,069	16,509	16,509	20,645	20,645
01110	11,10	142	94	11,353	11,353	16,931	16,931	21,173	21,173

*Posebno označene stavke (**bold**) odnose se na robu koju imamo na lageru. Za ostali asortiman rabate i rokove isporuke dajemo na osnovu upita.

*Items given in **bold** figures refer to products on stock. Discount and delivery terms for other product assortment are given at request.

*Die separat gekennzeichneten artikel (**bold**) beziehen sich auf die Ware, die auf Lager liegt. Die Rabatte und Lieferzeiten für das restliche Sortiment geben wir auf Anfrage bekannt.

Series				BV20S	BV21S	BV26S	BV27S	BV28S	BV29S
	Material			HSS	HSS	Co 5%	Co 5%	Co 8%	Co 8%
	Type			MS	MS	MS	MS	MS	MS
	Point angle			130°/C	130°/C	130°/C	130°/C	130°/C	130°/C
	Spiral angle			35°	35°	35°	35°	35°	35°
	Execution			ground	ground	ground	ground	ground	ground
	Finish			black	black/b	gold	bright	gold	bright
			price EUR						
	d	l ₁	l ₂	each		each		each	
	mm	mm	mm	each	each	each	each	each	each
01120	11,20	142	94	11,353	11,353	16,931	16,931	21,173	21,173
01125	11,25	142	94	11,570	11,570	17,266	17,266	21,578	21,578
01130	11,30	142	94	11,570	11,570	17,266	17,266	21,578	21,578
01140	11,40	142	94	11,570	11,570	17,266	17,266	21,578	21,578
01150	11,50	142	94	11,570	11,570	17,266	17,266	21,578	21,578
01160	11,60	142	94	12,189	12,189	18,181	18,181	22,722	22,722
01170	11,70	142	94	12,189	12,189	18,181	18,181	22,722	22,722
01175	11,75	142	94	12,808	12,808	19,096	19,096	23,866	23,866
01180	11,80	142	94	12,808	12,808	19,096	19,096	23,866	23,866
01190	11,90	151	101	12,808	12,808	19,096	19,096	23,866	23,866
01200	12,00	151	101	12,808	12,808	19,096	19,096	23,866	23,866
01210	12,10	151	101	13,426	13,426	20,029	20,029	25,045	25,045
01220	12,20	151	101	13,426	13,426	20,029	20,029	25,045	25,045
01225	12,25	151	101	13,995	13,995	20,856	20,856	26,066	26,066
01230	12,30	151	101	13,995	13,995	20,856	20,856	26,066	26,066
01240	12,40	151	101	13,995	13,995	20,856	20,856	26,066	26,066
01250	12,50	151	101	13,995	13,995	20,856	20,856	26,066	26,066
01260	12,60	151	101	14,162	14,162	21,120	21,120	26,400	26,400
01270	12,70	151	101	14,162	14,162	21,120	21,120	26,400	26,400
01275	12,75	151	101	14,262	14,262	21,278	21,278	26,594	26,594
01280	12,80	151	101	14,262	14,262	21,278	21,278	26,594	26,594
01290	12,90	151	101	14,262	14,262	21,278	21,278	26,594	26,594
01300	13,00	151	101	14,262	14,262	21,278	21,278	26,594	26,594
01325	13,25	160	108	20,860	20,860	31,106	31,106	33,541	33,541
01350	13,50	160	108	20,860	20,860	31,106	31,106	33,541	33,541
01375	13,75	160	108	20,860	20,860	31,106	31,106	33,541	33,541
01400	14,00	160	108	20,860	20,860	31,106	31,106	33,541	33,541
01425	14,25	169	114	24,208	24,208	36,095	36,095	45,124	45,124
01450	14,50	169	114	24,208	24,208	36,095	36,095	45,124	45,124
01475	14,75	169	114	24,208	24,208	36,095	36,095	45,124	45,124
01500	15,00	169	114	24,208	24,208	36,095	36,095	45,124	45,124
01525	15,25	178	120	28,441	28,441	48,352	48,352	60,449	60,449
01550	15,50	178	120	28,441	28,441	48,352	48,352	60,449	60,449
01575	15,75	178	120	30,341	30,341	45,243	45,243	56,549	56,549
01600	16,00	178	120	30,341	30,341	45,243	45,243	56,549	56,549
01625	16,25	184	125	33,181	33,181	49,480	49,480	61,855	61,855
01650	16,50	184	125	33,181	33,181	49,480	49,480	61,855	61,855
01675	16,75	184	125	33,181	33,181	49,480	49,480	61,855	61,855
01700	17,00	184	125	33,181	33,181	49,480	49,480	61,855	61,855
01725	17,25	191	130	37,470	37,470	55,895	55,895	69,874	69,874
01750	17,50	191	130	37,470	37,470	55,895	55,895	69,874	69,874
01775	17,75	191	130	37,470	37,470	55,895	55,895	69,874	69,874
01800	18,00	191	130	37,470	37,470	55,895	55,895	69,874	69,874
01825	18,25	198	135	43,602	43,602	65,023	65,023	81,279	81,279
01850	18,50	198	135	43,602	43,602	65,023	65,023	81,279	81,279
01875	18,75	198	135	43,602	43,602	65,023	65,023	81,279	81,279
01900	19,00	198	135	43,602	43,602	65,023	65,023	81,279	81,279
01925	19,25	205	140	47,401	47,401	70,686	70,686	88,367	88,367
01950	19,50	205	140	47,401	47,401	70,686	70,686	88,367	88,367
01975	19,75	205	140	47,401	47,401	70,686	70,686	88,367	88,367
02000	20,00	205	140	47,401	47,401	70,686	70,686	88,367	88,367

*Posebno označene stavke (**bold**) odnose se na robu koju imamo na lageru. Za ostali asortiman rabate i rokove isporuke dajemo na osnovu upita.

*Items given in **bold** figures refer to products on stock. Discount and delivery terms for other product assortment are given at request.

*Die separat gekennzeichneten artikel (**bold**) beziehen sich auf die Ware, die auf Lager liegt. Die Rabatte und Lieferzeiten für das restliche Sortiment geben wir auf Anfrage bekannt.

SPIRALNE BURGIJE VALJKASTE,
DUGE

TWIST DRILLS STRAIGHT SHANK,
LONG SERIES

SPIRALBOHRER ZYLINDERSCHAFT,
LANGE

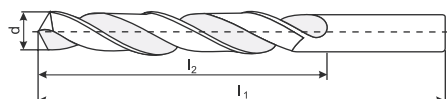

Series	BV31	BV32	BV33	BV34	BV35	BV36			
Material	HSS	HSS	HSS	Co 5%	HSS	Co 5%			
Type	RN	RN	RN	RN	RN	RS			
Point angle	118°	118°	118°	130°/C	130°/C	130°/C			
Execution	rolled	ground	ground	ground	ground	ground			
Finish	black	black	bright	bright	black	gold			
	d	l ₁	l ₂	price EUR					
	mm	mm	mm	each	each	each	each	each	
00100	1.00	56	33	1,956	2,736	2,736	4,104	3,010	4,925
00110	1.10	60	37	2,064	2,880	2,880	4,320	3,168	5,184
00120	1.20	65	41	1,800	2,508	2,508	3,768	2,759	4,522
00125	1.25	65	41	2,460	3,432	3,432	5,160	3,775	6,192
00130	1.30	65	41	1,800	2,508	2,508	3,768	2,759	4,522
00140	1.40	70	45	1,692	2,364	2,364	3,552	2,600	4,262
00150	1.50	70	45	1,428	1,992	1,992	2,988	2,191	3,586
00160	1.60	76	50	1,560	2,184	2,184	3,276	2,402	3,931
00170	1.70	76	50	1,500	2,112	2,112	3,156	2,323	3,787
00175	1.75	80	53	1,896	2,664	2,664	3,996	2,930	4,795
00180	1.80	80	53	1,500	2,112	2,112	3,156	2,323	3,787
00190	1.90	80	53	1,500	2,112	2,112	3,156	2,323	3,787
00200	2.00	85	56	1,188	1,668	1,668	2,496	1,835	2,995
00210	2.10	85	56	1,188	1,668	1,668	2,496	1,835	2,995
00220	2.20	90	59	1,164	1,632	1,632	2,436	1,795	2,923
00225	2.25	90	59	1,800	2,508	2,508	3,768	2,759	4,522
00230	2.30	90	59	1,164	1,632	1,632	2,436	1,795	2,923
00240	2.40	95	62	1,164	1,632	1,632	2,436	1,795	2,923
00250	2.50	95	62	1,164	1,632	1,632	2,436	1,795	2,923
00260	2.60	95	62	1,236	1,740	1,740	2,604	1,914	3,125
00270	2.70	100	66	1,236	1,740	1,740	2,604	1,914	3,125
00275	2.75	100	66	1,872	2,628	2,628	3,936	2,891	4,723
00280	2.80	100	66	1,320	1,848	1,848	2,772	2,033	3,326
00290	2.90	100	66	1,428	1,992	1,992	2,988	2,191	3,586
00300	3.00	100	66	1,164	1,632	1,632	2,436	1,795	2,923
00310	3.10	106	69	1,296	1,812	1,812	2,712	1,993	3,254
00320	3.20	106	69	1,164	1,632	1,632	2,436	1,795	2,923
00325	3.25	106	69	1,824	2,556	2,556	3,828	2,812	4,594
00330	3.30	106	69	1,164	1,632	1,632	2,436	1,795	2,923
00340	3.40	112	73	1,368	1,920	1,920	2,880	2,112	3,456
00350	3.50	112	73	1,368	1,920	1,920	2,880	2,112	3,456
00360	3.60	112	73	1,368	1,920	1,920	2,880	2,112	3,456

*Posebno označene stavke (**bold**) odnose se na robu koju imamo na lageru. Za ostali asortiman rabate i rokove isporuke dajemo na osnovu upita.

*Items given in **bold** figures refer to products on stock. Discount and delivery terms for other product assortment are given at request.

*Die separat gekennzeichneten artikel (**bold**) beziehen sich auf die Ware, die auf Lager liegt. Die Rabatte und Lieferzeiten für das restliche Sortiment geben wir auf Anfrage bekannt.

Series				BV31	BV32	BV33	BV34	BV35	BV36
	Material			HSS	HSS	HSS	Co 5%	HSS	Co 5%
	Type			RN	RN	RN	RN	RN	RS
	Point angle			118°	118°	118°	130°/C	130°/C	130°/C
	Execution			rolled	ground	ground	ground	ground	ground
	Finish			black	black	bright	bright	black	bright
	d	l ₁	l ₂	price EUR					
	mm	mm	mm	each	each	each	each	each	each
00370	3.70	112	73	1,428	1,992	1,992	2,988	2,191	3,586
00375	3.75	112	73	2,112	2,952	2,952	4,440	3,247	5,328
00380	3.80	119	78	1,452	2,028	2,028	3,048	2,231	3,658
00390	3.90	119	78	1,500	2,112	2,112	3,156	2,323	3,787
00400	4.00	119	78	1,500	2,112	2,112	3,156	2,323	3,787
00410	4.10	119	78	1,560	2,184	2,184	3,276	2,402	3,931
00420	4.20	119	78	1,560	2,184	2,184	3,276	2,402	3,931
00425	4.25	119	78	2,664	3,732	3,732	5,604	4,105	6,725
00430	4.30	126	82	1,800	2,508	2,508	3,768	2,759	4,522
00440	4.40	126	82	1,800	2,508	2,508	3,768	2,759	4,522
00450	4.50	126	82	1,800	2,508	2,508	3,768	2,759	4,522
00460	4.60	126	82	1,800	2,508	2,508	3,768	2,759	4,522
00470	4.70	126	82	1,800	2,508	2,508	3,768	2,759	4,522
00475	4.75	126	82	2,904	4,068	4,068	6,096	4,475	7,315
00480	4.80	132	87	1,896	2,664	2,664	3,996	2,930	4,795
00490	4.90	132	87	1,896	2,664	2,664	3,996	2,930	4,795
00500	5.00	132	87	1,896	2,664	2,664	3,996	2,930	4,795
00510	5.10	132	87	2,064	2,880	2,880	4,320	3,168	5,184
00520	5.20	132	87	2,064	2,880	2,880	4,320	3,168	5,184
00525	5.25	132	87	3,384	4,728	4,728	7,092	5,201	8,510
00530	5.30	132	87	2,064	2,880	2,880	4,320	3,168	5,184
00540	5.40	139	91	2,292	3,216	3,216	4,824	3,538	5,789
00550	5.50	139	91	2,292	3,216	3,216	4,824	3,538	5,789
00560	5.60	139	91	2,292	3,216	3,216	4,824	3,538	5,789
00570	5.70	139	91	2,292	3,216	3,216	4,824	3,538	5,789
00575	5.75	139	91	3,648	5,100	5,100	7,656	5,610	9,187
00580	5.80	139	91	2,292	3,216	3,216	4,824	3,538	5,789
00590	5.90	139	91	2,292	3,216	3,216	4,824	3,538	5,789
00600	6.00	148	97	2,292	3,216	3,216	4,824	3,538	5,789
00610	6.10	148	97	2,748	3,840	3,840	5,760	4,224	6,912
00620	6.20	148	97	2,748	3,840	3,840	5,760	4,224	6,912
00625	6.25	148	97	4,008	5,616	5,616	8,424	6,178	10,109
00630	6.30	148	97	2,748	3,840	3,840	5,760	4,224	6,912
00640	6.40	148	97	2,904	4,068	4,068	6,096	4,475	7,315
00650	6.50	148	97	2,904	4,068	4,068	6,096	4,475	7,315
00660	6.60	148	97	2,904	4,068	4,068	6,096	4,475	7,315
00670	6.70	148	97	2,904	4,068	4,068	6,096	4,475	7,315
00675	6.75	156	102	4,092	5,724	5,724	8,592	6,296	10,310
00680	6.80	156	102	3,384	4,728	4,728	7,092	5,201	8,510
00690	6.90	156	102	3,384	4,728	4,728	7,092	5,201	8,510
00700	7.00	156	102	3,384	4,728	4,728	7,092	5,201	8,510
00710	7.10	156	102	4,200	5,880	5,880	8,820	6,468	10,584
00720	7.20	156	102	4,200	5,880	5,880	8,820	6,468	10,584
00725	7.25	156	102	4,200	5,880	5,880	8,820	6,468	10,584
00730	7.30	156	102	4,200	5,880	5,880	8,820	6,468	10,584
00740	7.40	156	102	4,200	5,880	5,880	8,820	6,468	10,584
00750	7.50	156	102	3,648	5,100	5,100	7,656	5,610	9,187
00760	7.60	165	109	4,356	6,096	6,096	9,144	6,706	10,973
00770	7.70	165	109	4,356	6,096	6,096	9,144	6,706	10,973
00775	7.75	165	109	4,356	6,096	6,096	9,144	6,706	10,973
00780	7.80	165	109	4,356	6,096	6,096	9,144	6,706	10,973

*Posebno označene stavke (**bold**) odnose se na robu koju imamo na lageru. Za ostali asortiman rabate i rokove isporuke dajemo na osnovu upita.

*Items given in **bold** figures refer to products on stock. Discount and delivery terms for other product assortment are given at request.

*Die separat gekennzeichneten artikel (**bold**) beziehen sich auf die Ware, die auf Lager liegt. Die Rabatte und Lieferzeiten für das restliche Sortiment geben wir auf Anfrage bekannt.

Series				BV31	BV32	BV33	BV34	BV35	BV36
	Material			HSS	HSS	HSS	Co 5%	HSS	Co 5%
	Type			RN	RN	RN	RN	RN	RS
	Point angle			118°	118°	118°	130°/C	130°/C	130°/C
	Execution			rolled	ground	ground	ground	ground	ground
	Finish			black	black	bright	bright	black	bright
	d	l ₁	l ₂	price EUR					
	mm	mm	mm	each	each	each	each	each	each
00790	7.90	165	109	4,356	6,096	6,096	9,144	6,706	10,973
00800	8.00	165	109	4,044	5,652	5,652	8,484	6,217	10,181
00810	8.10	165	109	4,668	6,540	6,540	9,816	7,194	11,779
00820	8.20	165	109	4,668	6,540	6,540	9,816	7,194	11,779
00825	8.25	165	109	4,908	6,876	6,876	10,308	7,564	12,370
00830	8.30	165	109	4,668	6,540	6,540	9,816	7,194	11,779
00840	8.40	165	109	4,908	6,876	6,876	10,308	7,564	12,370
00850	8.50	165	109	4,440	6,204	6,204	9,312	6,824	11,174
00860	8.60	175	115	5,676	7,944	7,944	11,916	8,738	14,299
00870	8.70	175	115	5,676	7,944	7,944	11,916	8,738	14,299
00875	8.75	175	115	7,608	10,644	10,644	15,972	11,708	19,166
00880	8.80	175	115	5,676	7,944	7,944	11,916	8,738	14,299
00890	8.90	175	115	5,676	7,944	7,944	11,916	8,738	14,299
00900	9.00	175	115	4,752	6,648	6,648	9,984	7,313	11,981
00910	9.10	175	115	5,988	8,388	8,388	12,588	9,227	15,106
00920	9.20	175	115	5,988	8,388	8,388	12,588	9,227	15,106
00925	9.25	175	115	7,764	10,872	10,872	16,296	11,959	19,555
00930	9.30	175	115	5,988	8,388	8,388	12,588	9,227	15,106
00940	9.40	175	115	5,988	8,388	8,388	12,588	9,227	15,106
00950	9.50	175	115	4,836	6,768	6,768	10,140	7,445	12,168
00960	9.60	184	121	5,988	8,388	8,388	12,588	9,227	15,106
00970	9.70	184	121	5,988	8,388	8,388	12,588	9,227	15,106
00975	9.75	184	121	8,136	11,388	11,388	17,076	12,527	20,491
00980	9.80	184	121	5,988	8,388	8,388	12,588	9,227	15,106
00990	9.90	184	121	5,988	8,388	8,388	12,588	9,227	15,106
01000	10.00	184	121	5,196	7,284	7,284	10,920	8,012	13,104
01020	10.20	184	121	8,136	11,388	11,388	17,076	12,527	20,491
01025	10.25	184	121	8,136	11,388	11,388	17,076	12,527	20,491
01050	10.50	184	121	7,104	9,948	9,948	14,916	10,943	17,899
01075	10.75	195	128	8,532	11,940	11,940	17,904	13,134	21,485
01100	11.00	195	128	7,764	10,872	10,872	16,296	11,959	19,555
01150	11.50	195	128	7,920	11,088	11,088	16,632	12,197	19,958
01200	12.00	205	134	8,712	12,192	12,192	18,300	13,411	21,960
01250	12.50	205	134	9,108	12,756	12,756	19,128	14,032	22,954
01300	13.00	205	134	10,296	14,412	14,412	21,624	15,853	25,949
01350	13.50	214	140	11,268	15,780	15,780	23,676	17,358	28,411
01400	14.00	214	140	12,096	16,932	16,932	25,392	18,625	30,470
01450	14.50	220	144	14,256	19,956	19,956	29,940	21,952	35,928
01500	15.00	220	144	13,860	19,404	19,404	29,112	21,344	34,934
01550	15.50	227	149	16,056	22,476	22,476	33,708	24,724	40,450
01600	16.00	227	149	16,056	22,476	22,476	33,708	24,724	40,450
01650	16.50	235	154	17,820	24,948	24,948	37,428	27,443	44,914
01700	17.00	235	154	17,820	24,948	24,948	37,428	27,443	44,914
01750	17.50	241	158	18,612	26,052	26,052	39,084	28,657	46,901
01800	18.00	241	158	18,612	26,052	26,052	39,084	28,657	46,901
01850	18.50	247	162	22,968	32,160	32,160	48,228	35,376	57,874
01900	19.00	247	162	22,968	32,160	32,160	48,228	35,376	57,874
01950	19.50	254	166	25,740	36,036	36,036	54,060	39,640	64,872
02000	20.00	254	166	25,740	36,036	36,036	54,060	39,640	64,872

*Posebno označene stavke (**bold**) odnose se na robu koju imamo na lageru. Za ostali asortiman rabate i rokove isporuke dajemo na osnovu upita.

*Items given in **bold** figures refer to products on stock. Discount and delivery terms for other product assortment are given at request.

*Die separat gekennzeichneten artikel (**bold**) beziehen sich auf die Ware, die auf Lager liegt. Die Rabatte und Lieferzeiten für das restliche Sortiment geben wir auf Anfrage bekannt.

SPIRALNE BURGIJE VALJKASTE, PRODUŽENE
EXTRA LONG TWIST DRILLS, STRAIGHT SHANK
ÜBERLANGE SPIRALBOHRER, ZYLINDERSCHAFT

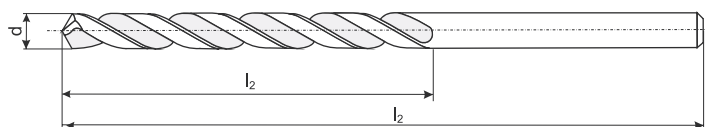
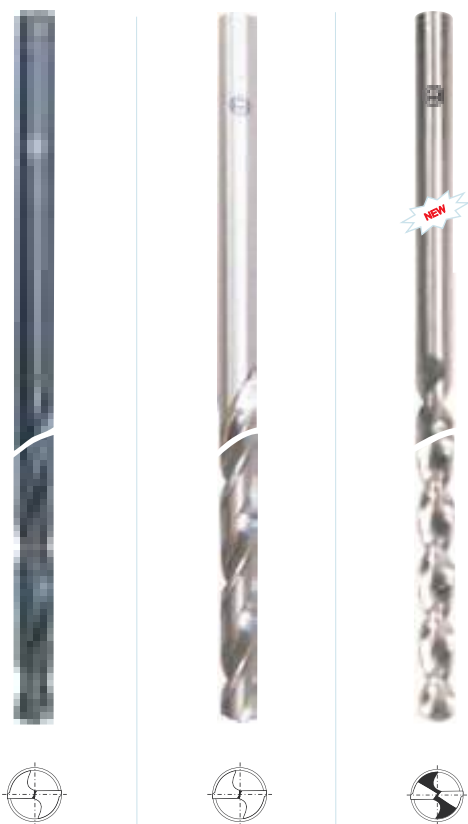

Series				BV41	BV42	BV43
Material				HSS	HSS	HSS
Type				RN	RN	RS
Point angle				118°	118°	130°/C
Execution				ground	ground	ground
Finish				black	bright	bright
	d	l ₁	l ₂	price EUR		
	mm	mm	mm	each	each	each
00200	2.00	125	85	5,280	5,280	6,336
00250	2.50	140	95	5,520	5,520	6,624
00300	3.00	150	100	6,180	6,180	7,416
00350	3.50	165	115	6,360	6,360	7,632
00400	4.00	175	120	6,480	6,480	7,776
00450	4.50	185	125	7,200	7,200	8,640
00500	5.00	195	135	7,380	7,380	8,856
00550	5.50	205	140	8,400	8,400	10,080
00600	6.00	205	140	8,400	8,400	10,080
00650	6.50	215	150	10,500	10,500	12,600
00700	7.00	225	155	12,000	12,000	14,400
00750	7.50	225	155	14,160	14,160	16,992
00800	8.00	240	165	15,360	15,360	18,432
00850	8.50	240	165	19,800	19,800	23,760
00900	9.00	250	170	21,000	21,000	25,200
00950	9.50	250	170	24,000	24,000	28,800
01000	10.00	265	180	22,200	22,200	26,640
01050	10.50	265	185	26,640	26,640	31,968
01100	11.00	280	195	29,880	29,880	35,856
01150	11.50	280	195	32,640	32,640	39,168
01200	12.00	295	205	39,480	39,480	47,376
01250	12.50	295	205	41,400	41,400	49,680
01300	13.00	295	205	39,720	39,720	47,664

*Posebno označene stavke (**bold**) odnose se na robu koju imamo na lageru. Za ostali asortiman rabate i rokove isporuke dajemo na osnovu upita.

*Items given in **bold** figures refer to products on stock. Discount and delivery terms for other product assortment are given at request.

*Die separat gekennzeichneten artikel (**bold**) beziehen sich auf die Ware, die auf Lager liegt. Die Rabatte und Lieferzeiten für das restliche Sortiment geben wir auf Anfrage bekannt.

SPIRALNE BURGIJE VALJKASTE, PRODUŽENE
EXTRA LONG TWIST DRILLS, STRAIGHT SHANK
ÜBERLANGE SPIRALBOHRER, ZYLINDERSCHAFT

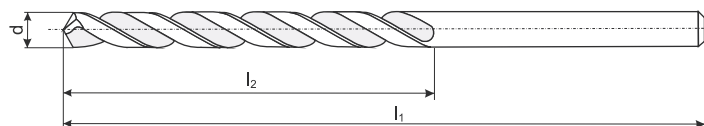

Series				BV44	BV45	BV46
	Material			HSS	HSS	HSS
	Type			RN	RN	RS
	Point angle			118°	118°	130°/C
	Execution			ground	ground	ground
	Finish			black	bright	bright
	d	l ₁	l ₂	price EUR		
	mm	mm	mm	each	each	each
00300	3.00	190	130	7,560	7,560	9,072
00350	3.50	210	145	8,040	8,040	9,648
00400	4.00	220	150	8,100	8,100	9,720
00450	4.50	235	160	9,840	9,840	11,808
00500	5.00	245	170	9,480	9,480	11,376
00550	5.50	260	180	12,600	12,600	15,120
00600	6.00	260	180	12,300	12,300	14,760
00650	6.50	275	190	13,800	13,800	16,560
00700	7.00	290	200	15,600	15,600	18,720
00750	7.50	290	200	18,600	18,600	22,320
00800	8.00	305	210	18,600	18,600	22,320
00850	8.50	305	210	25,200	25,200	30,240
00900	9.00	320	220	25,800	25,800	30,960
00950	9.50	320	220	30,600	30,600	36,720
01000	10.00	340	235	29,400	29,400	35,280
01050	10.50	340	235	38,400	38,400	46,080
01100	11.00	365	260	44,040	44,040	52,848
01150	11.50	365	260	49,080	49,080	58,896
01200	12.00	375	260	49,440	49,440	59,328
01250	12.50	375	260	52,320	52,320	62,784
01300	13.00	375	260	51,600	51,600	61,920

*Posebno označene stavke (**bold**) odnose se na robu koju imamo na lageru. Za ostali asortiman rabate i rokove isporuke dajemo na osnovu upita.

*Items given in **bold** figures refer to products on stock. Discount and delivery terms for other product assortment are given at request.

*Die separat gekennzeichneten artikel (**bold**) beziehen sich auf die Ware, die auf Lager liegt. Die Rabatte und Lieferzeiten für das restliche Sortiment geben wir auf Anfrage bekannt.

SPIRALNE BURGIJE VALJKASTE, PRODUŽENE
EXTRA LONG TWIST DRILLS, STRAIGHT SHANK
ÜBERLANGE SPIRALBOHRER, ZYLINDERSCHAFT

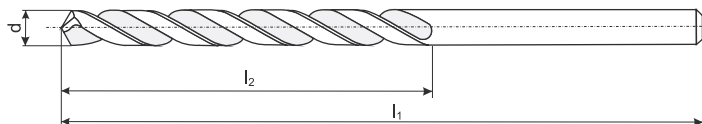

Series				BV47	BV48	BV49
	Material			HSS	HSS	HSS
	Type			RN	RN	RS
	Point angle			118°	118°	130°/C
	Execution			ground	ground	ground
	Finish			black	bright	bright
	d	l ₁	l ₂	price EUR		
	mm	mm	mm	each	each	each
00350	3.50	265	180	11,400	11,400	13,680
00400	4.00	280	190	10,680	10,680	12,816
00450	4.50	295	200	14,400	14,400	17,280
00500	5.00	315	210	13,740	13,740	16,488
00550	5.50	330	225	15,360	15,360	18,432
00600	6.00	330	225	15,600	15,600	18,720
00650	6.50	350	235	17,400	17,400	20,880
00700	7.00	370	250	22,800	22,800	27,360
00750	7.50	370	250	25,800	25,800	30,960
00800	8.00	390	265	26,400	26,400	31,680
00850	8.50	390	265	33,600	33,600	40,320
00900	9.00	410	280	37,200	37,200	44,640
00950	9.50	410	280	41,400	41,400	49,680
01000	10.00	430	295	39,600	39,600	47,520
01050	10.50	430	295	43,440	43,440	52,128
01100	11.00	455	310	49,560	49,560	59,472
01150	11.50	455	310	53,280	53,280	63,936
01200	12.00	480	330	55,560	55,560	66,672
01250	12.50	480	330	55,560	55,560	66,672
01300	13.00	480	330	57,120	57,120	68,544

*Posebno označene stavke (**bold**) odnose se na robu koju imamo na lageru. Za ostali asortiman rabate i rokove isporuke dajemo na osnovu upita.

*Items given in **bold** figures refer to products on stock. Discount and delivery terms for other product assortment are given at request.

*Die separat gekennzeichneten artikel (**bold**) beziehen sich auf die Ware, die auf Lager liegt. Die Rabatte und Lieferzeiten für das restliche Sortiment geben wir auf Anfrage bekannt.

**SPIRALNE BURGJE KUPASTE,
NORMALNE**

**MORSE TAPER SHANK
TWIST DRILLS**

**SPIRALBOHRER MIT
MORSEKEGELSCHAFT**

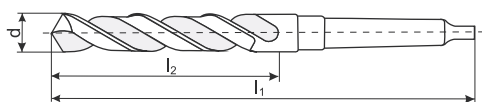

Series					BK01	BK02	BK03	BK05	
					HSS	HSS	HSS	Co 5%	
				Type	RN	RN	RN	RN	
				Point angle	118°/A	118°/A	118°/A	118°/A	
				Execution	rolled	milled	milled	milled	
				Finish	black	black	b/b	b/b	
		d	l ₁	l ₂	price EUR				
		mm	mm	mm	MT	each	each	each	each
00300		3.00	114	33	1	8,288	11,056	11,741	17,690
00320		3.20	117	36	1	8,752	11,680	12,404	18,688
00325		3.25	117	36	1	8,752	11,680	12,404	18,688
00350		3.50	120	39	1	7,936	10,576	11,232	16,922
00375		3.75	120	36	1	8,752	11,680	12,404	18,688
00380		3.80	124	43	1	8,752	11,680	12,404	18,688
00400		4.00	124	43	1	7,504	10,016	10,637	16,026
00420		4.20	124	43	1	8,448	11,264	11,962	18,022
00425		4.25	124	43	1	8,448	11,264	11,962	18,022
00450		4.50	128	47	1	7,424	9,904	10,518	15,846
00475		4.75	128	47	1	8,448	11,264	11,962	18,022
00480		4.80	133	52	1	8,448	11,264	11,962	18,022
00500		5.00	133	52	1	7,136	9,520	10,110	15,232
00520		5.20	133	52	1	8,064	10,752	11,419	17,203
00525		5.25	133	52	1	8,064	10,752	11,419	17,203
00550		5.50	138	57	1	7,008	9,344	9,923	14,950
00575		5.75	138	57	1	8,064	10,752	11,419	17,203
00580		5.80	138	57	1	8,064	10,752	11,419	17,203
00600		6.00	138	57	1	6,912	9,216	9,787	14,746
00620		6.20	144	63	1	8,064	10,752	11,419	17,203
00625		6.25	144	63	1	8,064	10,752	11,419	17,203
00650		6.50	144	63	1	6,544	8,736	9,278	13,978
00675		6.75	150	69	1	7,680	10,240	10,875	16,384
00680		6.80	150	69	1	7,680	10,240	10,875	16,384
00700		7.00	150	69	1	6,816	9,088	9,651	14,541
00720		7.20	150	69	1	8,064	10,752	11,419	17,203
00725		7.25	150	69	1	8,064	10,752	11,419	17,203
00750		7.50	150	69	1	7,232	9,648	10,246	15,437
00775		7.75	156	75	1	8,448	11,264	11,962	18,022
00780		7.80	156	75	1	8,448	11,264	11,962	18,022
00800		8.00	156	75	1	7,232	9,648	10,246	15,437
00820		8.20	156	75	1	8,448	11,264	11,962	18,022

*Posebno označene stavke (**bold**) odnose se na robu koju imamo na lageru. Za ostali asortiman rabate i rokove isporuke dajemo na osnovu upita.

*Items given in **bold** figures refer to products on stock. Discount and delivery terms for other product assortment are given at request.

*Die separat gekennzeichneten artikel (**bold**) beziehen sich auf die Ware, die auf Lager liegt. Die Rabatte und Lieferzeiten für das restliche Sortiment geben wir auf Anfrage bekannt.

Series					BK01	BK02	BK03	BK05
	Material				HSS	HSS	HSS	Co 5%
	Type				RN	RN	RN	RN
	Point angle				18°/A	118°/A	118°/A	118°/A
Execution				rolled	milled	milled	milled	
Finish				black	black	b/b	b/b	
d		l ₁	l ₂	MT	price EUR			
mm	mm	mm	each		each	each	each	
00825	8.25	156	75	1	8,448	11,264	11,962	18,022
00850	8.50	156	75	1	7,424	9,904	10,518	15,846
00875	8.75	162	81	1	8,832	11,776	12,506	18,842
00880	8.80	162	81	1	8,832	11,776	12,506	18,842
00900	9.00	162	81	1	8,288	11,056	11,741	17,690
00920	9.20	162	81	1	9,216	12,288	13,050	19,661
00925	9.25	162	81	1	9,216	12,288	13,050	19,661
00950	9.50	162	81	1	8,288	11,056	11,741	17,690
00975	9.75	168	87	1	13,824	18,432	19,575	29,491
00980	9.80	168	87	1	13,824	18,432	19,575	29,491
01000	10.00	168	87	1	8,384	11,184	11,877	17,894
01020	10.20	168	87	1	12,100	16,120	17,119	25,792
01025	10.25	168	87	1	12,100	16,120	17,119	25,792
01050	10.50	168	87	1	11,800	15,740	16,716	25,184
01075	10.75	175	94	1	12,380	16,520	17,544	26,432
01080	10.80	175	94	1	12,380	16,520	17,544	26,432
01100	11.00	175	94	1	11,520	15,360	16,312	24,576
01120	11.20	175	94	1	12,960	17,280	18,351	27,648
01125	11.25	175	94	1	12,960	17,280	18,351	27,648
01150	11.50	175	94	1	12,380	16,520	17,544	26,432
01175	11.75	175	94	1	13,440	17,920	19,031	28,672
01180	11.80	175	94	1	13,440	17,920	19,031	28,672
01200	12.00	182	101	1	12,960	17,280	18,351	27,648
01220	12.20	182	101	1	14,400	19,200	20,390	30,720
01225	12.25	182	101	1	14,400	19,200	20,390	30,720
01250	12.50	182	101	1	13,540	18,040	19,158	28,864
01275	12.75	182	101	1	14,880	19,840	21,070	31,744
01280	12.80	182	101	1	14,880	19,840	21,070	31,744
01300	13.00	182	101	1	13,540	18,040	19,158	28,864
01320	13.20	182	101	1	15,840	21,120	22,429	33,792
01325	13.25	189	108	1	15,840	21,120	22,429	33,792
01350	13.50	189	108	1	14,680	19,580	20,794	31,328
01375	13.75	189	108	1	15,840	21,120	22,429	33,792
01380	13.80	189	108	1	15,840	21,120	22,429	33,792
01400	14.00	189	108	1	15,560	20,740	22,026	33,184
01425	14.25	212	114	2	18,060	24,070	25,561	38,509
01450	14.50	212	114	2	16,420	21,880	23,237	35,008
01475	14.75	212	114	2	18,720	24,960	26,508	39,936
01500	15.00	212	114	2	18,140	24,200	25,700	38,720
01525	15.25	218	120	2	19,300	25,720	27,315	41,152
01550	15.50	218	120	2	18,720	24,960	26,508	39,936
01575	15.75	218	120	2	20,640	27,520	29,226	44,032
01600	16.00	218	120	2	18,720	24,960	26,508	39,936
01625	16.25	223	125	2	20,740	27,640	29,354	44,224
01650	16.50	223	125	2	19,880	26,500	28,143	42,400
01675	16.75	223	125	2	20,740	27,640	29,354	44,224
01700	17.00	223	125	2	19,880	26,500	28,143	42,400
01725	17.25	228	130	2	23,320	31,100	33,028	49,760
01750	17.50	228	130	2	21,020	28,040	29,778	44,864
01775	17.75	228	130	2	23,040	30,720	32,625	49,152
01800	18.00	228	130	2	23,860	29,960	31,818	47,936

*Posebno označene stavke (**bold**) odnose se na robu koju imamo na lageru. Za ostali asortiman rabate i rokove isporuke dajemo na osnovu upita.

*Items given in **bold** figures refer to products on stock. Discount and delivery terms for other product assortment are given at request.

*Die separat gekennzeichneten artikel (**bold**) beziehen sich auf die Ware, die auf Lager liegt. Die Rabatte und Lieferzeiten für das restliche Sortiment geben wir auf Anfrage bekannt.

Series					BK01	BK02	BK03	BK05
	Material				HSS	HSS	HSS	Co 5%
	Type				RN	RN	RN	RN
	Point angle				18°/A	118°/A	118°/A	118°/A
Execution				rolled	milled	milled	milled	
Finish				black	black	b/b	b/b	
d		l ₁	l ₂	MT	price EUR			
mm	mm	mm	each		each	each	each	
01825	18.25	233	135	2	23,900	31,880	33,857	51,008
01850	18.50	233	135	2	23,320	31,100	33,028	49,760
01875	18.75	233	135	2	24,480	32,640	34,664	52,224
01900	19.00	233	135	2	23,320	31,100	33,028	49,760
01925	19.25	238	140	2	25,920	34,560	36,703	55,296
01950	19.50	238	140	2	24,480	32,640	34,664	52,224
01975	19.75	238	140	2	25,920	34,560	36,703	55,296
02000	20.00	238	140	2	24,480	32,640	34,664	52,224
02025	20.25	243	145	2	29,380	39,160	41,588	62,656
02050	20.50	243	145	2	28,520	38,020	40,377	60,832
02075	20.75	243	145	2		39,940	42,416	63,904
02100	21.00	243	145	2		38,020	40,377	60,832
02125	21.25	248	150	2		42,240	44,859	67,584
02150	21.50	248	150	2		41,480	44,052	66,368
02175	21.75	248	150	2		42,240	44,859	67,584
02200	22.00	248	150	2		41,480	44,052	66,368
02225	22.25	248	150	2		44,540	47,301	71,264
02250	22.50	253	155	2		43,780	46,494	70,048
02275	22.75	253	155	2		48,000	50,976	76,800
02300	23.00	253	155	2		47,620	50,572	76,192
02325	23.25	276	155	3		51,200	54,374	81,920
02350	23.50	276	155	3		48,380	51,380	77,408
02375	23.75	281	160	3		54,400	57,773	87,040
02400	24.00	281	160	3		53,000	56,286	84,800
02425	24.25	281	160	3		57,600	61,171	92,160
02450	24.50	281	160	3		54,520	57,900	87,232
02475	24.75	281	160	3		57,600	61,171	92,160
02500	25.00	281	160	3		49,160	52,208	78,656
02525	25.25	286	165	3		64,000	67,968	102,400
02550	25.50	286	165	3		61,440	65,249	98,304
02575	25.75	286	165	3		64,000	67,968	102,400
02600	26.00	286	165	3		62,200	66,056	99,520
02625	26.25	286	165	3		70,400	74,765	112,640
02650	26.50	286	165	3		62,980	66,885	100,768
02675	26.75	291	170	3		73,600	78,163	117,760
02700	27.00	291	170	3		66,820	70,963	106,912
02725	27.25	291	170	3		75,520	80,202	120,832
02750	27.50	291	170	3		69,120	73,405	110,592
02775	27.75	291	170	3		75,520	80,202	120,832
02800	28.00	291	170	3		69,120	73,405	110,592
02825	28.25	296	175	3		80,000	84,960	128,000
02850	28.50	296	175	3		73,720	78,291	117,952
02875	28.75	296	175	3		80,000	84,960	128,000
02900	29.00	296	175	3		75,260	79,926	120,416
02925	29.25	296	175	3		81,920	86,999	131,072
02950	29.50	296	175	3		75,260	79,926	120,416
02975	29.75	296	175	3		81,920	86,999	131,072
03000	30.00	296	175	3		79,100	84,004	126,560
03025	30.25	301	180	3		93,700	99,509	149,920
03050	30.50	301	180	3		93,700	99,509	149,920
03075	30.75	301	180	3		96,760	102,759	154,816

*Posebno označene stavke (**bold**) odnose se na robu koju imamo na lageru. Za ostali asortiman rabate i rokove isporuke dajemo na osnovu upita.

*Items given in **bold** figures refer to products on stock. Discount and delivery terms for other product assortment are given at request.

*Die separat gekennzeichneten artikel (**bold**) beziehen sich auf die Ware, die auf Lager liegt. Die Rabatte und Lieferzeiten für das restliche Sortiment geben wir auf Anfrage bekannt.

Series					BK01	BK02	BK03	BK05
	Material				HSS	HSS	HSS	Co 5%
	Type				RN	RN	RN	RN
	Point angle				18°/A	118°/A	118°/A	118°/A
Execution				rolled	milled	milled	milled	
Finish				black	black	b/b	b/b	
d		l ₁	l ₂	MT	price EUR			
mm	mm	mm	each		each	each	each	
03100	31.00	301	180	3		89,860	95,431	143,776
03125	31.25	301	180	3		98,300	104,395	157,280
03150	31.50	301	180	3		98,300	104,395	157,280
03175	31.75	306	185	3		98,300	104,395	157,280
03200	32.00	334	185	4		100,600	106,837	160,960
03250	32.50	334	185	4		105,980	112,551	169,568
03300	33.00	334	185	4		106,760	113,379	170,816
03350	33.50	334	185	4		117,500	124,785	188,000
03400	34.00	339	190	4		117,500	124,785	188,000
03450	34.50	339	190	4		132,100	140,290	211,360
03500	35.00	339	190	4		119,800	127,228	191,680
03550	35.50	339	190	4		132,860	141,097	212,576
03600	36.00	344	195	4		133,640	141,926	213,824
03650	36.50	344	195	4		143,620	152,524	229,792
03700	37.00	344	195	4		138,240	146,811	221,184
03750	37.50	344	195	4		152,060	161,488	243,296
03800	38.00	349	200	4		152,840	162,316	244,544
03850	38.50	349	200	4		181,240	192,477	289,984
03900	39.00	349	200	4		156,680	166,394	250,688
03950	39.50	349	200	4		184,320	195,748	294,912
04000	40.00	349	200	4		162,820	172,915	260,512
04050	40.50	354	205	4		193,540	205,539	309,664
04100	41.00	354	205	4		179,720	190,863	287,552
04150	41.50	354	205	4		207,360	220,216	331,776
04200	42.00	354	205	4		187,400	199,019	299,840
04250	42.50	354	205	4		211,960	225,102	339,136
04300	43.00	359	210	4		205,820	218,581	329,312
04350	43.50	359	210	4		235,000	249,570	376,000
04400	44.00	359	210	4		210,440	223,487	336,704
04450	44.50	359	210	4		250,360	265,882	400,576
04500	45.00	359	210	4		224,260	238,164	358,816
04550	45.50	364	215	4		253,440	269,153	405,504
04600	46.00	364	215	4		225,800	239,800	361,280
04650	46.50	364	215	4		284,160	301,778	454,656
04700	47.00	364	215	4		239,620	254,476	383,392
04750	47.50	364	215	4		291,840	309,934	466,944
04800	48.00	369	220	4		261,120	277,309	417,792
04850	48.50	369	220	4		302,600	321,361	484,160
04900	49.00	369	220	4		267,260	283,830	427,616
04950	49.50	369	220	4		305,660	324,611	489,056
05000	50.00	369	220	4		273,400	290,351	437,440
05050	50.50	374	225	4		321,280	341,199	514,048
05100	51.00	412	225	5		333,440	354,113	533,504
05150	51.50	412	225	5		352,000	373,824	563,200
05200	52.00	412	225	5		346,880	368,387	555,008
05250	52.50	412	225	5		371,840	394,894	594,944
05300	53.00	412	225	5		352,000	373,824	563,200
05350	53.50	417	230	5		399,360	424,120	638,976
05400	54.00	417	230	5		377,600	401,011	604,160
05450	54.50	417	230	5		407,040	432,276	651,264
05500	55.00	417	230	5		384,000	407,808	614,400

*Posebno označene stavke (**bold**) odnose se na robu koju imamo na lageru. Za ostali asortiman rabate i rokove isporuke dajemo na osnovu upita.

*Items given in **bold** figures refer to products on stock. Discount and delivery terms for other product assortment are given at request.

*Die separat gekennzeichneten artikel (**bold**) beziehen sich auf die Ware, die auf Lager liegt. Die Rabatte und Lieferzeiten für das restliche Sortiment geben wir auf Anfrage bekannt.

Series					BK01	BK02	BK03	BK05
	Material				HSS	HSS	HSS	Co 5%
	Type				RN	RN	RN	RN
	Point angle				18°/A	118°/A	118°/A	118°/A
Execution				rolled	milled	milled	milled	
Finish				black	black	b/b	b/b	
d	l ₁	l ₂	MT	price EUR				
				each	each	each	each	
mm	mm	mm						
05550	55.50	417	230	5		407,040	432,276	651,264
05600	56.00	417	230	5		384,000	407,808	614,400
05650	56.50	422	235	5		430,080	456,745	688,128
05700	57.00	422	235	5		407,040	432,276	651,264
05750	57.50	422	235	5		445,440	473,057	712,704
05800	58.00	422	235	5		430,080	456,745	688,128
05850	58.50	422	235	5		445,440	473,057	712,704
05900	59.00	422	235	5		430,080	456,745	688,128
05950	59.50	422	235	5		468,480	497,526	749,568
06000	60.00	422	235	5		445,440	473,057	712,704
06100	61.00	427	240	5		491,520	521,994	786,432
06200	62.00	427	240	5		499,200	530,150	798,720
06300	63.00	427	240	5		529,920	562,775	847,872
06400	64.00	432	245	5		568,320	603,556	909,312
06500	65.00	432	245	5		583,680	619,868	933,888
06600	66.00	432	245	5		629,760	668,805	1007,616
06700	67.00	432	245	5		629,760	668,805	1007,616
06800	68.00	437	250	5		668,160	709,586	1069,056
06900	69.00	437	250	5		714,240	758,523	1142,784
07000	70.00	437	250	5		737,280	782,991	1179,648
07100	71.00	437	250	5		752,640	799,304	1204,224
07200	72.00	442	255	5		783,360	831,928	1253,376
07300	73.00	442	255	5		814,080	864,553	1302,528
07400	74.00	442	255	5		860,160	913,490	1376,256
07500	75.00	442	255	5		875,520	929,802	1400,832
07600	76.00	447	260	5		952,320	1011,364	1523,712
07700	77.00	514	260	6		983,040	1043,988	1572,864
07800	78.00	514	260	6		1013,760	1076,613	1622,016
07900	79.00	514	260	6		1059,840	1125,550	1695,744
08000	80.00	514	260	6		1090,560	1158,175	1744,896
08100	81.00	519	265	6		1152,000	1223,424	1843,200
08200	82.00	519	265	6		1167,360	1239,736	1867,776
08300	83.00	519	265	6		1213,440	1288,673	1941,504
08400	84.00	519	265	6		1213,440	1288,673	1941,504
08500	85.00	519	265	6		1228,800	1304,986	1966,080
08600	86.00	524	270	6		1259,520	1337,610	2015,232
08700	87.00	524	270	6		1274,880	1353,923	2039,808
08800	88.00	524	270	6		1305,600	1386,547	2088,960
08900	89.00	524	270	6		1336,320	1419,172	2138,112
09000	90.00	524	270	6		1336,320	1419,172	2138,112
09100	91.00	529	275	6		1443,840	1533,358	2310,144
09200	92.00	529	275	6		1505,280	1598,607	2408,448
09300	93.00	529	275	6		1520,640	1614,920	2433,024
09400	94.00	529	275	6		1520,640	1614,920	2433,024
09500	95.00	529	275	6		1551,360	1647,544	2482,176
09600	96.00	534	280	6		1597,440	1696,481	2555,904
09700	97.00	534	280	6		1628,160	1729,106	2605,056
09800	98.00	534	280	6		1658,880	1761,731	2654,208
09900	99.00	534	280	6		1781,760	1892,229	2850,816
10000	100.00	534	280	6		1781,760	1892,229	2850,816

*Posebno označene stavke (**bold**) odnose se na robu koju imamo na lageru. Za ostali asortiman rabate i rokove isporuke dajemo na osnovu upita.

*Items given in **bold** figures refer to products on stock. Discount and delivery terms for other product assortment are given at request.

*Die separat gekennzeichneten artikel (**bold**) beziehen sich auf die Ware, die auf Lager liegt. Die Rabatte und Lieferzeiten für das restliche Sortiment geben wir auf Anfrage bekannt.

SPIRALNE BURGIJE KUPASTE, SA OJAČANOM DRŠKOM

MORSE TAPER SHANK TWIST DRILLS, OVERSIZE SHANK

SPIRALBOHRER MIT GROSSEREM MORSEKEGELSCHAFT

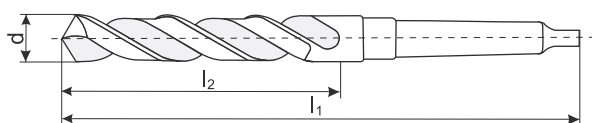

Series					BK11
	Material				HSS
	Type				RN
	Point angle				118°/A
	Finish				black
	d	l ₁	l ₂	MT	price EUR
	mm	mm	mm		each
01200	12.00	199	101	2	25,472
01250	12.50	199	101	2	24,320
01300	13.00	199	101	2	24,960
01350	13.50	206	108	2	26,240
01400	14.00	206	108	2	27,520
01450	14.50	231	114	3	29,440
01500	15.00	231	114	3	32,640
01850	18.50	256	135	3	39,040
01900	19.00	256	135	3	39,040
01950	19.50	261	140	3	42,880
02000	20.00	261	140	3	42,880
02050	20.50	266	145	3	46,720
02100	21.00	266	145	3	46,720
02150	21.50	271	150	3	52,480
02200	22.00	271	150	3	52,480
02250	22.50	276	155	3	52,480
02300	23.00	276	155	3	60,160
02700	27.00	319	170	4	80,000
02750	27.50	319	170	4	83,200
02800	28.00	319	170	4	83,200
02850	28.50	324	175	4	89,600
02900	29.00	324	175	4	92,800
02950	29.50	324	175	4	96,000
03000	30.00	324	175	4	96,000
03050	30.50	329	180	4	112,000
03100	31.00	329	180	4	112,000
03150	31.50	329	180	4	115,200
04050	40.50	392	205	5	204,800

*Posebno označene stavke (**bold**) odnose se na robu koju imamo na lageru. Za ostali asortiman rabate i rokove isporuke dajemo na osnovu upita.

*Items given in **bold** figures refer to products on stock. Discount and delivery terms for other product assortment are given at request.

*Die separat gekennzeichneten artikel (**bold**) beziehen sich auf die Ware, die auf Lager liegt. Die Rabatte und Lieferzeiten für das restliche Sortiment geben wir auf Anfrage bekannt.

Series						<i>BK11</i>
	Material					HSS
	Type					RN
	Point angle					118°/A
Finish					black	
	d	l ₁	l ₂	MT	price EUR	
	mm	mm	mm		each	
04100	41.00	392	205	5	204,800	
04200	42.00	392	205	5	211,200	
04300	43.00	392	205	5	236,800	
04400	44.00	397	205	5	243,200	
04500	45.00	397	205	5	249,600	
04600	46.00	402	215	5	262,400	
04700	47.00	402	215	5	268,800	
04800	48.00	407	220	5	288,000	
04900	49.00	407	220	5	294,400	
05000	50.00	407	220	5	300,800	
06400	64.00	499	245	6	625,280	
06500	65.00	499	245	6	641,920	
06600	66.00	499	245	6	692,480	
06700	67.00	499	245	6	692,480	
06800	68.00	504	250	6	734,720	
06900	69.00	504	250	6	785,920	
07000	70.00	504	250	6	810,880	
07100	71.00	504	250	6	827,520	
07200	72.00	509	255	6	861,440	
07300	73.00	509	255	6	895,360	
07400	74.00	509	255	6	945,920	
07500	75.00	509	255	6	963,200	
07600	76.00	514	260	6	1.047,680	

*Posebno označene stavke (**bold**) odnose se na robu koju imamo na lageru. Za ostali asortiman rabate i rokove isporuke dajemo na osnovu upita.

*Items given in **bold** figures refer to products on stock. Discount and delivery terms for other product assortment are given at request.

*Die separat gekennzeichneten artikel (**bold**) beziehen sich auf die Ware, die auf Lager liegt. Die Rabatte und Lieferzeiten für das restliche Sortiment geben wir auf Anfrage bekannt.

SPIRALNE BURGIJE KUPASTE, DUGE

TWIST DRILLS TAPER SHANK, LONG SERIES

SPIRALBOHRER MIT MORSEKEGELSCHAFT, LANGE

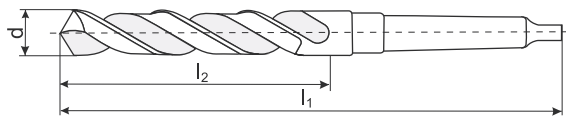

Series					BK15	BK16
	Material				HSS	HSS
	Type				RN	RN
	Point angle				118°/A	118°/A
	Finish				black	b/b
	d	l ₁	l ₂	MT	price EUR	
	mm	mm	mm		each	each
00500	5.00	155	74	1	19,360	21,296
00550	5.50	161	80	1	18,960	20,864
00600	6.00	161	80	1	18,720	20,592
00650	6.50	167	86	1	17,760	19,536
00700	7.00	174	93	1	18,480	20,336
00750	7.50	174	93	1	19,600	21,568
00800	8.00	181	100	1	19,600	21,568
00850	8.50	181	100	1	20,240	22,272
00900	9.00	188	107	1	22,480	24,736
00950	9.50	188	107	1	22,480	24,736
01000	10.00	197	116	1	22,800	25,088
01050	10.50	197	116	1	23,920	26,320
01100	11.00	206	125	1	24,960	27,456
01150	11.50	206	125	1	26,880	29,568
01200	12.00	215	134	1	28,080	30,896
01250	12.50	215	134	1	29,360	32,304
01300	13.00	215	134	1	29,360	32,304
01350	13.50	233	142	1	31,840	35,024
01400	14.00	233	142	1	33,760	37,136
01450	14.50	245	147	2	35,600	39,168
01500	15.00	245	147	2	39,200	43,120
01550	15.50	251	153	2	40,800	44,880
01600	16.00	251	153	2	40,800	44,880
01650	16.50	257	159	2	43,200	47,520
01700	17.00	257	159	2	43,200	47,520
01750	17.50	263	165	2	45,600	50,160
01800	18.00	263	165	2	48,800	53,680
01850	18.50	269	171	2	50,800	55,888

*Posebno označene stavke (**bold**) odnose se na robu koju imamo na lageru. Za ostali asortiman rabate i rokove isporuke dajemo na osnovu upita.

*Items given in **bold** figures refer to products on stock. Discount and delivery terms for other product assortment are given at request.

*Die separat gekennzeichneten artikel (**bold**) beziehen sich auf die Ware, die auf Lager liegt. Die Rabatte und Lieferzeiten für das restliche Sortiment geben wir auf Anfrage bekannt.

Series					BK15	BK16
	Material				HSS	HSS
	Type				RN	RN
	Point angle				118°/A	118°/A
Finish				black	b/b	
d		l ₁	l ₂	MT	price EUR	
mm		mm	mm		each	each
01900	19.00	269	171	2	50,800	55,888
01950	19.50	275	177	2	52,960	58,256
02000	20.00	275	177	2	52,960	58,256
02050	20.50	282	184	2	61,600	67,760
02100	21.00	282	184	2	61,600	67,760
02150	21.50	289	191	2	67,200	73,920
02200	22.00	289	191	2	67,200	73,920
02250	22.50	296	198	2	71,200	78,320
02300	23.00	296	198	2	76,800	84,480
02350	23.50	319	198	3	79,200	87,120
02400	24.00	327	206	3	86,400	95,040
02450	24.50	327	206	3	89,600	98,560
02500	25.00	327	206	3	84,000	92,400
02600	26.00	335	214	3	99,200	109,120
02700	27.00	343	222	3	108,800	119,680
02800	28.00	343	222	3	112,000	123,200
02900	29.00	351	230	3	121,600	133,760
03000	30.00	351	230	3	128,000	140,800
03100	31.00	360	239	3	144,000	158,400
03200	32.00	397	248	4	160,000	176,000
03300	33.00	397	248	4	180,000	198,000
03400	34.00	406	257	4	192,000	211,200
03500	35.00	406	257	4	196,000	215,600
03600	36.00	416	267	4	216,000	237,600
03700	37.00	416	267	4	224,000	246,400
03800	38.00	426	277	4	236,000	259,600
03900	39.00	426	277	4	256,000	281,600
04000	40.00	426	277	4	264,000	290,400
04100	41.00	436	287	4	288,000	316,800
04200	42.00	436	287	4	304,000	334,400
04300	43.00	447	298	4	336,000	369,600
04400	44.00	447	298	4	344,000	378,400
04500	45.00	447	298	4	368,000	404,800
04600	46.00	459	310	4	376,000	413,600
04700	47.00	459	310	4	392,000	431,200
04800	48.00	470	321	4	424,000	466,400
04900	49.00	470	321	4	436,000	479,600
05000	50.00	470	321	4	440,000	484,000

*Posebno označene stavke (**bold**) odnose se na robu koju imamo na lageru. Za ostali asortiman rabate i rokove isporuke dajemo na osnovu upita.

*Items given in **bold** figures refer to products on stock. Discount and delivery terms for other product assortment are given at request.

*Die separat gekennzeichneten artikel (**bold**) beziehen sich auf die Ware, die auf Lager liegt. Die Rabatte und Lieferzeiten für das restliche Sortiment geben wir auf Anfrage bekannt.

SPIRALNE BURGIJE KUPASTE, SPECIJALNO DUGE

EXTRA LONG TWIST DRILLS, TAPER SHANK

ÜBERLANGE SPIRALBOHRER, MORSEKEGELSCHAFT

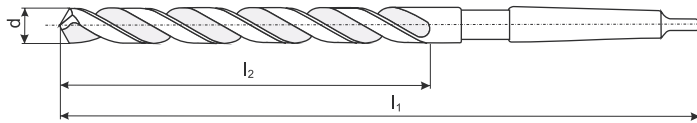

Series						BK21
	Material					HSS
Type					RN	
Point angle					118°/A	
Finish					black	
	d	l ₁	l ₂	MT	price EUR	
	mm	mm	mm		each	
00800	8.00	265	165	1	36,400	
00850	8.50	265	165	1	40,800	
00900	9.00	275	175	1	40,800	
00950	9.50	275	175	1	44,000	
01000	10.00	285	185	1	44,000	
01050	10.50	285	185	1	50,400	
01100	11.00	300	195	1	50,400	
01150	11.50	300	195	1	55,200	
01200	12.00	310	205	1	52,800	
01250	12.50	310	205	1	53,600	
01300	13.00	310	205	1	52,800	
01350	13.50	325	220	1	59,200	
01400	14.00	325	220	1	59,200	
01450	14.50	340	220	2	66,400	
01500	15.00	340	220	2	70,400	
01550	15.50	355	230	2	75,200	
01600	16.00	355	230	2	72,800	
01650	16.50	355	230	2	73,600	
01700	17.00	355	230	2	81,600	
01750	17.50	370	245	2	89,600	
01800	18.00	370	245	2	88,000	
01850	18.50	370	245	2	88,800	
01900	19.00	370	245	2	88,800	
01950	19.50	385	260	2	99,200	
02000	20.00	385	260	2	96,800	
02050	20.50	385	260	2	128,800	
02100	21.00	385	260	2	119,200	
02150	21.50	405	270	2	140,000	

*Posebno označene stavke (**bold**) odnose se na robu koju imamo na lageru. Za ostali asortiman rabate i rokove isporuke dajemo na osnovu upita.

*Items given in **bold** figures refer to products on stock. Discount and delivery terms for other product assortment are given at request.

*Die separat gekennzeichneten artikel (**bold**) beziehen sich auf die Ware, die auf Lager liegt. Die Rabatte und Lieferzeiten für das restliche Sortiment geben wir auf Anfrage bekannt.

Series					BK21
	Material				HSS
	Type				RN
	Point angle				118°/A
Finish				black	
	d	l ₁	l ₂	MT	price EUR
	mm	mm	mm		each
02200	22.00	405	270	2	126,400
02250	22.50	405	270	2	152,800
02300	23.00	405	270	2	144,800
02350	23.50	425	270	3	180,800
02400	24.00	440	290	3	164,800
02450	24.50	440	290	3	192,000
02500	25.00	440	290	3	174,400
02550	25.50	440	290	3	208,000
02600	26.00	440	290	3	187,200
02650	26.50	440	290	3	220,800
02700	27.00	460	305	3	193,600
02750	27.50	460	305	3	228,800
02800	28.00	460	305	3	208,000
02850	28.50	460	305	3	244,800
02900	29.00	460	305	3	220,800
02950	29.50	460	305	3	256,000
03000	30.00	460	305	3	227,200
03100	31.00	480	320	3	275,200
03200	32.00	505	320	4	281,600
03300	33.00	505	320	4	294,400
03400	34.00	530	340	4	318,400
03500	35.00	530	340	4	323,200
03600	36.00	530	340	4	344,000
03700	37.00	530	340	4	347,200
03800	38.00	555	360	4	368,000
03900	39.00	555	360	4	387,200
04000	40.00	555	360	4	388,800
04100	41.00	555	360	4	416,000
04200	42.00	555	360	4	424,000
04300	43.00	585	385	4	464,000
04400	44.00	585	385	4	464,000
04500	45.00	585	385	4	488,000
04600	46.00	585	385	4	512,000
04700	47.00	585	385	4	536,000
04800	48.00	605	405	4	584,000
04900	49.00	605	405	4	608,000
05000	50.00	605	405	4	600,000

*Posebno označene stavke (**bold**) odnose se na robu koju imamo na lageru. Za ostali asortiman rabate i rokove isporuke dajemo na osnovu upita.

*Items given in **bold** figures refer to products on stock. Discount and delivery terms for other product assortment are given at request.

*Die separat gekennzeichneten artikel (**bold**) beziehen sich auf die Ware, die auf Lager liegt. Die Rabatte und Lieferzeiten für das restliche Sortiment geben wir auf Anfrage bekannt.

SPIRALNE BURGIJE KUPASTE, SPECIJALNE DUGE

EXTRA LONG TWIST DRILLS, TAPER SHANK

ÜBERLANGE SPIRALBOHRER, MORSEKEGELSCHAFT

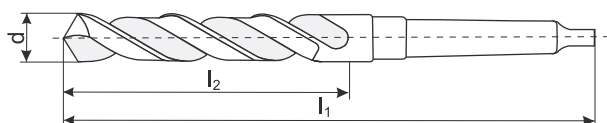

Series	Material					BK25
	Type					HSS
Point angle					RN	
Finish					118°/A	
					black	
	d	l ₁	l ₂	MT	price EUR	
	mm	mm	mm		each	
00800	8.00	330	210	1	52,000	
00850	8.50	330	210	1	56,800	
00900	9.00	345	220	1	64,000	
00950	9.50	345	220	1	64,000	
01000	10.00	360	235	1	63,200	
01050	10.50	360	235	1	72,800	
01100	11.00	375	250	1	68,000	
01150	11.50	375	250	1	72,800	
01200	12.00	395	260	1	76,800	
01250	12.50	395	260	1	81,600	
01300	13.00	395	260	1	78,400	
01350	13.50	410	275	1	85,600	
01400	14.00	410	275	1	88,000	
01450	14.50	425	275	2	92,000	
01500	15.00	445	295	2	94,400	
01550	15.50	445	295	2	96,800	
01600	16.00	445	295	2	96,800	
01650	16.50	445	295	2	104,000	
01700	17.00	445	295	2	103,200	
01750	17.50	465	310	2	112,000	
01800	18.00	465	310	2	113,600	
01850	18.50	465	310	2	122,400	
01900	19.00	465	310	2	124,000	
01950	19.50	490	325	2	136,800	
02000	20.00	490	325	2	133,600	
02050	20.50	490	325	2	150,400	
02100	21.00	490	325	2	146,400	
02150	21.50	515	345	2	176,000	

*Posebno označene stavke (**bold**) odnose se na robu koju imamo na lageru. Za ostali asortiman rabate i rokove isporuke dajemo na osnovu upita.

*Items given in **bold** figures refer to products on stock. Discount and delivery terms for other product assortment are given at request.

*Die separat gekennzeichneten artikel (**bold**) beziehen sich auf die Ware, die auf Lager liegt. Die Rabatte und Lieferzeiten für das restliche Sortiment geben wir auf Anfrage bekannt.

Series	BK25				
	Material				HSS
	Type				RN
Point angle				118°/A	
Finish				black	
	d	l ₁	l ₂	MT	price EUR
	mm	mm	mm		each
02200	22.00	515	345	2	172,800
02250	22.50	515	345	2	184,000
02300	23.00	515	345	2	177,600
02350	23.50	535	345	3	217,600
02400	24.00	555	365	3	206,400
02450	24.50	555	365	3	235,200
02500	25.00	555	365	3	212,800
02550	25.50	555	365	3	275,200
02600	26.00	555	365	3	248,000
02650	26.50	555	365	3	294,400
02700	27.00	580	385	3	264,000
02750	27.50	580	385	3	313,600
02800	28.00	580	385	3	280,000
02850	28.50	580	385	3	324,800
02900	29.00	580	385	3	294,400
02950	29.50	580	385	3	344,000
03000	30.00	580	385	3	304,000
03100	31.00	610	410	3	352,000
03200	32.00	635	410	4	358,400
03300	33.00	635	410	4	369,600
03400	34.00	665	430	4	400,000
03500	35.00	665	430	4	400,000
03600	36.00	665	430	4	424,000
03700	37.00	665	430	4	480,000
03800	38.00	695	460	4	480,000
03900	39.00	695	460	4	488,000
04000	40.00	695	460	4	496,000
04100	41.00	695	460	4	552,000
04200	42.00	695	430	4	584,000
04300	43.00	735	490	4	640,000
04400	44.00	735	490	4	712,000
04500	45.00	735	490	4	664,000
04600	46.00	735	490	4	680,000
04700	47.00	695	490	4	704,000
04800	48.00	765	510	4	744,000
04900	49.00	765	510	4	784,000
05000	50.00	765	510	4	768,000

*Posebno označene stavke (**bold**) odnose se na robu koju imamo na lageru. Za ostali asortiman rabate i rokove isporuke dajemo na osnovu upita.

*Items given in **bold** figures refer to products on stock. Discount and delivery terms for other product assortment are given at request.

*Die separat gekennzeichneten artikel (**bold**) beziehen sich auf die Ware, die auf Lager liegt. Die Rabatte und Lieferzeiten für das restliche Sortiment geben wir auf Anfrage bekannt.

SPIRALNE BURGIJE STEPENASTE, VALJKASTE

SUBLAND DRILLS WITH STRAIGHT SHANK

MEHRFASENSTUFENBOHRER MIT ZYLINDERSCHAFT



DIN 8374 / 90°

Series							BV81	
							Material	HSS
							Type	RN
							Point angle	118°
							Finish	black
M		d ₂	d ₁	l ₁	l ₂	l ₃	price EUR	
		mm	mm	mm	mm	mm	each	
M0300	3	6.00	3.2	93	57	9	24,320	
M0400	4	8.00	4.3	117	75	11	28,160	
M0500	5	10.00	5.3	133	87	13	35,200	
M0600	6	11.00	6.4	142	94	15	40,960	
M0800	8	15.00	8.4	169	114	19	67,200	
M1000	10	19.00	10.5	198	135	23	103,040	

DIN 8376 / 180°

Series							BV83	
							Material	HSS
							Type	RN
							Point angle	118°
							Finish	black
M		d ₂	d ₁	l ₁	l ₂	l ₃	price EUR	
		mm	mm	mm	mm	mm	each	
M0300	3	6	3.4	93	57	9	21,120	
M0400	4	8	4.5	117	75	11	24,960	
M0500	5	10	5.5	133	87	13	30,080	
M0600	6	11	6.6	142	94	15	35,200	
M0800	8	15	9	168	114	19	44,800	
M1000	10	18	11	191	130	23	62,720	

DIN 8378 / 90°

Series							BV85	
							Material	HSS
							Type	RN
							Point angle	118°
							Finish	black
M		d ₂	d ₁	l ₁	l ₂	l ₃	price EUR	
		mm	mm	mm	mm	mm	each	
M0300	3	3.4	2.5	70	39	8.8	19,200	
M0400	4	4.5	3.3	80	47	11.4	20,480	
M0500	5	5.5	4.2	93	57	13.6	21,120	
M0600	6	6.6	5	101	63	16.5	24,320	
M0800	8	9.0	6.8	125	81	21	27,520	
M1000	10	11	8.5	142	94	25.5	35,840	
M1200	12	13.5	10.2	160	108	30	46,720	

*Posebno označene stavke (**bold**) odnose se na robu koju imamo na lageru. Za ostali asortiman rabate i rokove isporuke dajemo na osnovu upita.

*Items given in **bold** figures refer to products on stock. Discount and delivery terms for other product assortment are given at request.

*Die separat gekennzeichneten artikel (**bold**) beziehen sich auf die Ware, die auf Lager liegt. Die Rabatte und Lieferzeiten für das restliche Sortiment geben wir auf Anfrage bekannt.

SPIRALNE BURGIJE STEPENASTE, KUPASTE

SUBLAND DRILLS WITH MORSE TAPER SHANK

MEHRFASENSTUFENBOHRER MIT MORSEKEGELSCHAFT

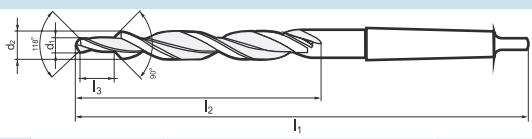

DIN 8375 / 90°

Series							BK81	
							Material	HSS
							Type	RN
							Point angle	118°
							Finish	black
							price EUR	
M	d ₂	d ₁	l ₁	l ₂	l ₃	MT	each	
	mm	mm	mm	mm	mm			
M0500	5	11.0	5.5	175	94	1	50,560	
M0600	6	13.0	6.6	182	101	1	67,840	
M0800	8	17.2	9.0	228	130	2	82,560	
M1000	10	21.5	11.0	248	150	2	118,400	

DIN 8377 / 90°

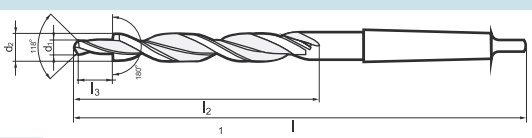
Series							BK83	
							Material	HSS
							Type	RN
							Point angle	118°
							Finish	black
							price EUR	
M	d ₂	d ₁	l ₁	l ₂	l ₃	MT	each	
	mm	mm	mm	mm	mm			
M0500	5	10	5.5	168	87	1	44,160	
M0600	6	11	6.6	175	94	1	45,440	
M0800	8	15	9	212	114	2	60,160	
M1000	10	18	11	228	130	2	80,000	
M1200	12	20	13.5	238	140	2	96,640	
M1400	14	24	15.5	281	160	3	121,600	
M1600	16	26	17.5	286	165	3	144,000	
M1800	18	30	20	296	175	3	166,400	
M2000	20	33	22	334	185	4	193,920	

DIN 8379 / 90°

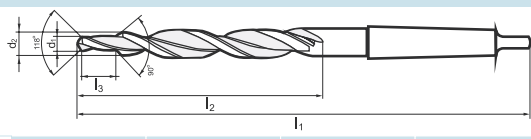
Series							BK85	
							Material	HSS
							Type	RN
							Point angle	118°
							Finish	black
							price EUR	
M	d ₂	d ₁	l ₁	l ₂	l ₃	MT	each	
	mm	mm	mm	mm	mm			
M0800	8	9	6.8	162	81	1	44,160	
M1000	10	11	8.5	175	94	1	50,560	
M1200	12	13.5	10.2	189	108	1	60,160	
M1400	14	15.5	12	218	120	2	72,960	
M1600	16	17.5	14	228	130	2	87,040	
M1800	18	20	15.5	238	140	2	110,720	
M2000	20	22	17.5	248	150	2	117,120	

*Posebno označene stavke (**bold**) odnose se na robu koju imamo na lageru. Za ostali asortiman rabate i rokove isporuke dajemo na osnovu upita.

*Items given in **bold** figures refer to products on stock. Discount and delivery terms for other product assortment are given at request.

*Die separat gekennzeichneten artikel (**bold**) beziehen sich auf die Ware, die auf Lager liegt. Die Rabatte und Lieferzeiten für das restliche Sortiment geben wir auf Anfrage bekannt.

ZABUŠIVAČI 60°

CENTER DRILLS 60°

ZENTRIERBOHRER 60°

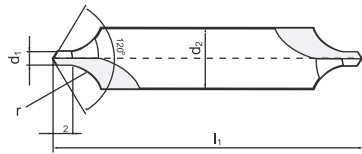

Series	Material						BZ01	BZ02	BZ03	BZ04	BZ05	BZ06
	Type						A/R	A/L	A/flat	R/R	R/L	R /flat
	Point angle						120°	120°	120°	120°	120°	120°
Finish						bright	bright	bright	bright	bright	bright	bright
d ₁		l ₁		l ₂		d ₂		price EUR				
mm		mm		mm		mm		each	each	each	each	each
00050	0.50	25.0	0.8	3.15	2,960	3,850	3,700	2,960	3,850	3,700		
00080	0.80	25.0	1.1	3.15	2,880	3,740	3,600	2,880	3,740	3,600		
00100	1.00	31.5	1.3	3.15	2,560	3,330	3,200	2,560	3,330	3,200		
00125	1.25	31.5	1.6	3.15	2,530	3,290	3,160	2,530	3,290	3,160		
00160	1.60	35.5	2.0	4.00	2,400	3,120	3,000	2,400	3,120	3,000		
00200	2.00	40.0	2.5	5.00	2,660	3,450	3,320	2,660	3,450	3,320		
00250	2.50	45.0	3.1	6.30	2,880	3,740	3,600	2,880	3,740	3,600		
00315	3.15	50.0	3.9	8.00	3,360	4,370	4,200	3,360	4,370	4,200		
00400	4.00	56.0	5.0	10.00	6,590	8,560	8,240	6,590	8,560	8,240		
00500	5.00	63.0	6.3	12.50	9,000	11,700	11,250	9,000	11,700	11,250		
00630	6.30	71.0	8.0	16.00	13,680	17,780	17,100	13,680				17,100
00800	8.00	80.0	10.1	20.00	21,240		26,550	21,240				26,550
01000	10.00	100.0	12.8	25.00	42,480		53,100	42,480				53,100
01250	12.50	125.0	16.5	31.50	63,360		79,200	63,360				79,200

ZABUŠIVAČI 60°/120°

CENTER DRILLS 60°/120°

ZENTRIERBOHRER 60°/120°

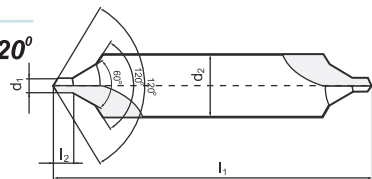































Series	Material						BZ11	BZ12	BZ13	
	Type						B/R	B/L	B/flat	
	Point angle						120°	120°	120°	
Finish						bright	bright	bright		
d ₁		l ₁		l ₂		d ₂		price EUR		
mm		mm		mm		mm		each	each	each
00100	1.00	35.5	1.3	4.0	3,840	4,990	4,800			
00125	1.25	40.0	1.6	5.0	3,840	4,990	4,800			
00160	1.60	45.0	2.0	6.3	4,160	5,410	5,200			
00200	2.00	50.0	2.5	8.0	4,480	5,820	5,600			
00250	2.50	56.0	3.1	10.0	5,440	7,070	6,800			
00315	3.15	60.0	3.9	11.2	6,720	8,740	8,400			
00400	4.00	67.0	5.0	14.0	11,160	14,510	13,950			
00500	5.00	75.0	6.3	18.0	14,040	18,250	17,550			
00630	6.30	80.0	8.0	20.0	20,160	26,210	25,200			
00800	8.00	100.0	10.1	25.0	39,600	51,480	49,500			
01000	10.00	125.0	12.8	31.5	78,480	102,020	98,100			

*Posebno označene stavke (**bold**) odnose se na robu koju imamo na lageru. Za ostali asortiman rabate i rokove isporuke dajemo na osnovu upita.

*Items given in **bold** figures refer to products on stock. Discount and delivery terms for other product assortment are given at request.

*Die separat gekennzeichneten artikel (**bold**) beziehen sich auf die Ware, die auf Lager liegt. Die Rabatte und Lieferzeiten für das restliche Sortiment geben wir auf Anfrage bekannt.

SADRŽAJ - CONTENTS - INHALTSVERZEICHNIS

DIN	THREAD	MATERIAL	SERIES		PAGE
352	M	HSS	NR01-NR05		3N
	UNC	HSS	NR11-NR14		4N
	BSW	HSS	NR16-NR19		5N
2181	Mf	HSS	NR21-NR24		6N
	UNF	HSS	NR27-NR29		8N
5157	G	HSS	NR31-NR34		9N
40432	Pg	HSS	NR41-NR44		10N
	UN	HSS	NR45-NR48		
371	M	HSS/HSS Co	NM01-NM08		11N
	M	HSS/HSS Co	NM11-NM16		12N
	UNC	HSS/HSS Co	NM41-NM46		13N
	UNF	HSS/HSS Co	NM71-NM76		
376	M	HSS/HSS Co	NM21-NM27		14N
	M	HSS/HSS Co	NM31-NM36		15N
	UNC	HSS/HSS Co	NM51-NM56		16N
2182	BSW	HSS	NM47-NM50		17N
2183	BSW	HSS	NM57-NM60		
374	Mf	HSS/HSS Co	NM61-NM66		18N
	Mf	HSS/HSS Co	NM67-NM70		20N
5156	UNF	HSS/HSS Co	NM81-NM86		21N
	G	HSS	NM87-NM90		
357	M	HSS/HSS Co	NM91-NM92		22N
	NPT	HSS/HSS Co	NC01-NC04		23N
	BSPT	HSS/HSS Co	NC08-NC09		
(223)	M/UNC	HSS	NN01-02-NN05-06		24N
	Mf	HSS	NN03-NN04		25N
	UNF/BSW	HSS	NN07-NN10		26N
	BSF	HSS	NN11-NN12		27N
	BSPT	HSS	NN13-NN14		28N
	Pg	HSS	NN15-NN16		27N
	NPT	HSS	NN21-NN22		28N
	NPTF	HSS	NN23-NN24		

GREŠKE I PROPUSTI MOGUĆI

ERRORS AND OMISSIONS EXCEPTED

RUČNI UREZNICI, TROSTEPENI, M NAVOJ

HAND TAPS, M COARSE THREAD

HANDGEWINDEBOHRER, M REGELGEWINDE

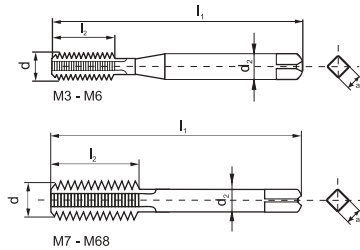

Series							NR01	NR02	NR03	NR04	NR05	
	Material						HSS	HSS	HSS	HSS	HSS	
	Type						1st	2nd	finishing	set (3pcs)	B	
	Finish						ground	ground	ground	ground	ground	
		d	P	l ₁	l ₂ max	d ₂	a	price EUR				
		mm	mm	mm	mm	mm	mm	each	each	each	set	each
M0016	M 1,6	0,35	32	8	2,5	2,1	4,308	4,308	5,170	13,786	6,720	
M0017	1,7	0,35	32	8	2,5	2,1	4,308	4,308	5,170	13,786	6,720	
M0018	1,8	0,35	32	8	2,5	2,1	4,308	4,308	5,170	13,786	6,720	
M0020	2	0,4	36	8	2,8	2,1	3,600	3,600	4,320	11,520	5,616	
M0022	2,2	0,45	36	9	2,8	2,1	3,768	3,768	4,522	12,058	5,878	
M0023	2,3	0,4	36	9	2,8	2,1	3,768	3,768	4,522	12,058	5,878	
M0025	2,5	0,45	40	9	2,8	2,1	3,132	3,132	3,758	10,022	4,886	
M0025	2,6	0,45	40	9	2,8	2,1	3,132	3,132	3,758	10,022	4,886	
M0030	3	0,5	40	11	3,5	2,7	2,556	2,556	3,067	8,179	3,987	
M0035	3,5	0,6	45	12	4,0	3,0	2,964	2,964	3,557	9,485	4,624	
M0040	4	0,7	45	13	4,5	3,4	2,556	2,556	3,067	8,179	3,987	
M0045	4,5	0,75	50	16	6,0	4,9	3,828	3,828	4,594	12,250	5,972	
M0050	5	0,8	50	16	6,0	4,9	2,652	2,652	3,182	8,486	4,137	
M0060	6	1,0	56	19	6,0	4,9	2,748	2,748	3,298	8,794	4,287	
M0070	7	1,0	56	19	6,0	4,9	3,600	3,600	4,320	11,520	5,616	
M0080	8	1,25	63	22	6,0	4,9	3,060	3,060	3,672	9,792	4,774	
M0090	9	1,25	63	22	7,0	5,5	4,632	4,632	5,558	14,822	7,226	
M0100	10	1,5	70	24	7,0	5,5	3,888	3,888	4,666	12,442	6,065	
M0110	11	1,5	70	24	8,0	6,2	8,720	8,720	10,464	27,904	13,603	
M0120	12	1,75	75	28	9,0	7,0	6,640	6,640	7,968	21,248	10,358	
M0140	14	2,0	80	30	11,0	9,0	9,024	9,024	10,829	28,877	14,077	
M0160	16	2,0	80	32	12,0	9,0	10,896	10,896	13,075	34,867	16,998	
M0180	18	2,5	95	34	14,0	11,0	15,872	15,872	19,046	50,790	24,760	
M0200	20	2,5	95	34	16,0	12,0	16,960	16,960	20,352	54,272	26,458	
M0220	22	2,5	100	34	18,0	14,5	25,080	25,080	30,096	80,256	39,125	
M0240	24	3,0	110	38	18,0	14,5	28,220	28,220	33,864	90,304	44,023	
M0270	27	3,0	110	38	20,0	16,0	37,060	37,060	44,472	118,592	57,814	
M0300	30	3,5	125	45	22,0	18,0	47,320	47,320	56,784	151,424	73,819	
M0330	33	3,5	125	50	25,0	20,0	58,720	58,720	70,464	187,904	91,603	
M0360	36	4,0	150	56	28,0	22,0	68,440	68,440	82,128	219,008	106,766	
M0390	39	4,0	150	60	32,0	24,0	88,360	88,360	106,032	282,752	137,842	
M0420	42	4,5	150	60	32,0	24,0	98,640	98,640	118,368	315,648	153,878	
M0450	45	4,5	160	65	36,0	29,0	114,020	114,020	136,824	364,864	177,871	
M0480	48	5,0	180	70	36,0	29,0	163,040	163,040	195,648	521,728	254,342	
M0520	52	5,0	180	70	40,0	32,0	172,460	172,460	206,952	551,872	269,038	
M0560	56	5,5	180	70	40,0	32,0	192,700	192,700	231,240	616,640	300,612	
M0600	60	5,5	200	75	45,0	35,0	245,140	245,140	294,168	784,448	382,418	
M0640	64	6,0	220	80	50,0	39,0	263,400	263,400	316,080	842,880	410,904	
M0680	68	6,0	220	80	50,0	39,0	293,040	293,040	351,648	937,728	457,142	

*Posebno označene stavke (**bold**) odnose se na robu koju imamo na lageru. Za ostali asortiman rabate i rokove isporuke dajemo na osnovu upita.
 *Items given in **bold** figures refer to products on stock. Discount and delivery terms for other product assortment are given at request.
 *Die separat gekennzeichneten artikel (**bold**) beziehen sich auf die Ware, die auf Lager liegt. Die Rabatte und Lieferzeiten für das restliche Sortiment geben wir auf Anfrage bekannt.

RUČNI UREZNICI, TROSTEPENI, UNC NAVOJ

HAND TAPS, UNC THREAD

HANDGEWINDEBOHRER, UNC GEWINDE

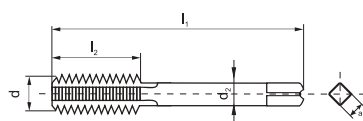

Series								NR11	NR12	NR13	NR14
	Material							HSS	HSS	HSS	HSS
	Type							1st	2nd	finishing	set (3pcs)
Finish							ground	ground	ground	ground	
d		P	l ₁	l _{2max}	d ₂	a	price EUR				
inch	mm	inch	mm	mm	mm	mm	each	each	each	set	
N0001	No 1	1,854	64	36	8	2,8	2,1	4,74	4,74	5,69	15,17
N0002	2	2,184	56	36	9	2,8	2,1	4,74	4,74	5,69	15,17
N0003	3	2,515	48	40	9	2,8	2,1	4,01	4,01	4,81	12,83
N0004	4	2,845	40	40	11	3,5	2,7	3,65	3,65	4,38	11,67
N0005	5	3,175	40	40	11	3,5	2,7	3,65	3,65	4,38	11,67
N0006	6	3,505	32	45	12	4,0	3,0	3,65	3,65	4,38	11,67
N0008	8	4,166	32	45	13	4,5	3,4	3,65	3,65	4,38	11,67
N0010	10	4,826	24	50	16	6,0	4,9	4,01	4,01	4,81	12,83
N0012	12	5,486	24	56	17	6,0	4,9	4,01	4,01	4,81	12,83
I0016	1/4	6,350	20	56	19	6,0	4,9	4,01	4,01	4,81	12,83
I0020	5/16	7,938	18	63	22	6,0	4,9	4,38	4,38	5,26	14,02
I0024	3/8	9,525	16	70	24	7,0	5,5	5,11	5,11	6,13	16,36
I0028	7/16	11,113	14	70	24	8,0	6,2	7,78	7,78	9,33	24,88
I0032	1/2	12,700	13	75	28	9,0	7,0	9,25	9,25	11,10	29,59
I0036	9/16	14,288	12	80	30	11,0	9,0	12,64	12,64	15,17	40,45
I0040	5/8	15,875	11	80	32	12,0	9,0	12,64	12,64	15,17	40,45
I0048	3/4	19,050	10	95	34	14,0	11,0	17,02	17,02	20,43	54,48
I0056	7/8	22,225	9	100	34	18,0	14,5	21,89	21,89	26,27	70,04
I1000	1"	25,400	8	110	38	18,0	14,5	35,26	35,26	42,31	112,83
I1008	1 1/8	28,575	7	125	45	22,0	18,0	48,64	48,64	58,37	155,65
I1016	1 1/4	31,750	7	125	45	25,0	20,0	69,92	69,92	83,90	223,74
I1024	1 3/8	34,925	6	150	56	28,0	22,0	103,36	103,36	124,03	330,75
I1032	1 1/2	38,100	6	150	56	32,0	24,0	115,52	115,52	138,62	369,66
I1048	1 3/4	44,450	5	160	65	36,0	29,0	136,80	136,80	164,16	437,76
I2000	2"	50,800	4 1/2	180	70	40,0	32,0	182,40	182,40	218,88	583,68

*Posebno označene stavke (**bold**) odnose se na robu koju imamo na lageru. Za ostali asortiman rabate i rokove isporuke dajemo na osnovu upita.

*Items given in **bold** figures refer to products on stock. Discount and delivery terms for other product assortment are given at request.

*Die separat gekennzeichneten artikel (**bold**) beziehen sich auf die Ware, die auf Lager liegt. Die Rabatte und Lieferzeiten für das restliche Sortiment geben wir auf Anfrage bekannt.

**RUČNI UREZNICI, TROSTEPENI,
WHITWORTH (BSW) NAVOJ**

HAND TAPS, WHITWORTH (BSW) THREAD

**HANDGEWINDEBOHRER,
WHITWORTH (BSW) GEWINDE**

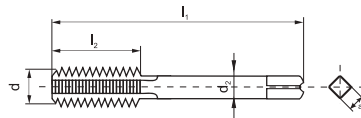

Series								NR16	NR17	NR18	NR19
	Material							HSS	HSS	HSS	HSS
Type							1st	2nd	finishing	set (3pcs)	
Finish							ground	ground	ground	ground	
d		P	l ₁	l _{2max}	d ₂	a	price EUR				
inch	mm	inch	mm	mm	mm	mm	each	each	each	set	
W0004	W1/16"	1,587	60	32	8	2,5	2,1	4,980	4,980	5,976	15,936
W0006	3/32	2,381	48	40	9	2,8	2,1	4,980	4,980	5,976	15,936
W0008	1/8	3,175	40	40	11	3,5	2,7	4,212	4,212	5,054	13,478
W0010	5/32	3,968	32	45	13	4,5	3,4	3,828	3,828	4,594	12,250
W0012	3/16	4,762	24	50	16	6,0	4,9	3,828	3,828	4,594	12,250
W0014	7/32	5,556	24	56	17	6,0	4,9	4,212	4,212	5,054	13,478
W0016	1/4	6,350	20	56	19	6,0	4,9	4,212	4,212	5,054	13,478
W0020	5/16	7,938	18	63	22	6,0	4,9	4,596	4,596	5,515	14,707
W0024	3/8	9,525	16	70	24	7,0	5,5	5,364	5,364	6,437	17,165
W0028	7/16	11,113	14	70	24	8,0	6,2	8,176	8,176	9,811	26,163
W0032	1/2	12,700	12	75	28	9,0	7,0	9,712	9,712	11,654	31,078
W0036	9/16	14,288	12	80	30	11,0	9,0	13,280	13,280	15,936	42,496
W0040	5/8	15,875	11	80	32	12,0	9,0	13,280	13,280	15,936	42,496
W0048	3/4	19,050	10	95	34	14,0	11,0	17,872	17,872	21,446	57,190
W0056	7/8	22,225	9	100	34	18,0	14,5	22,976	22,976	27,571	73,523
W1000	1"	25,400	8	110	38	18,0	14,5	29,616	29,616	35,539	94,771
W1008	1 1/8	28,575	7	125	45	22,0	18,0	40,864	40,864	49,037	130,765
W1016	1 1/4	31,750	7	125	45	22,0	18,0	58,736	58,736	70,483	187,955
W1024	1 3/8	34,925	6	150	56	28,0	22,0	86,816	86,816	104,179	277,811
W1032	1 1/2	38,100	6	150	56	28,0	22,0	97,040	97,040	116,448	310,528
W1040	1 5/8	41,275	5	150	60	32,0	24,0	106,208	106,208	127,450	339,866
W1048	1 3/4	44,450	5	160	65	36,0	29,0	114,912	114,912	137,894	367,718
W1056	1 7/8	47,625	4 1/2	180	70	36,0	29,0	138,272	138,272	165,926	442,470
W2000	2"	50,800	4 1/2	180	70	40,0	32,0	153,216	153,216	183,859	490,291

*Posebno označene stavke (**bold**) odnose se na robu koju imamo na lageru. Za ostali asortiman rabate i rokove isporuke dajemo na osnovu upita.

*Items given in **bold** figures refer to products on stock. Discount and delivery terms for other product assortment are given at request.

*Die separat gekennzeichneten artikel (**bold**) beziehen sich auf die Ware, die auf Lager liegt. Die Rabatte und Lieferzeiten für das restliche Sortiment geben wir auf Anfrage bekannt.

RUČNI UREZNICI, DVOSTEPENI, Mf FINI NAVOJ

HAND TAPS, Mf FINE COARSE THREAD

HANDGEWINDEBOHRER, Mf FEINGEWINDE

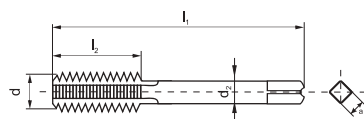

Series							NR21	NR23	NR24
	Material						HSS	HSS	HSS
	Type						1st	finishing	set (2pcs)
	Finish						ground	ground	ground
	d	P	l ₁	l _{2max}	d ₂	a	price EUR		
	mm	mm	mm	mm	mm	mm	each	each	set
020025	M 2	0,25	36	8	2,8	2,1	5,916	6,508	12,424
022025	2,2	0,25	36	9	2,8	2,1	5,760	6,336	12,096
025035	2,5	0,35	40	9	2,8	2,1	5,652	6,217	11,869
030035	3	0,35	40	8	3,5	2,7	5,652	6,217	11,869
035035	3,5	0,35	45	9	4,0	3,0	4,704	5,174	9,878
040035	4	0,35	45	10	4,5	3,4	6,024	6,626	12,650
040050	4	0,5	45	10	4,5	3,4	4,632	5,095	9,727
050035	5	0,35	50	12	6,0	4,9	6,492	7,141	13,633
050050	5	0,5	50	12	6,0	4,9	4,956	5,452	10,408
060050	6	0,5	56	14	6,0	4,9	5,292	5,821	11,113
060075	6	0,75	56	14	6,0	4,9	5,184	5,702	10,886
070075	7	0,75	56	14	6,0	4,9	5,952	6,547	12,499
080075	8	0,75	56	18	6,0	4,9	6,096	6,706	12,802
080100	8	1,0	63	22	6,0	4,9	5,184	5,702	10,886
090100	9	1,0	63	22	7,0	5,5	7,884	8,672	16,556
100050	10	0,5	63	20	7,0	5,5	9,516	10,468	19,984
100075	10	0,75	63	20	7,0	5,5	8,100	8,910	17,010
100100	10	1,0	63	20	7,0	5,5	5,532	6,085	11,617
100125	10	1,25	70	24	7,0	5,5	6,864	7,550	14,414
120100	12	1,0	70	22	9,0	7,0	7,574	8,331	15,905
120125	12	1,25	70	22	9,0	7,0	9,618	10,580	20,198
120150	12	1,5	70	22	9,0	7,0	7,322	8,054	15,376
130100	13	1,0	70	22	11,0	9,0	13,748	15,123	28,871
140100	14	1,0	70	22	11,0	9,0	10,850	11,935	22,785
140125	14	1,25	70	22	11,0	9,0	10,556	11,612	22,168
140150	14	1,5	70	22	11,0	9,0	9,156	10,072	19,228
150100	15	1,0	70	22	12,0	9,0	12,558	13,814	26,372
150150	15	1,5	70	22	12,0	9,0	11,060	12,166	23,226
160100	16	1,0	70	22	12,0	9,0	11,914	13,105	25,019
160150	16	1,5	70	22	12,0	9,0	9,786	10,765	20,551
180100	18	1,0	80	22	14,0	11,0	15,750	17,325	33,075
180150	18	1,5	80	22	14,0	11,0	12,768	14,045	26,813
180200	18	2,0	80	22	14,0	11,0	16,170	17,787	33,957
200100	20	1,0	80	22	16,0	12,0	17,444	19,188	36,632
200150	20	1,5	80	22	16,0	12,0	14,042	15,446	29,488
200200	20	2,0	80	22	16,0	12,0	17,444	19,188	36,632

*Posebno označene stavke (**bold**) odnose se na robu koju imamo na lageru. Za ostali asortiman rabate i rokove isporuke dajemo na osnovu upita.

*Items given in **bold** figures refer to products on stock. Discount and delivery terms for other product assortment are given at request.

*Die separat gekennzeichneten artikel (**bold**) beziehen sich auf die Ware, die auf Lager liegt. Die Rabatte und Lieferzeiten für das restliche Sortiment geben wir auf Anfrage bekannt.

Series							NR21	NR23	NR24
	Material						HSS	HSS	HSS
	Type						1st	finishing	set (2pcs)
	Finish						ground	ground	ground
	d	P	l ₁	l ₂ max	d ₂	a	price EUR		
	mm	mm	mm	mm	mm	mm	each	each	set
220100	22	1,0	80	22	18,0	14,5	23,344	25,678	49,022
220150	22	1,5	80	22	18,0	14,5	20,432	22,475	42,907
220200	22	2,0	80	22	18,0	14,5	23,344	25,678	49,022
240100	24	1,0	90	22	18,0	14,5	27,728	30,501	58,229
240150	24	1,5	90	22	18,0	14,5	23,344	25,678	49,022
240200	24	2,0	90	22	18,0	14,5	24,320	26,752	51,072
260100	26	1,0	90	22	18,0	14,5	34,048	37,453	71,501
260150	26	1,5	90	22	18,0	14,5	30,640	33,704	64,344
280100	28	1,0	90	22	20,0	16,0	46,688	51,357	98,045
280150	28	1,5	90	22	20,0	16,0	32,096	35,306	67,402
280200	28	2,0	90	22	20,0	16,0	40,864	44,950	85,814
300100	30	1,0	90	22	22,0	18,0	41,824	46,006	87,830
300150	30	1,5	90	22	22,0	18,0	36,960	40,656	77,616
300200	30	2,0	90	22	22,0	18,0	40,864	44,950	85,814
320150	32	1,5	90	22	22,0	18,0	41,824	46,006	87,830
330150	33	1,5	100	25	25,0	20,0	46,672	51,339	98,011
330200	33	2,0	100	25	25,0	20,0	53,488	58,837	112,325
340150	34	1,5	100	25	28,0	22,0	48,624	53,486	102,110
350150	35	1,5	100	25	28,0	22,0	53,488	58,837	112,325
360150	36	1,5	100	25	28,0	22,0	55,920	61,512	117,432
360200	36	2,0	125	40	28,0	22,0	60,800	66,880	127,680
360300	36	3,0	125	40	28,0	22,0	63,200	69,520	132,720
380150	38	1,5	100	25	28,0	22,0	60,800	66,880	127,680
390200	39	2,0	125	40	32,0	24,0	79,280	87,208	166,488
390300	39	3,0	125	40	32,0	24,0	86,400	95,040	181,440
400150	40	1,5	110	25	32,0	24,0	70,992	78,091	149,083
400200	40	2,0	125	40	32,0	24,0	77,792	85,571	163,363
420150	42	1,5	110	25	32,0	24,0	82,176	90,394	172,570
420200	42	2,0	125	40	32,0	24,0	77,792	85,571	163,363
420300	42	3,0	125	40	32,0	24,0	87,552	96,307	183,859
450150	45	1,5	110	25	36,0	29,0	90,432	99,475	189,907
450200	45	2,0	125	40	36,0	29,0	96,304	105,934	202,238
450300	45	3,0	125	40	36,0	29,0	97,248	106,973	204,221
480150	48	1,5	140	40	36,0	29,0	100,160	110,176	210,336
480200	48	2,0	140	40	36,0	29,0	107,952	118,747	226,699
480300	48	3,0	140	40	36,0	29,0	111,840	123,024	234,864
500150	50	1,5	140	40	36,0	29,0	109,408	120,349	229,757
500200	50	2,0	140	40	36,0	29,0	116,736	128,410	245,146
500300	50	3,0	140	40	36,0	29,0	129,824	142,806	272,630
520150	52	1,5	140	40	40,0	32,0	116,704	128,374	245,078
520200	52	2,0	140	40	40,0	32,0	119,648	131,613	251,261
520300	52	3,0	140	40	40,0	32,0	129,536	142,490	272,026

*Posebno označene stavke (**bold**) odnose se na robu koju imamo na lageru. Za ostali asortiman rabate i rokove isporuke dajemo na osnovu upita.

*Items given in **bold** figures refer to products on stock. Discount and delivery terms for other product assortment are given at request.

*Die separat gekennzeichneten artikel (**bold**) beziehen sich auf die Ware, die auf Lager liegt. Die Rabatte und Lieferzeiten für das restliche Sortiment geben wir auf Anfrage bekannt.

RUČNI UREZNICI, DVOSTEPENI, UNF NAVOJ

HAND TAPS, UNF THREAD

HANDGEWINDEBOHRER, UNF GEWINDE

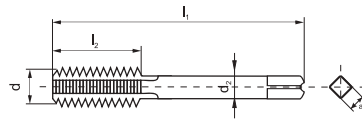

Series								NR27	NR28	NR29
	Material							HSS	HSS	HSS
	Type							1st ground	finishing ground	set (2pcs) ground
Finish										
d		P	l ₁	l ₂ max	d ₂	a	price EUR			
inch	mm	inch	mm	mm	mm	mm	each	each	set	
N00264	No 2	2,184	64	36	9	2,8	2,1	6,204	6,824	13,028
N00356	3	2,515	56	40	9	2,8	2,1	5,424	5,966	11,390
N00448	4	2,845	48	40	11	3,5	2,7	5,232	5,755	10,987
N00544	5	3,175	44	40	11	4,0	3,0	5,040	5,544	10,584
N00640	6	3,505	40	45	12	4,5	3,4	4,920	5,412	10,332
N00836	8	4,166	36	45	13	6,0	4,9	4,764	5,240	10,004
N01032	10	4,826	32	50	16	6,0	4,9	5,040	5,544	10,584
N01228	12	5,486	28	56	17	6,0	4,9	5,424	5,966	11,390
I01620	1/4	6,350	28	56	19	6,0	4,9	5,232	5,755	10,987
I02024	5/16	7,935	24	63	22	6,0	4,9	5,820	6,402	12,222
I02424	3/8	9,525	24	63	20	7,0	5,5	6,204	6,824	13,028
I02820	7/16	11,113	20	63	20	8,0	6,2	9,044	9,948	18,992
I03220	1/2	12,700	20	70	22	9,0	7,0	9,954	10,949	20,903
I03618	9/16	14,288	18	70	22	11,0	9,0	14,014	15,415	29,429
I04018	5/8	15,875	18	70	22	12,0	9,0	14,014	15,415	29,429
I04816	3/4	19,050	16	80	22	16,0	12,0	18,536	20,390	38,926
I05614	7/8	22,225	14	80	22	18,0	14,5	26,352	28,987	55,339
I10012	1"	25,400	12	90	22	18,0	14,5	35,568	39,125	74,693
I10812	1 1/8	28,575	12	90	22	22,0	18,0	48,640	53,504	102,144
I11612	1 1/4	31,750	12	90	22	22,0	18,0	69,920	76,912	146,832
I13212	1 1/2	38,100	12	125	40	32,0	24,0	115,520	127,072	242,592

*Posebno označene stavke (**bold**) odnose se na robu koju imamo na lageru. Za ostali asortiman rabate i rokove isporuke dajemo na osnovu upita.

*Items given in **bold** figures refer to products on stock. Discount and delivery terms for other product assortment are given at request.

*Die separat gekennzeichneten artikel (**bold**) beziehen sich auf die Ware, die auf Lager liegt. Die Rabatte und Lieferzeiten für das restliche Sortiment geben wir auf Anfrage bekannt.

RUČNI UREZNICI, DVOSTEPENI, CIJEVNI NAVOJ G (BSP)

HAND TAPS, PIPE THREAD G (BSP)

HANDGEWINDEBOHRER, ROHRGEWINDE G (BSP)

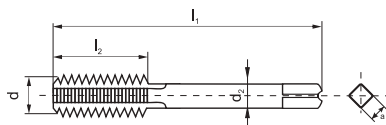

Series								NR31	NR33	NR34
	Material							HSS	HSS	HSS
Type							1st	finishing	set (2pcs)	
Finish							ground	ground	ground	
		d	P	l ₁	l ₂ max	d ₂	a	price EUR		
		inch	mm	inch	mm	mm	mm	each	each	set
G0008	G 1/8	9,728	28	63	20	7,0	5,5	7,980	8,778	16,758
G0016	1/4	13,157	19	70	22	11,0	9,0	11,856	13,042	24,898
G0024	3/8	16,662	19	70	22	12,0	9,0	14,144	15,558	29,702
G0032	1/2	20,955	14	80	22	16,0	12,0	20,528	22,581	43,109
G0040	5/8	22,911	14	80	22	18,0	14,5	30,780	33,858	64,638
G0048	3/4	26,441	14	90	22	20,0	16,0	37,620	41,382	79,002
G0056	7/8	30,201	14	90	22	22,0	18,0	49,020	53,922	102,942
G1000	1"	33,249	11	100	25	25,0	20,0	59,860	65,846	125,706
G1008	1 1/8	37,897	11	125	40	28,0	22,0	90,640	99,704	190,344
G1016	1 1/4	41,910	11	125	40	32,0	24,0	98,040	107,844	205,884
G1024	1 3/8	44,323	11	125	40	36,0	29,0	121,980	134,178	256,158
G1032	1 1/2	47,803	11	140	40	36,0	29,0	124,840	137,324	262,164
G1048	1 3/4	53,746	11	140	40	40,0	32,0	165,300	181,830	347,130
G2000	2"	59,614	11	160	40	45,0	35,0	185,260	203,786	389,046
G2016	2 1/4	65,710	11	160	40	50,0	39,0	250,800	275,880	526,680
G2032	2 1/2	75,184	11	160	40	50,0	39,0	299,260	329,186	628,446
G2048	2 3/4	81,534	11	160	40	50,0	39,0	413,260	454,586	867,846
G3000	3"	87,884	11	160	40	50,0	39,0	427,500	470,250	897,750
G3032	3 1/2	100,330	11	180	45	56,0	44,0	567,160	623,876	1191,036
G4000	4"	113,030	11	180	45	56,0	44,0	666,900	733,590	1400,490

*Posebno označene stavke (**bold**) odnose se na robu koju imamo na lageru. Za ostali asortiman rabate i rokove isporuke dajemo na osnovu upita.

*Items given in **bold** figures refer to products on stock. Discount and delivery terms for other product assortment are given at request.

*Die separat gekennzeichneten artikel (**bold**) beziehen sich auf die Ware, die auf Lager liegt. Die Rabatte und Lieferzeiten für das restliche Sortiment geben wir auf Anfrage bekannt.

RUČNI UREZNICI, DVOSTEPENI, Pg NAVOJ

HAND TAPS, Pg THREAD

HANDGEWINDEBOHRER, Pg GEWINDE

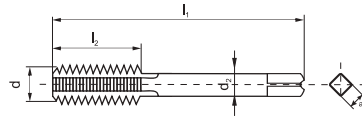

Series								NR41	NR42	NR44
	Material							HSS	HSS	HSS
	Type							1st ground	finishing ground	set (2pcs) ground
	Finish									
	d		P	l ₁	l ₂ max	d ₂	a	price EUR		
	inch	mm	inch	mm	mm	mm	mm	each	each	set
PG070	Pg 7	12,5	20	70	22	9	7	13,248	13,910	27,158
PG090	9	15,2	18	70	22	12	9	17,280	18,144	35,424
PG110	11	18,6	18	80	22	14	11	24,480	25,704	50,184
PG135	13,5	20,4	18	80	22	16	12	26,496	27,821	54,317
PG160	16	22,5	18	80	22	18	14,5	30,240	31,752	61,992
PG210	21	28,3	16	90	22	22	18	47,520	49,896	97,416
PG290	29	37,0	16	100	25	28	22	74,592	78,322	152,914
PG360	36	47,0	16	140	40	36	29	114,624	120,355	234,979
PG420	42	54,0	16	140	40	40	32	167,040	175,392	342,432
PG480	48	59,3	16	160	40	45	35	190,080	199,584	389,664

UN

RUČNI UREZNICI, DVOSTEPENI, UN NAVOJ

HAND TAPS, UN THREAD

HANDGEWINDEBOHRER, UN GEWINDE

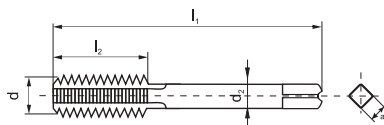

								NR45	NR46	NR48
	Material							HSS	HSS	HSS
	Type							1st ground	finishing ground	set (2pcs) ground
	Finish									
	d		P	l ₁	l ₂ max	d ₂	a	price EUR		
	inch	mm	inch	mm	mm	mm	mm	each	each	set
UN1008	1 1/8	28,575	8	138	65	22,75	17,06	48,960	51,408	100,368
UN1016	1 1/4	31,750	8	146	65	25,93	19,45	70,392	73,912	144,304
UN1024	1 3/8	34,925	8	154	76	28,14	21,10	104,040	109,242	213,282
UN1032	1 1/2	38,100	8	162	76	31,31	23,49	116,280	122,094	238,374
UN1040	1 5/8	41,275	8	170	80	33,15	24,87	134,640	141,372	276,012
UN1048	1 3/4	44,450	8	178	81	36,32	27,22	137,712	144,598	282,310
UN1056	1 7/8	47,625	8	186	90	38,55	28,93	177,840	186,732	364,572
UN2000	2"	50,800	8	194	90	41,75	31,31	183,600	192,780	376,380

*Posebno označene stavke (**bold**) odnose se na robu koju imamo na lageru. Za ostali asortiman rabate i rokove isporuke dajemo na osnovu upita.
 *Items given in **bold** figures refer to products on stock. Discount and delivery terms for other product assortment are given at request.
 *Die separat gekennzeichneten artikel (**bold**) beziehen sich auf die Ware, die auf Lager liegt. Die Rabatte und Lieferzeiten für das restliche Sortiment geben wir auf Anfrage bekannt.

**MAŠINSKI UREZNICI SA OJAČANOM DRŠKOM,
M NAVOJ**

**MACHINE TAPS WITH REINFORCED SHANK,
M COARSE THREAD**

**MASCHINENGWINDEBOHRER MIT VERSTÄRKTEM SCHAFT,
M REGELGEWINDE**

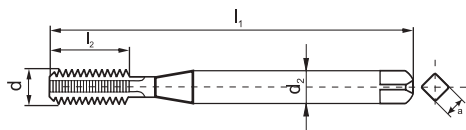

Series			NM01	NM02	NM03	NM04	NM05	NM06	NM07	NM08				
	Material		HSS	HSS	HSS	Co 5%	Co 5%	Co 5%	HSS	HSS				
	Type		A	B	C	A	B	C	interrupted	rolling				
	Finish		ground	ground	ground	ground	ground	ground	ground	ground				
	d	P	l ₁	l _{2max}	d ₂	a	price EUR							
	mm	mm	mm	mm	mm	mm	each	each	each	each	each	each		
M0160	M 1,6	0,35	40	8	2,5	2,1	8,446	9,461	8,446	10,984	12,301	10,984	14,191	
M0170	1,7	0,35	40	8	2,5	2,1	8,446	9,461	8,446	10,984	12,301	10,984	14,191	
M0180	1,8	0,35	40	8	2,5	2,1	7,344	8,230	7,344	9,547	10,692	9,547	12,334	
M0200	2	0,4	45	8	2,8	2,1	6,610	7,398	6,610	8,597	9,623	8,597	11,102	
M0220	2,2	0,45	45	9	2,8	2,1	7,344	8,230	7,344	9,547	10,692	9,547	12,334	
M0230	2,3	0,4	45	9	2,8	2,1	7,344	8,230	7,344	9,547	10,692	9,547	12,334	
M0250	2,5	0,45	50	9	2,8	2,1	6,610	7,398	6,610	8,597	9,623	8,597	11,102	
M0260	2,6	0,45	50	9	2,8	2,1	6,610	7,398	6,610	8,597	9,623	8,597	11,102	
M0300	3	0,5	56	11	3,5	2,7	5,141	5,756	5,141	6,685	7,484	6,685	8,640	7,711
M0350	3,5	0,6	56	12	4,0	3,0	5,508	6,167	5,508	7,160	8,014	7,160	9,256	
M0400	4	0,7	63	13	4,5	3,4	5,141	5,756	5,141	6,685	7,484	6,685	8,640	7,711
M0500	5	0,8	70	16	6,0	4,9	5,141	5,756	5,141	6,685	7,484	6,685	8,640	7,711
M0600	6	1	80	19	6,0	4,9	5,508	6,167	5,508	7,160	8,024	7,160	9,256	8,446
M0700	7	1	80	19	7,0	5,5	6,242	6,988	6,242	8,111	9,083	8,111	10,487	
M0800	8	1,25	90	22	8,0	6,2	6,242	6,988	6,242	8,111	9,083	8,111	10,487	9,547
M0900	9	1,25	90	22	9,0	7,0	7,344	8,230	7,344	9,547	10,692	9,547	12,334	
M1000	10	1,5	100	24	10,0	8,0	7,344	8,230	7,344	9,547	10,692	9,547	12,334	
M1200	12	1,75	110	28	12,0	9,0	10,368	11,610	10,368	13,478	15,098	13,478	17,420	

*Posebno označene stavke (**bold**) odnose se na robu koju imamo na lageru. Za ostali asortiman rabate i rokove isporuke dajemo na osnovu upita.

*Items given in **bold** figures refer to products on stock. Discount and delivery terms for other product assortment are given at request.

*Die separat gekennzeichneten artikel (**bold**) beziehen sich auf die Ware, die auf Lager liegt. Die Rabatte und Lieferzeiten für das restliche Sortiment geben wir auf Anfrage bekannt.

**MAŠINSKI UREZNICI SA OJAČANOM DRŠKOM
I SPIRALNIM ŽLIJEBOM, M NAVOJ**

**MACHINE TAPS WITH REINFORCED SHANK,
M COARSE THREAD - SPIRAL FLUTE**

**MASCHINENGEWINDEBOHRER MIT VERSTARKTEM SCHAFT,
M REGELGEWINDE - SPIRALNUTEN**

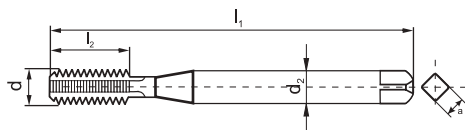

Series									NM11	NM12	NM15	NM16
	Material								HSS	HSS	Co 5%	Co 5%
Type								sp.fl. 15°	sp.fl. 35°	sp.fl. 15°	sp.fl. 35°	
Finish								ground	ground	ground	ground	
								price EUR				
	d	P	l ₁	15° l ₂ max	35° l ₂ max	d ₂	a	each	each	each	each	
	mm	mm	mm	mm	mm	mm	mm					
M0020	M 2	0,4	45	8	4	2,8	2,1	8,726	9,180	11,340	11,934	
M0022	2,2	0,45	45	9	5	2,8	2,1	9,418	9,914	12,247	12,884	
M0023	2,3	0,4	45	9	4	2,8	2,1	9,418	9,914	12,247	12,884	
M0025	2,5	0,45	50	9	5	2,8	2,1	8,726	9,180	11,340	11,934	
M0026	2,6	0,45	50	9	5	2,8	2,1	8,726	9,180	11,340	11,934	
M0030	3	0,5	56	11	5	3,5	2,7	6,977	7,344	9,072	9,547	
M0040	4	0,7	63	13	7	4,5	3,4	6,977	7,344	9,072	9,547	
M0050	5	0,8	70	16	8	6,0	4,9	6,977	7,344	9,072	9,547	
M0060	6	1	80	19	10	6,0	4,9	7,322	7,711	9,526	10,022	
M0080	8	1,25	90	22	12,5	8,0	6,2	8,024	8,446	10,433	10,984	
M0100	10	1,5	100	24	15	10,0	8,0	9,418	9,914	12,247	12,884	
M0120	12	1,75	110	28	17,5	12,0	9,0	12,744	13,414	16,567	17,442	

*Posebno označene stavke (**bold**) odnose se na robu koju imamo na lageru. Za ostali asortiman rabate i rokove isporuke dajemo na osnovu upita.

*Items given in **bold** figures refer to products on stock. Discount and delivery terms for other product assortment are given at request.

*Die separat gekennzeichneten artikel (**bold**) beziehen sich auf die Ware, die auf Lager liegt. Die Rabatte und Lieferzeiten für das restliche Sortiment geben wir auf Anfrage bekannt.

**MAŠINSKI UREZNICI SA OJAČANOM DRŠKOM,
- UNC NAVOJ**

**MACHINE TAPS WITH REINFORCED SHANK,
- UNC THREAD**

**MASCHINENGEWINDEBOHRER
MIT VERSTÄRKTEM SCHAFT, - UNC GEWINDE**

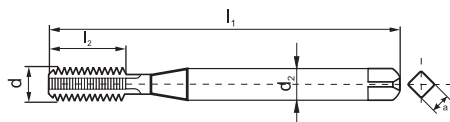

Series								NM41	NM42	NM43	NM44	NM45	NM46
	Material							HSS	HSS	HSS	Co 5%	Co 5%	Co 5%
	Type							A	B	C	A	B	C
	Finish							ground	ground	ground	ground	ground	ground
		d	P	l ₁	l _{2max}	d ₂	a	price EUR					
		inch	mm	inch	mm	mm	mm	each	each	each	each	each	each
N0001	N°1	1,854	64	45	8	2,8	2,1	8,078	9,698	8,078	11,308	13,576	11,308
N0002	2	2,184	56	45	9	2,8	2,1	7,344	8,813	7,344	10,282	12,334	10,282
N0003	3	2,515	48	50	9	2,8	2,1	6,610	7,927	6,610	9,256	11,102	9,256
N0004	4	2,845	40	56	11	3,5	2,7	5,875	7,052	5,875	8,230	9,871	8,230
N0005	5	3,175	40	56	11	3,5	2,7	5,875	7,052	5,875	8,230	9,871	8,230
N0006	6	3,505	32	56	12	4,0	3	5,508	6,610	5,508	7,711	9,256	7,711
N0008	8	4,166	32	63	13	4,5	3,4	5,508	6,610	5,508	7,711	9,256	7,711
N0010	10	4,826	24	70	16	6,0	4,9	5,875	7,052	5,875	8,230	9,871	8,230
N0012	12	5,486	24	80	17	6,0	4,9	6,610	7,927	6,610	9,256	11,102	9,256
I0016	1/4	6,350	20	80	19	6,0	4,9	6,610	7,927	6,610	9,256	11,102	9,256
I0020	5/16	7,938	18	90	22	8,0	6,2	7,344	8,813	7,344	10,282	12,334	10,282
I0024	3/8	9,525	16	100	24	10,0	8,0	8,078	9,698	8,078	11,308	13,576	11,308

**MAŠINSKI UREZNICI SA OJAČANOM DRŠKOM
- UNF NAVOJ**

**MACHINE TAPS WITH REINFORCED SHANK,
- UNF THREAD**

**MASCHINENGEWINDEBOHRER
MIT VERSTÄRKTEM SCHAFT, UNF GEWINDE**

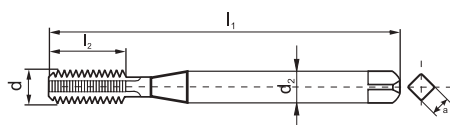

Series								NM71	NM72	NM73	NM74	NM75	NM76
	Material							HSS	HSS	HSS	Co 5%	Co 5%	Co 5%
	Type							A	B	C	A	B	C
	Finish							ground	ground	ground	ground	ground	ground
		d	P	l ₁	l _{2max}	d ₂	a	price EUR					
		inch	mm	inch	mm	mm	mm	each	each	each	each	each	each
N00264	N° 2	2,184	64	45	9	2,8	2,1	8,078	9,698	8,078	11,308	13,576	11,308
N00356	3	2,515	56	50	9	2,8	2,1	7,344	8,813	7,344	10,282	12,334	10,282
N00448	4	2,845	48	56	11	3,5	2,7	6,977	8,370	6,977	9,763	11,718	9,763
N00544	5	3,175	44	56	11	3,5	2,7	6,610	7,927	6,610	9,256	11,102	9,256
N00640	6	3,505	40	56	12	4,0	3,0	5,875	7,052	5,875	8,230	9,871	8,230
N00836	8	4,166	36	63	13	4,5	3,4	5,875	7,052	5,875	8,230	9,871	8,230
N01032	10	4,826	32	70	16	6,0	4,9	6,977	8,370	6,977	9,763	11,718	9,763
N01228	12	5,486	28	80	17	6,0	4,9	8,078	9,698	8,078	11,308	13,576	11,308
I01628	1/4	6,350	28	80	19	7,0	5,5	7,344	8,813	7,344	10,282	12,334	10,282
I02024	5/16	7,938	24	90	22	8,0	6,2	8,078	9,698	8,078	11,308	13,576	11,308
I02424	3/8	9,525	24	100	24	10,0	8,0	8,446	10,130	8,446	11,826	14,191	11,826

*Posebno označene stavke (**bold**) odnose se na robu koju imamo na lageru. Za ostali asortiman rabate i rokove isporuke dajemo na osnovu upita.

*Items given in **bold** figures refer to products on stock. Discount and delivery terms for other product assortment are given at request.

*Die separat gekennzeichneten artikel (**bold**) beziehen sich auf die Ware, die auf Lager liegt. Die Rabatte und Lieferzeiten für das restliche Sortiment geben wir auf Anfrage bekannt.

MAŠINSKI UREZNICI - M NAVOJ

**MACHINE TAPS WITH REDUCED SHANK,
M COARSE THREAD**

**MASCHINENGWINDEBOHRER
MIT ÜBERLAUFSCHAFT, M REGELGEWINDE**

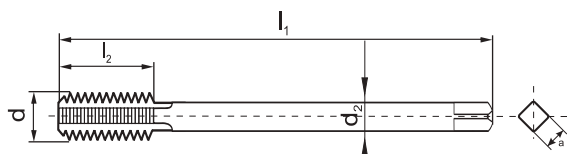

Series								NM21	NM22	NM23	NM24	NM25	NM26	NM27
	Material							HSS	HSS	HSS	Co 5%	Co 5%	Co 5%	HSS
	Type							A	B	C	A	B	C	interrupted
	Finish							ground	ground	ground	ground	ground	ground	ground
	d	P	l ₁	l _{2max}	d ₂	a	price EUR							
	mm	mm	mm	mm	mm	mm	each	each	each	each	each	each	each	
M0030	M 3	0,5	56	11	2,2		5,843	6,545	5,843	7,592	8,510	7,592	8,770	
M0040	4	0,7	63	13	2,8	2,1	5,951	6,664	5,951	7,733	8,662	7,733	8,932	
M0050	5	0,8	70	16	3,5	2,7	6,156	6,890	6,156	8,003	8,964	8,003	9,234	
M0060	6	1	80	19	4,5	3,4	6,210	6,955	6,210	8,078	9,040	8,078	9,320	
M0070	7	1	80	19	5,5	4,3	6,707	7,517	6,707	8,716	9,763	8,716	10,066	
M0080	8	1,25	90	22	6,0	4,9	6,707	7,517	6,707	8,716	9,763	8,716	10,066	
M0090	9	1,25	90	22	7,0	5,5	9,180	10,282	9,180	11,934	13,370	11,934	13,770	
M0100	10	1,5	100	24	7,0	5,5	7,819	8,759	7,819	10,163	11,383	10,163	11,729	
M0110	11	1,5	100	24	8,0	6,2	11,016	12,334	11,016	14,321	16,038	14,321	16,524	
M0120	12	1,75	110	28	9,0	7,0	9,396	10,519	9,396	12,215	13,684	12,215	14,094	
M0140	14	2	110	30	11,0	9,0	13,020	14,580	13,020	16,932	18,960	16,932	19,536	
M0160	16	2	110	32	12,0	9,0	15,300	17,136	15,300	19,896	22,272	19,896	22,956	
M0180	18	2,5	125	34	14,0	11,0	17,316	19,392	17,316	22,512	25,212	22,512	25,980	
M0200	20	2,5	140	34	16,0	12,0	21,936	24,564	21,936	28,512	31,944	28,512	32,904	
M0220	22	2,5	140	34	18,0	14,5	26,520	29,700	26,520	34,476	38,616	34,476	39,780	
M0240	24	3	160	38	18,0	14,5	29,784	33,360	29,784	38,724	43,368	38,724	44,676	
M0270	27	3	160	38	20,0	16,0	38,352	42,960	38,352	49,860	55,836	49,860	57,528	
M0300	30	3,5	180	45	22,0	18,0	46,920	52,548	46,920	60,996	68,316	60,996	70,380	
M0330	33	3,5	180	50	25,0	20,0	60,384	67,632	60,384	78,504	87,924	78,504	90,576	
M0360	36	4	200	56	28,0	22,0	67,320	75,396	67,320	87,516	98,016	87,516	100,980	
M0390	39	4	200	60	32,0	24,0	87,312	97,788	87,312	113,508	127,128	113,508	130,968	
M0420	42	4,5	200	60	32,0	24,0	97,512	109,212	97,512	126,768	141,972	126,768	146,268	
M0450	45	4,5	220	65	36,0	29,0	112,200	125,664	112,200	145,860	163,368	145,860	168,300	
M0480	48	5	250	70	36,0	29,0	134,640	150,792	134,640	175,032	196,032	175,032	201,960	
M0520	52	5	250	70	40,0	32,0	159,120	178,212	159,120	206,856	231,684	206,856	238,680	

*Posebno označene stavke (**bold**) odnose se na robu koju imamo na lageru. Za ostali asortiman rabate i rokove isporuke dajemo na osnovu upita.

*Items given in **bold** figures refer to products on stock. Discount and delivery terms for other product assortment are given at request.

*Die separat gekennzeichneten artikel (**bold**) beziehen sich auf die Ware, die auf Lager liegt. Die Rabatte und Lieferzeiten für das restliche Sortiment geben wir auf Anfrage bekannt.

MAŠINSKI UREZNICI SA SPIRALNIM ŽLIJEBOM, M NAVOJ

MACHINE TAPS WITH REDUCED SHANK,
M COARSE THREAD - SPIRAL FLUTE

MASCHINENGEWINDEBOHRER MIT ÜBERLAUFSCHAFT
M REGELGEWINDE - SPIRALNUTEN

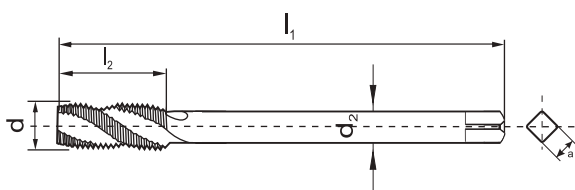

Series								NM31	NM32	NM35	NM36	
	Material							HSS	HSS	Co 5%	Co 5%	
Type							sp.fl. 15°	sp.fl. 35°	sp.fl. 15°	sp.fl. 35°		
Finish							ground	ground	ground	ground		
		d	P	l ₁	15° l ₂ max	35° l ₂ max	d ₂	a	price EUR			
		mm	mm	mm	mm	mm	mm	mm	each	each	each	each
M0030	M 3	0,5	56	11	5	2,2			7,322	7,711	9,526	10,022
M0040	4	0,7	63	13	7	2,8	2,1		7,679	8,078	9,979	10,498
M0050	5	0,8	70	16	8	3,5	2,7		7,679	8,078	9,979	10,498
M0060	6	1	80	19	10	4,5	3,4		8,024	8,446	10,433	10,984
M0080	8	1,25	90	22	13	6,0	4,9		8,370	8,813	10,886	11,459
M0100	10	1,5	100	24	15	7,0	5,5		10,465	11,016	13,608	14,321
M0120	12	1,75	110	29	17,5	9,0	7,0		12,215	12,852	15,876	16,708
M0140	14	2	110	30	20	11,0	9,0		16,284	17,136	21,168	22,272
M0160	16	2	110	32	20	12,0	9,0		18,996	19,992	24,696	25,992
M0180	18	2,5	125	34	25	14,0	11,0		25,200	26,520	32,760	34,476
M0200	20	2,5	140	34	25	16,0	12,0		26,772	28,176	34,800	36,624
M0220	22	2,5	140	34	25	18,0	14,5		32,556	34,272	42,324	44,556
M0240	24	3	160	38	30	18,0	14,5		34,884	36,720	45,348	47,736
M0270	27	3	160	38	30	20,0	16,0		46,896	49,368	60,960	64,176
M0300	30	3,5	180	45	35	22,0	18,0		57,360	60,384	74,580	78,504
M0330	33	3,5	180	50	35	25,0	20,0		69,384	73,032	90,192	94,942
M0360	36	4	200	56	40	28,0	22,0		81,784	86,088	106,320	111,912
M0390	39	4	200	60	40	32,0	24,0		106,980	112,608	139,068	146,388
M0420	42	4,5	200	60	45	32,0	24,0		121,704	128,112	158,220	166,548
M0450	45	4,5	220	65	45	36,0	29,0		136,044	143,208	176,856	186,168
M0480	48	5	250	70	50	36,0	29,0		154,260	162,384	200,544	211,104
M0520	52	5	250	70	50	40,0	32,0		182,952	192,576	237,828	250,344

*Posebno označene stavke (**bold**) odnose se na robu koju imamo na lageru. Za ostali asortiman rabate i rokove isporuke dajemo na osnovu upita.

*Items given in **bold** figures refer to products on stock. Discount and delivery terms for other product assortment are given at request.

*Die separat gekennzeichneten artikel (**bold**) beziehen sich auf die Ware, die auf Lager liegt. Die Rabatte und Lieferzeiten für das restliche Sortiment geben wir auf Anfrage bekannt.

MAŠINSKI UREZNICI, UNC NAVOJ

MACHINE TAPS WITH REDUCED SHANK, UNC THREAD

MASCHINENGWINDEBOHRER MIT ÜBERLAUFSCHAFT, UNC GEWINDE

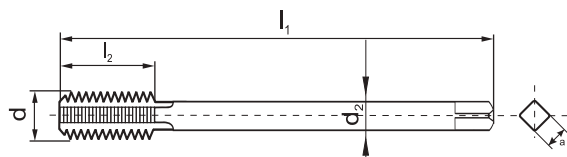

Series	Material							NM51	NM52	NM53	NM54	NM55	NM56
	Type							A	B	C	A	B	C
	Finish							ground	ground	ground	ground	ground	ground
	d		P	l ₁	l ₂ max	d ₂	a	price EUR					
	inch	mm	inch	mm	mm	mm	mm	each	each	each	each	each	each
I0016	1/4	6,350	20	80	19	4,5	3,4	6,610	7,927	6,610	9,256	11,102	9,256
I0020	5/16	7,938	18	90	22	6,0	4,9	7,344	8,813	7,344	10,282	12,334	10,282
I0024	3/8	9,525	16	100	24	7,0	5,5	8,078	9,698	8,078	11,308	13,576	11,308
I0028	7/16	11,113	14	100	24	8,0	6,2	10,282	12,334	10,282	14,396	17,269	14,396
I0032	1/2	12,700	13	110	28	9,0	7,0	11,424	13,704	11,424	15,996	19,188	15,996
I0036	9/16	14,288	12	110	30	11,0	9,0	16,728	20,076	16,728	23,424	28,104	23,424
I0040	5/8	15,875	11	110	32	12,0	9,0	15,096	18,115	15,096	21,134	25,361	21,134
I0048	3/4	19,050	10	125	34	14,0	11,0	20,400	24,480	20,400	28,560	34,272	28,560
I0056	7/8	22,225	9	140	34	18,0	14,5	25,296	30,360	25,296	35,412	42,492	35,412
I1000	1"	25,400	8	160	38	18,0	14,5	33,456	40,152	33,456	46,836	56,208	46,836
I1008	1"1/8	28,575	7	180	45	22,0	18,0	46,512	55,812	46,512	65,112	78,144	65,112
I1016	1"1/4	31,750	7	180	45	25,0	20,0	52,224	62,664	52,224	73,116	87,732	73,116
I1024	1"3/8	34,925	6	200	56	28,0	22,0	71,808	86,172	71,808	100,536	120,636	100,536
I1032	1"1/2	38,100	6	200	56	32,0	24,0	75,072	90,084	75,072	105,096	126,120	105,096
I1048	1"3/4	44,450	5	220	65	36,0	29,0	108,936	130,728	108,936	152,508	183,012	152,508
I2000	2"	50,800	4"1/2	250	70	40,0	32,0	98,328	117,996	98,328	137,664	165,192	137,664

*Posebno označene stavke (**bold**) odnose se na robu koju imamo na lageru. Za ostali asortiman rabate i rokove isporuke dajemo na osnovu upita.

*Items given in **bold** figures refer to products on stock. Discount and delivery terms for other product assortment are given at request.

*Die separat gekennzeichneten artikel (**bold**) beziehen sich auf die Ware, die auf Lager liegt. Die Rabatte und Lieferzeiten für das restliche Sortiment geben wir auf Anfrage bekannt.

**MAŠINSKI UREZNICI SA OJAČANOM DRŠKOM,
WHITWORTH NAVOJ**

**MACHINE TAPS WITH REINFORCED SHANK,
WHITWORTH THREAD**

**MASCHINENGEWINDEBOHRER MIT VERSTARKTEM SCHAFT,
WHITWORTH GEWINDE**

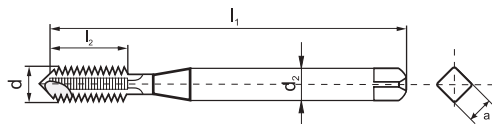

Series				NM47	NM48	NM49	NM50				
Material				HSS	HSS	HSS	HSS				
Type				B	C	sp.fl.15°	sp.fl.35°				
Finish				ground	ground	ground	ground				
		d	P	l ₁	l _{2max}	d ₂	a	price EUR			
		inch	mm	inch	mm	mm	mm	each	each	each	each
W0008	W 1/8	3,175	40	56	11	3,5	2,7	6,577	5,875	7,636	7,927
W0010	5/32	3,968	32	63	13	4,5	3,4	7,398	6,610	8,597	8,921
W0012	3/16	4,762	24	70	16	6,0	4,9	6,988	6,242	8,111	8,424
W0014	7/32	5,556	24	80	17	6,0	4,9	11,513	10,282	13,370	13,878
W0016	1/4	6,350	20	80	19	7,0	5,5	7,398	6,610	8,597	8,921
W0020	5/16	7,937	18	90	22	8,0	6,2	8,230	7,344	9,547	9,914
W0024	3/8	9,525	16	100	24	10,0	8,0	9,461	8,446	10,984	11,405

DIN 2183

MAŠINSKI UREZNICI, WHITWORTH NAVOJ

MACHINE TAPS WITH REDUCED SHANK, WHITWORTH THREAD

**MASCHINENGEWINDEBOHRER MIT UBERLAUFSCHAFT,
WHITWORTH GEWINDE**

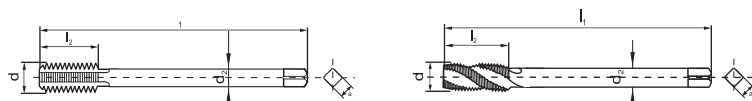

Series				NM57	NM58	NM59	NM60				
Material				HSS	HSS	HSS	HSS				
Type				B	C	sp.fl.15°	sp.fl.35°				
Finish				ground	ground	ground	ground				
		d	P	l ₁	l _{2max}	d ₂	a	price EUR			
		inch	mm	inch	mm	mm	mm	each	each	each	each
W0028	7/16	11,112	14	100	24	8,0	6,2	13,704	12,240	15,912	16,524
W0032	1/2	12,700	12	110	28	9,0	7,0	12,792	11,424	14,856	15,420
W0036	9/16	14,287	12	110	30	11,0	9,0	19,644	17,544	22,812	23,688
W0040	5/8	15,875	11	110	32	12,0	9,0	19,644	17,544	22,812	23,688
W0048	3/4	19,050	10	125	34	14,0	11,0	23,760	21,216	27,576	28,644
W0056	7/8	22,225	9	140	34	18,0	14,5	32,904	29,376	38,184	39,660
W1000	1"	25,400	8	160	38	20,0	16,0	39,300	35,088	45,612	47,364
W1008	1"1/8	28,575	7	180	45	22,0	18,0	50,724	45,288	58,872	61,140
W1016	1"1/4	31,750	7	180	45	25,0	20,0	63,972	57,120	74,256	77,112
W1024	1"3/8	34,925	6	200	56	28,0	22,0	80,880	72,216	93,876	97,488
W1032	1"1/2	38,100	6	200	56	32,0	24,0	95,508	85,272	110,856	115,116
W1040	1"5/8	41,277	5	200	60	32,0	24,0	105,096	93,840	121,992	126,684
W1048	1"3/4	44,450	5	220	65	36,0	29,0	121,092	108,120	140,556	145,968
W1056	1"7/8	47,627	4"1/2	250	70	36,0	29,0	141,660	126,480	164,424	170,748
W2000	2"	50,800	4"1/2	250	70	40,0	32,0	141,660	126,480	164,424	170,748

*Posebno označene stavke (**bold**) odnose se na robu koju imamo na lageru. Za ostali asortiman rabate i rokove isporuke dajemo na osnovu upita.

*Items given in **bold** figures refer to products on stock. Discount and delivery terms for other product assortment are given at request.

*Die separat gekennzeichneten artikel (**bold**) beziehen sich auf die Ware, die auf Lager liegt. Die Rabatte und Lieferzeiten für das restliche Sortiment geben wir auf Anfrage bekannt.

MAŠINSKI UREZNICI - Mf FINI NAVOJ

**MACHINE TAPS WITH REDUCED SHANK,
Mf FINE THREAD**

**MASCHINGEWINDEBOHRER MIT ÜBERLAUFSCHAFT,
Mf FEINGEWINDE**

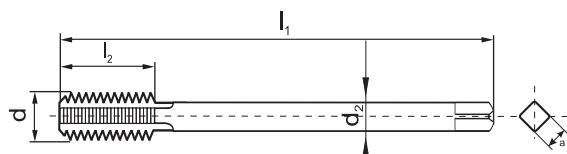

Series							NM61	NM62	NM63	NM64	NM65	NM66					
	Material						HSS	HSS	HSS	Co 5%	Co 5%	Co 5%					
	Type						A	B	C	A	B	C					
Finish						ground	ground	ground	ground	ground	ground	ground					
						d	P	l ₁	l ₂ max	d ₂	a	price EUR					
						mm	mm	mm	mm	mm	mm	each	each	each	each	each	each
030035	M	3	0,35	56	8	2,2	10,284	12,336	10,284	14,400	17,280	14,400					
040050	4	0,5	63	10	2,8	2,1	9,300	11,160	9,300	13,020	15,624	13,020					
050050	5	0,5	70	12	3,5	2,7	9,504	11,400	9,504	13,308	15,960	13,308					
060050	6	0,5	80	14	4,5	3,4	9,756	11,712	9,756	13,656	16,392	13,656					
060075	6	0,75	80	14	4,5	3,4	9,504	11,400	9,504	13,308	15,972	13,308					
070075	7	0,75	80	14	5,5	4,3	10,608	12,732	10,608	14,856	17,820	14,856					
080050	8	0,5	80	18	6,0	4,9	13,464	16,152	13,464	18,852	22,608	18,852					
080075	8	0,75	80	18	6,0	4,9	11,016	13,224	11,016	15,420	18,504	15,420					
080100	8	1	90	22	6,0	4,9	10,440	12,528	10,440	14,616	17,544	14,616					
090100	9	1	90	22	7,0	5,5	12,240	14,688	12,240	17,136	20,568	17,136					
100075	10	0,75	90	20	7,0	5,5	14,040	16,848	14,040	19,656	23,592	19,656					
100100	10	1	90	20	7,0	5,5	10,680	12,816	10,680	14,952	17,940	14,952					
100125	10	1,25	100	24	7,0	5,5	12,648	15,180	12,648	17,712	21,252	17,712					
110100	11	1	90	20	8,0	6,2	15,504	18,600	15,504	21,708	26,052	21,708					
120100	12	1	100	22	9,0	7,0	11,424	13,704	11,424	15,996	19,188	15,996					
120125	12	1,25	100	22	9,0	7,0	13,260	15,912	13,260	18,564	22,272	18,564					
120150	12	1,5	100	22	9,0	7,0	11,424	13,704	11,424	15,996	19,188	15,996					
140100	14	1	100	22	11,0	9,0	15,096	18,120	15,096	21,132	25,356	21,132					
140125	14	1,25	100	22	11,0	9,0	15,096	18,120	15,096	21,132	25,356	21,132					
140150	14	1,5	100	22	11,0	9,0	14,688	17,628	14,688	20,568	24,672	20,568					
150100	15	1	100	22	12,0	9,0	18,360	22,032	18,360	25,704	30,840	25,704					
150150	15	1,5	100	22	12,0	9,0	18,360	22,032	18,360	25,704	30,840	25,704					
160100	16	1	100	22	12,0	9,0	17,544	21,048	17,544	24,564	29,472	24,564					
160150	16	1,5	100	22	12,0	9,0	17,136	20,568	17,136	23,988	28,788	23,988					
180100	18	1	110	25	14,0	11,0	21,624	25,944	21,624	30,276	36,324	30,276					
180150	18	1,5	110	25	14,0	11,0	18,768	22,524	18,768	26,280	31,536	26,280					
180200	18	2	125	34	14,0	11,0	21,624	25,944	21,624	30,276	36,324	30,276					
200100	20	1	125	25	16,0	12,0	24,072	28,884	24,072	33,696	40,440	33,696					
200150	20	1,5	125	25	16,0	12,0	21,216	25,464	21,216	29,700	35,640	29,700					
200200	20	2	140	34	16,0	12,0	23,664	28,392	23,664	33,132	39,756	33,132					

*Posebno označene stavke (**bold**) odnose se na robu koju imamo na lageru. Za ostali asortiman rabate i rokove isporuke dajemo na osnovu upita.

*Items given in **bold** figures refer to products on stock. Discount and delivery terms for other product assortment are given at request.

*Die separat gekennzeichneten artikel (**bold**) beziehen sich auf die Ware, die auf Lager liegt. Die Rabatte und Lieferzeiten für das restliche Sortiment geben wir auf Anfrage bekannt.

Series	Material						NM61	NM62	NM63	NM64	NM65	NM66
	Type						HSS	HSS	HSS	Co 5%	Co 5%	Co 5%
	Finish						A	B	C	A	B	C
	d	P	l ₁	l ₂ max	d ₂	a	ground	ground	ground	ground	ground	ground
mm	mm	mm	mm	mm	mm	price EUR						
						each	each	each	each	each	each	
220100	22	1	125	25	18,0	14,5	32,844	39,410	32,844	45,976	55,174	45,976
220150	22	1,5	125	25	18,0	14,5	28,084	33,698	28,084	39,312	47,180	39,312
220200	22	2	140	34	18,0	14,5	31,416	37,702	31,416	43,988	52,780	43,988
240100	24	1	140	28	18,0	14,5	37,604	45,122	37,604	52,640	63,168	52,640
240150	24	1,5	140	28	18,0	14,5	31,416	37,702	31,416	43,988	52,780	43,988
240200	24	2	140	28	18,0	14,5	35,700	42,840	35,700	49,980	59,976	49,980
250150	25	1,5	140	28	18,0	14,5	49,028	58,828	49,028	68,642	82,362	68,642
260100	26	1	140	28	18,0	14,5	50,624	60,746	50,624	70,868	85,050	70,868
260150	26	1,5	140	28	18,0	14,5	41,006	49,210	41,006	57,414	68,894	57,414
270150	27	1,5	140	28	20,0	16,0	47,600	57,120	47,600	66,640	79,968	66,640
270200	27	2	140	28	20,0	16,0	50,400	60,480	50,400	70,560	84,672	70,560
280100	28	1	140	28	20,0	16,0	53,900	64,680	53,900	75,460	90,272	75,460
280150	28	1,5	140	28	20,0	16,0	49,504	59,402	49,504	69,300	83,160	69,300
280200	28	2	140	28	20,0	16,0	53,900	64,680	53,900	75,460	90,552	75,460
300100	30	1	150	28	22,0	18,0	59,500	71,400	59,500	83,300	99,960	83,300
300150	30	1,5	150	28	22,0	18,0	52,360	62,832	52,360	73,304	87,962	73,304
300200	30	2	150	28	22,0	18,0	56,168	67,396	56,168	78,638	94,360	78,638
320150	32	1,5	150	28	22,0	18,0	60,928	73,108	60,928	85,302	102,354	85,302
320200	32	2	150	28	22,0	18,0	63,728	76,468	63,728	89,222	107,058	89,222
330150	33	1,5	160	30	25,0	20,0	65,688	78,820	65,688	91,966	110,362	91,966
330200	33	2	160	30	25,0	20,0	69,020	82,824	69,020	96,628	115,948	96,628
340150	34	1,5	170	30	28,0	22,0	73,304	87,962	73,304	102,620	123,144	102,620
350150	35	1,5	170	30	28,0	22,0	75,404	90,482	75,404	105,560	126,672	105,560
360150	36	1,5	170	30	28,0	22,0	75,684	90,818	75,684	105,952	127,148	105,952
360200	36	2	170	30	28,0	22,0	78,540	94,248	78,540	109,956	131,950	109,956
360300	36	3	200	56	28,0	22,0	89,488	107,380	89,488	125,286	150,346	125,286
380150	38	1,5	170	30	28,0	22,0	81,900	98,280	81,900	114,660	137,592	114,660
390200	39	2	170	30	32,0	24,0	103,768	124,516	103,768	145,278	174,328	145,278
390300	39	3	200	56	32,0	24,0	107,072	128,492	107,072	149,898	179,886	149,898
400150	40	1,5	170	30	32,0	24,0	90,916	109,102	90,916	127,288	152,740	127,288
400200	40	2	170	30	32,0	24,0	105,672	126,812	105,672	147,938	177,534	147,938
420150	42	1,5	170	30	32,0	24,0	100,912	121,100	100,912	141,274	169,526	141,274
420200	42	2	170	30	32,0	24,0	110,460	132,552	110,460	154,644	185,570	154,644
420300	42	3	200	60	32,0	24,0	126,140	151,368	126,140	176,596	211,918	176,596
450150	45	1,5	180	32	36,0	29,0	111,860	134,232	111,860	156,604	187,922	156,604
450200	45	2	180	32	36,0	29,0	128,520	154,224	128,520	179,928	215,908	179,928
450300	45	3	200	50	36,0	29,0	146,608	175,924	146,608	205,254	246,302	205,254
480150	48	1,5	190	32	36,0	29,0	130,900	157,080	130,900	183,260	219,912	183,260
480200	48	2	190	32	36,0	29,0	168,980	202,776	168,980	236,572	283,892	236,572
480300	48	3	225	50	36,0	29,0	171,332	205,604	171,332	239,862	287,840	239,862
500150	50	1,5	190	32	36,0	29,0	164,220	197,064	164,220	229,908	275,884	229,908
500200	50	2	190	32	36,0	29,0	179,928	215,908	179,928	251,902	302,274	251,902
500300	50	3	225	50	36,0	29,0	183,260	219,912	183,260	256,564	307,874	256,564
520150	52	1,5	190	32	40,0	32,0	164,220	197,064	164,220	229,908	275,884	229,908
520200	52	2	190	32	40,0	32,0	179,928	215,908	179,928	251,902	302,274	251,902
520300	52	3	225	50	40,0	32,0	198,968	238,756	198,968	278,558	334,264	278,558

*Posebno označene stavke (**bold**) odnose se na robu koju imamo na lageru. Za ostali asortiman rabate i rokove isporuke dajemo na osnovu upita.

*Items given in **bold** figures refer to products on stock. Discount and delivery terms for other product assortment are given at request.

*Die separat gekennzeichneten artikel (**bold**) beziehen sich auf die Ware, die auf Lager liegt. Die Rabatte und Lieferzeiten für das restliche Sortiment geben wir auf Anfrage bekannt.

**MAŠINSKI UREZNICI SA SPIRALNIM ŽLIJEBOM,
Mf FINI NAVOJ**

**MACHINE TAPS WITH REDUCED SHANK,
Mf FINE THREAD - SPIRAL FLUTE**

**MASCHINENGEWINDEBOHRER MIT ÜBERLAUFSCHAFT,
Mf FEINGEWINDE - SPIRALNUTEN**

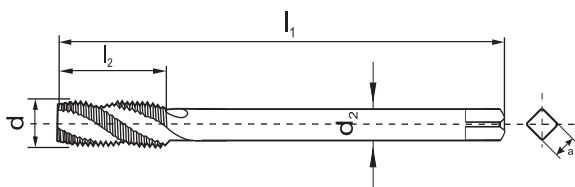

Series									NM67	NM68	NM69	NM70
	Material								HSS	HSS	Co 5%	Co 5%
Type								sp.fl. 15°	sp.fl. 35°	sp.fl. 15°	sp.fl. 35°	
Finish								ground	ground	ground	ground	
d		P	l ₁	15° l ₂ max	35° l ₂ max	d ₂	a	price EUR				
mm		mm	mm	mm	mm	mm	mm	each	each	each	each	
050050	M 5	0,5	70	12	8	3,5	2,7	11,545	12,701	16,168	17,777	
060050	6	0,5	80	14	10	4,5	3,4	11,858	13,046	16,600	18,263	
060075	6	0,75	80	14	10	4,5	3,4	11,545	12,701	16,168	17,777	
80100	8	1	90	22	12	6,0	4,9	12,690	13,964	17,766	19,548	
100075	10	0,75	90	20	12	7,0	5,5	17,064	18,770	23,890	26,276	
100100	10	1	90	20	14	7,0	5,5	12,982	14,278	18,176	19,991	
100125	10	1,25	100	24	14	7,0	5,5	15,368	16,902	21,514	23,663	
120100	12	1	100	22	16	9,0	7,0	13,878	15,271	19,429	21,373	
120125	12	1,25	100	22	16	9,0	7,0	16,114	17,723	22,561	24,818	
120150	12	1,5	100	22	16	9,0	7,0	13,878	15,271	19,429	21,373	
140100	14	1	100	22	20	11,0	9,0	18,338	20,174	25,672	28,242	
140125	14	1,25	100	22	16	11,0	9,0	18,338	20,174	25,672	28,242	
140150	14	1,5	100	22	20	11,0	9,0	17,842	19,624	24,980	27,475	
160100	16	1	100	22	20	12,0	9,0	21,319	23,447	29,851	32,832	
160150	16	1,5	100	22	20	12,0	9,0	20,822	22,907	29,149	32,065	
200100	20	1	125	25	20	16,0	12,0	29,246	32,173	40,943	45,036	
200150	20	1,5	125	25	25	16,0	12,0	25,780	28,361	36,094	39,701	
200200	20	2	140	34	32	16,0	12,0	28,750	31,622	40,252	44,269	
240100	24	1	140	28	22	18,0	14,5	50,764	55,846	71,064	78,176	
240150	24	1,5	140	28	25	18,0	14,5	42,406	46,648	59,374	65,310	
240200	24	2	140	28	32	18,0	14,5	48,202	53,018	67,480	74,228	
260100	26	1,5	140	28	25	18,0	14,5	55,356	60,886	77,504	85,246	
270150	27	1,5	140	28	28	20,0	16,0	64,260	70,686	89,964	98,966	
270200	27	2	140	28	32	20,0	16,0	68,040	74,844	95,256	104,776	
280150	28	1,5	140	28	28	20,0	16,0	66,836	73,514	93,576	102,928	
300150	30	1,5	150	28	28	22,0	18,0	70,686	77,756	98,966	108,864	
300200	30	2	150	28	32	22,0	18,0	75,824	83,412	106,148	116,774	
320150	32	1,5	150	28	28	22,0	18,0	88,676	97,538	124,152	136,556	
360150	36	1,5	170	30	30	28,0	22,0	102,172	112,392	143,038	157,346	

*Posebno označene stavke (**bold**) odnose se na robu koju imamo na lageru. Za ostali asortiman rabate i rokove isporuke dajemo na osnovu upita.

*Items given in **bold** figures refer to products on stock. Discount and delivery terms for other product assortment are given at request.

*Die separat gekennzeichneten artikel (**bold**) beziehen sich auf die Ware, die auf Lager liegt. Die Rabatte und Lieferzeiten für das restliche Sortiment geben wir auf Anfrage bekannt.

MAŠINSKI UREZNICI, UNF NAVOJ

MACHINE TAPS WITH REDUCED SHANK, UNF THREAD

MASCHINENGWINDEBOHRER MIT ÜBERLAUFSCHAFT, UNF GEWINDE

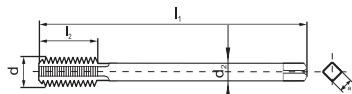

Series								NM81	NM82	NM83	NM84	NM85	NM86
	Material							HSS	HSS	HSS	Co 5%	Co 5%	Co 5%
	Type							A	B	C	A	B	C
	Finish							ground	ground	ground	ground	ground	ground
	d		P	l ₁	l _{1max}	d ₂	a	price EUR					
	inch	mm	inch	mm	mm	mm	mm	each	each	each	each	each	each
I01628	1/4	6,350	28	80	19	4,5	3,4	9,384	11,256	9,384	13,140	15,768	13,140
I02024	5/16	7,938	24	90	22	6,0	4,9	8,976	10,776	8,976	12,564	15,084	12,564
I02820	7/16	11,113	20	100	24	8,0	6,2	12,240	14,688	12,240	17,136	20,568	17,136
I03220	1/2	12,700	20	100	22	11,0	9,0	11,424	13,704	11,424	15,996	19,188	15,996
I03618	9/16	14,288	18	100	22	11,0	9,0	18,360	22,032	18,360	25,704	30,840	25,704
I04018	5/8	15,875	18	100	22	12,0	9,0	15,912	19,092	15,912	22,272	26,736	22,272
I04816	3/4	19,050	16	110	25	14,0	11,0	21,216	25,464	21,216	29,700	35,640	29,700
I05614	7/8	22,225	14	125	25	18,0	14,5	30,940	37,128	30,940	43,316	51,982	43,316
I10012	1"	25,400	12	140	28	18,0	14,5	41,412	49,700	41,412	57,974	69,566	57,974
I10812	1"1/8	28,575	12	150	28	22,0	18,0	50,456	60,550	50,456	70,644	84,770	70,644
I11612	1"1/4	31,750	12	150	28	25,0	20,0	58,072	69,692	58,072	81,298	97,566	81,298
I12412	1"3/8	34,925	12	170	30	28,0	22,0	77,588	93,100	77,588	108,626	130,354	108,626
I13212	1"1/2	38,100	12	170	30	28,0	22,0	89,964	107,954	89,964	125,944	151,144	125,944

DIN 5156 (DIN 374)

MAŠINSKI UREZNICI, CIJEVNI NAVOJ - G(BSP)

MACHINE TAPS WITH REDUCED SHANK, PIPE THREAD - G (BSP)

MASCHINENGWINDEBOHRER MIT ÜBERLAUFSCHAFT, ROHRGEWINDE - G (BSP)



Series								NM87	NM88	NM89	NM90
	Material							HSS	HSS	HSS	HSS
	Type							B	C	sp.fl. 15°	sp.fl. 35°
	Finish							ground	ground	ground	ground
	d	P	l ₁	l _{2max}	d ₂	a	price EUR				
	inch	inch	mm	mm	mm	mm	each	each	each	each	
G0008	G 1/8	28	90	20	7,0	5,5	11,856	10,776	13,476	14,004	
G0016	1/4	19	100	22	11,0	9,0	18,396	16,728	20,916	21,744	
G0024	3/8	19	100	22	12,0	9,0	19,968	18,156	22,692	23,604	
G0032	1/2	14	125	25	16,0	12,0	32,760	29,784	37,236	38,724	
G0040	5/8	14	125	25	18,0	14,5	36,804	33,456	41,820	43,488	
G0048	3/4	14	140	28	20,0	16,0	49,368	44,880	56,100	58,344	
G0056	7/8	14	150	28	22,0	18,0	58,344	53,040	66,300	68,952	
G1000	1"	11	160	30	25,0	20,0	71,808	65,280	81,600	84,864	
G1008	1"1/8	11	170	30	28,0	22,0	101,604	92,364	115,452	120,072	
G1016	1"1/4	11	170	30	32,0	24,0	123,024	111,840	139,800	145,392	
G1032	1"1/2	11	190	32	36,0	29,0	169,164	153,780	192,228	199,920	
G1048	1"3/4	11	190	32	40,0	32,0	293,088	266,448	333,060	346,380	
G2000	2"	11	220	40	45,0	35,0	321,072	291,888	364,860	379,452	

UREZNICI ZA NAVRTKU - M NAVOJ

**MACHINE NUT TAPS,
M COARSE THREAD**

**MASCHINEN MUTTER GEWINDEBOHRER,
M REGELGEWINDE**

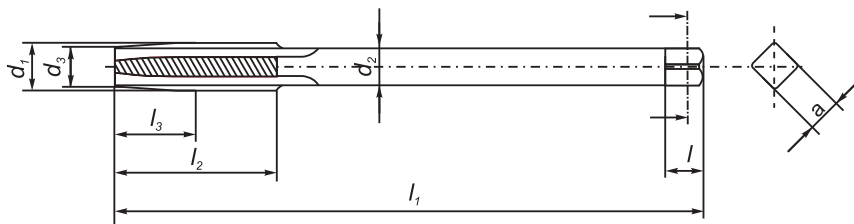

Series							NM91	NM92
Material							HSS	Co 5%
Finish							ground	ground
	d	P	l ₁	l ₂ max	d ₂	a	price EUR	
	mm	mm	mm	mm	mm	mm	each	each
M0030	M 3	0,5	70	22	2,2		8,568	11,136
M0035	3,5	0,6	80	25	2,5	2,1	10,116	13,152
M0040	4	0,7	90	25	2,8	2,1	8,568	11,136
M0045	4,5	0,75	100	28	3,5	2,7	10,560	13,728
M0050	5	0,8	100	28	3,5	2,7	9,420	12,252
M0060	6	1,0	110	32	4,5	3,4	9,876	12,840
M0070	7	1,0	110	36	5,5	4,3	13,200	17,160
M0080	8	1,25	125	40	6,0	4,9	12,240	15,912
M0090	9	1,25	140	40	7,0	5,5	15,600	20,280
M0100	10	1,5	140	45	7,0	5,5	14,280	18,564
M0110	11	1,5	160	45	8,0	6,2	20,400	26,520
M0120	12	1,75	180	50	9,0	7,0	18,360	23,868
M0140	14	2,0	200	56	11,0	9,0	23,256	30,228
M0160	16	2,0	200	63	12,0	9,0	26,928	35,004
M0180	18	2,5	220	63	14,0	11,0	41,344	53,744
M0200	20	2,5	250	70	16,0	12,0	45,152	58,704
M0220	22	2,5	280	80	18,0	14,5	55,488	72,128
M0240	24	3,0	280	80	18,0	14,5	65,280	84,864
M0270	27	3,0	315	90	20,0	16,0	89,760	116,688
M0300	30	3,5	315	100	22,0	18,0	105,536	137,200

*Posebno označene stavke (**bold**) odnose se na robu koju imamo na lageru. Za ostali asortiman rabate i rokove isporuke dajemo na osnovu upita.

*Items given in **bold** figures refer to products on stock. Discount and delivery terms for other product assortment are given at request.

*Die separat gekennzeichneten artikel (**bold**) beziehen sich auf die Ware, die auf Lager liegt. Die Rabatte und Lieferzeiten für das restliche Sortiment geben wir auf Anfrage bekannt.

MAŠINSKI UREZNICI, NPT CIJEVNI KUPASTI NAVOJ (1:16)

MACHINE TAPS, NPT TAPER THREAD (1:16)

**MASCHINENGEWINDEBOHRER
NPT KEGELIGES ROHRGEWINDE (1:16)**

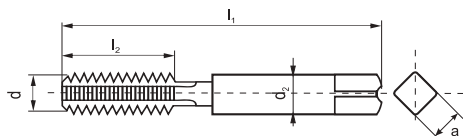

Series							NC01	NC02	NC03	NC04
	Material						HSS	Co 5%	HSS	Co 5%
Type						NPT	NPT	NPTF	NPTF	
Finish						ground	ground	ground	ground	
		d	P	l ₁	l ₂ max	d ₂	a	price EUR		
		inch	inch	mm	mm	mm	mm	each	each	each
C0004	1/16	27	54	18	8,0	6,0	13,464	17,508	14,808	19,248
C0008	1/8	27	54	19	11,0	8,3	14,688	19,092	16,152	21,000
C0016	1/4	18	62	27	14,0	10,7	17,544	22,812	19,296	25,092
C0024	3/8	18	65	27	18,0	13,5	21,216	27,576	23,340	30,336
C0032	1/2	14	80	35	17,5	13,0	38,080	49,504	41,888	54,448
C0048	3/4	14	82	35	23,0	17,2	50,592	65,776	55,648	72,352
C1000	1	11 1/2	95	45	28,5	21,4	72,352	94,064	79,584	103,456
C1016	1 1/4	11 1/2	102	45	33,0	25,0	148,920	193,600	163,820	212,960
C1032	1 1/2	11 1/2	108	45	38,0	28,5	187,000	243,100	205,700	267,420
C2000	2	11 1/2	114	45	47,5	35,5	277,440	360,680	305,180	396,740

BSPT

MAŠINSKI UREZNICI, BSPT CIJEVNI KUPASTI NAVOJ (1:16)

MACHINE TAPS, BSPT TAPER THREAD (1:16)

**MASCHINENGEWINDEBOHRER
BSPT KEGELIGES ROHRGEWINDE (1:16)**

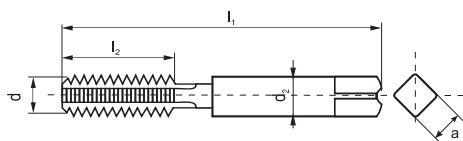

Series							NC08	NC09	
	Material						HSS	Co 5%	
Finish						ground	ground		
		d	P	l ₁	l ₂ max	d ₂	a	price EUR	
		inch	inch	mm	mm	mm	mm	each	each
C0008	1/8	28	54	19	11,0	8,3	17,952	23,340	
C0016	1/4	19	62	27	14,0	10,7	20,808	27,048	
C0024	3/8	19	65	27	18,0	13,5	25,704	33,420	
C0032	1/2	14	80	35	17,5	13,0	45,696	59,408	
C0048	3/4	14	82	35	23,0	17,2	63,104	82,032	
C1000	1	11	95	45	28,5	21,4	90,304	117,392	
C1016	1 1/4	11	102	45	33,0	25,0	186,320	242,220	
C1032	1 1/2	11	108	45	38,0	28,5	233,920	304,100	
C2000	2	11	114	45	47,5	35,5	401,200	521,560	

*Posebno označene stavke (**bold**) odnose se na robu koju imamo na lageru. Za ostali asortiman rabate i rokove isporuke dajemo na osnovu upita.

*Items given in **bold** figures refer to products on stock. Discount and delivery terms for other product assortment are given at request.

*Die separat gekennzeichneten artikel (**bold**) beziehen sich auf die Ware, die auf Lager liegt. Die Rabatte und Lieferzeiten für das restliche Sortiment geben wir auf Anfrage bekannt.

NAREZNICE OKRUGLE, M NAVOJ

ROUND DIES, M COARSE THREAD

**RUNDE SCHNEIDEISEN,
M REGELGEWINDE**

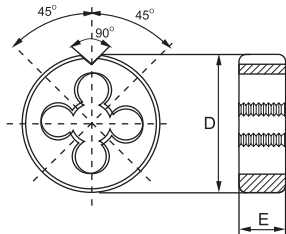

NAREZNICE OKRUGLE, UNC NAVOJ

ROUND DIES, UNC THREAD

**RUNDE SCHNEIDEISEN,
UNC REGELGEWINDEREIHE**

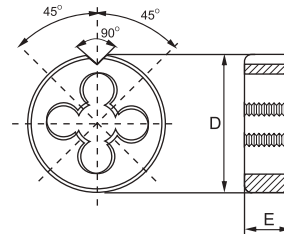

Series					NN01	NN02
	Material				HSS	HSS
	Type				B	spiral entry
	d	P	D	E	price EUR	
mm	mm	mm	mm	each	each	
M0020	M 2	0,4	16	5	8,176	9,808
M0022	2,2	0,45	16	5	8,176	9,808
M0025	2,5	0,45	16	5	7,296	8,752
M0030	3	0,5	20	5	6,720	8,064
M0035	3,5	0,6	20	5	7,200	8,640
M0040	4	0,7	20	5	6,720	8,064
M0045	4,5	0,75	20	7	7,680	9,216
M0050	5	0,8	20	7	6,912	8,288
M0060	6	1	20	7	6,912	8,288
M0070	7	1	25	9	7,840	9,408
M0080	8	1,25	25	9	7,296	8,752
M0090	9	1,25	25	9	9,216	11,056
M0100	10	1,5	30	11	8,832	10,592
M0110	11	1,5	30	11	17,280	20,736
M0120	12	1,75	38	14	16,704	20,040
M0140	14	2	38	14	20,880	25,056
M0160	16	2	45	18	28,080	33,696
M0180	18	2,5	45	18	29,520	35,424
M0200	20	2,5	45	18	29,520	35,424
M0220	22	2,5	55	22	43,200	51,840
M0240	24	3	55	22	43,200	51,840
M0270	27	3	65	25	60,480	72,576
M0300	30	3,5	65	25	60,480	72,576
M0330	33	3,5	65	25	67,680	81,216
M0360	36	4	65	25	69,840	83,808
M0390	39	4	75	30	104,400	125,280
M0420	42	4,5	75	30	108,720	130,464
M0450	45	4,5	90	36	162,720	195,264
M0480	48	5	90	36	164,160	196,992
M0520	52	5	90	36	172,800	207,360
M0560	56	5,5	105	36	225,600	270,720
M0600	60	5,5	105	36	225,600	270,720
M0640	64	6	120	36	264,000	316,800
M0680	68	6	120	36	264,000	316,800

Series					NN05	NN06
	Material				HSS	HSS
	Type				B	spiral entry
	d	P	D	E	price EUR	
mm	mm	mm	mm	each	each	
N0001	No1	64	16	5	16,800	20,160
N0002	2	56	16	5	15,360	18,432
N0003	3	48	16	5	13,920	16,704
N0004	4	40	20	5	13,440	16,128
N0005	5	40	20	5	12,480	14,976
N0006	6	32	20	7	12,480	14,976
N0008	8	32	20	7	12,480	14,976
N0010	10	24	20	7	12,480	14,976
N0012	12	24	20	7	12,480	14,976
00016	1/4	20	20	7	12,480	14,976
00020	5/16	18	25	9	13,920	16,704
00024	3/8	16	30	11	25,200	30,240
00028	7/16	14	30	11	25,200	30,240
00032	1/2	13	38	14	29,520	35,424
00036	9/16	12	38	14	32,400	38,880
00040	5/8	11	45	18	40,320	48,384
00048	3/4	10	45	18	41,760	50,112
00056	7/8	9	55	22	59,760	71,712
01000	1"	8	55	22	64,080	76,896
01008	1 1/8	7	65	25	87,120	104,544
01016	1 1/4	7	65	25	95,040	114,048
01024	1 3/8	6	65	25	95,040	114,048
01032	1 1/2	6	75	30	144,720	173,664
01048	1 3/4	5	90	36	232,560	279,072
02000	2"	4 1/2	90	36	232,560	279,072
02016	2 1/4	4 1/2	120	36	301,320	361,584
02024	2 3/8	4	120	36	351,840	421,632

*Posebno označene stavke (**bold**) odnose se na robu koju imamo na lageru. Za ostali asortiman rabate i rokove isporuke dajemo na osnovu upita.

*Items given in **bold** figures refer to products on stock. Discount and delivery terms for other product assortment are given at request.

*Die separat gekennzeichneten artikel (**bold**) beziehen sich auf die Ware, die auf Lager liegt. Die Rabatte und Lieferzeiten für das restliche Sortiment geben wir auf Anfrage bekannt.

NAREZNICE OKRUGLE, Mf FINI NAVOJ

ROUND DIES, Mf FINE THREAD

RUNDE SCHNEIDEISEN, Mf FEINGEWINDE

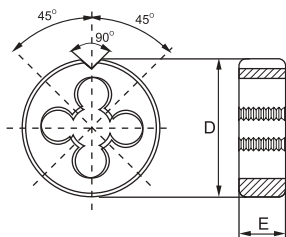

Series	Material		price EUR			
	Type		price EUR			
	d	P	D	E		
	mm	mm	mm	mm		
	M 3	0,35	20	5	11,520	13,824
035035	3,5	0,35	20	5	11,520	13,824
040050	4	0,5	20	5	10,080	12,096
045050	4,5	0,5	20	5	11,520	13,824
050050	5	0,5	20	5	10,080	12,096
055050	5,5	0,5	20	5	11,520	13,824
060075	6	0,75	20	7	10,400	12,480
070075	7	0,75	25	9	11,520	13,824
080100	8	1	25	9	11,040	13,248
090100	9	1	25	9	11,520	13,824
100100	10	1	30	11	12,960	15,552
100125	10	1,25	30	11	13,440	16,128
120125	12	1,25	38	10	24,480	29,376
120150	12	1,5	38	10	23,520	28,224
140125	14	1,25	38	10	25,920	31,104
140150	14	1,5	38	10	24,000	28,800
150150	15	1,5	38	10	33,600	40,320
160150	16	1,5	45	14	36,960	44,352
170150	17	1,5	45	14	37,440	44,928
180150	18	1,5	45	14	36,960	44,352
180200	18	2	45	14	38,400	46,080
200150	20	1,5	45	14	36,960	44,352
200200	20	2	45	14	38,400	46,080
220150	22	1,5	55	16	48,000	57,600
220200	22	2	55	16	51,600	61,920
240150	24	1,5	55	16	48,000	57,600
240200	24	2	55	16	51,600	61,920
250150	25	1,5	55	16	51,600	61,920
250200	25	2	55	16	54,000	64,800
270150	27	1,5	65	18	69,600	83,520
270200	27	2	65	18	75,120	90,144
280150	28	1,5	65	18	69,600	83,520
280200	28	2	65	18	75,120	90,144
300200	30	2	65	18	75,120	90,144

Series	Material				NN03	NN04
	Type				HSS	HSS
					B	spiral entry
	d	P	D	E	price EUR	
mm	mm	mm	mm	each	each	
300300	30	3	65	25	86,400	103,680
320150	32	1,5	65	18	75,120	90,144
320200	32	2	65	18	80,880	97,056
330150	33	1,5	65	18	75,120	90,144
320150	32	1,5	65	18	75,120	90,144
320200	32	2	65	18	80,880	97,056
330150	33	1,5	65	18	75,120	90,144
330200	33	2	65	18	80,880	97,056
330300	33	3	65	25	86,400	103,680
350150	35	1,5	65	18	75,120	90,144
360150	36	1,5	65	18	75,120	90,144
360200	36	2	65	18	84,000	100,800
360300	36	3	65	25	91,200	109,440
390150	39	1,5	75	20	120,000	144,000
390200	39	2	75	20	120,000	144,000
390300	39	3	75	30	132,000	158,400
400150	40	1,5	75	20	120,000	144,000
400200	40	2	75	20	120,000	144,000
400300	40	3	75	30	132,000	158,400
420150	42	1,5	75	20	120,000	144,000
420200	42	2	75	20	120,000	144,000
420300	42	3	75	30	132,000	158,400
420400	42	4	75	30	139,200	167,040
450150	45	1,5	90	22	153,600	184,320
450200	45	2	90	22	153,600	184,320
450300	45	3	90	36	175,200	210,240
450400	45	4	90	36	175,200	210,240
480150	48	1,5	90	22	158,400	190,080
480200	48	2	90	22	158,400	190,080
480300	48	3	90	36	180,000	216,000
480400	48	4	90	36	180,000	216,000
500150	50	1,5	90	22	158,400	190,080
500200	50	2	90	22	163,200	195,840
500300	50	3	90	36	180,000	216,000
520150	52	1,5	90	22	158,400	190,080
520200	52	2	90	22	163,200	195,840
520300	52	3	90	36	194,400	233,280
520400	52	4	90	36	194,400	233,280
550150	55	1,5	105	22	237,600	285,120
550200	55	2	105	22	237,600	285,120
550300	55	3	105	36	271,200	325,440
550400	55	4	105	36	271,200	325,440
560150	56	1,5	105	22	237,600	285,120
560200	56	2	105	22	237,600	285,120
560300	56	3	105	36	271,200	325,440
560400	56	4	105	36	271,200	325,440

*Posebno označene stavke (bold) odnose se na robu koju imamo na lageru. Za ostali asortiman rabate i rokove isporuke dajemo na osnovu upita.
 *Items given in bold figures refer to products on stock. Discount and delivery terms for other product assortment are given at request.
 *Die separat gekennzeichneten artikel (bold) beziehen sich auf die Ware, die auf Lager liegt. Die Rabatte und Lieferzeiten für das restliche Sortiment geben wir auf Anfrage bekannt.

NAREZNICE OKRUGLE, UNF FINI NAVOJ

ROUND DIES, UNF FINE THREAD

RUNDE SCHNEIDEISEN, UNF FEINGEWINDE

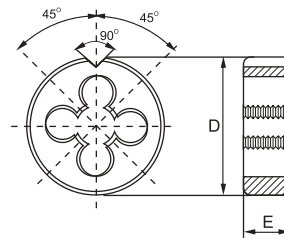
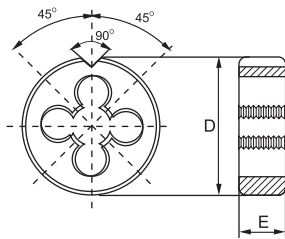

**NAREZNICE OKRUGLE,
WHITWORTH NAVOJ (BSW)**

ROUND DIES, WHITWORTH THREAD (BSW)

**RUNDE SCHNEIDEISEN,
WHITWORTH GEWINDE (BSW)**

Series	Material		HSS		HSS	
	Type		B		spiral entry	
	d	P	D	E	price EUR	
	inch	inch	mm	mm	each	each
N0264	No2	64	16	5	16,800	20,160
N0356	3	56	16	5	15,360	18,432
N0448	4	48	20	5	14,400	17,280
N0544	5	44	20	5	13,440	16,128
N0640	6	40	20	5	13,440	16,128
N0836	8	36	20	7	13,440	16,128
N1032	10	32	20	7	13,440	16,128
N1228	12	28	20	7	13,440	16,128
01628	1/4	28	20	7	13,440	16,128
02024	5/16	24	25	9	22,320	26,784
02424	3/8	24	30	11	27,360	32,832
02820	7/16	20	30	11	27,360	32,832
03220	1/2	20	38	10	31,680	38,016
03618	9/16	18	38	10	35,280	42,336
04018	5/8	18	45	14	43,920	52,704
04816	3/4	16	45	14	46,080	55,296
05614	7/8	14	55	16	61,920	74,304
10012	1	12	55	16	64,800	77,760
10812	1 1/8	12	65	18	92,160	110,592
11612	1 1/4	12	65	18	92,160	110,592
12412	1 3/8	12	65	18	94,320	113,184
13212	1 1/2	12	75	20	141,840	170,208

Series	Material		HSS		HSS	
	Type		B		spiral entry	
	d	P	D	E	price EUR	
	inch	inch	mm	mm	each	each
W00840	W1/8	40	20	5	13,600	16,320
W01224	3/16	24	20	7	13,600	16,320
W01620	1/4	20	25	9	15,200	18,240
W02018	5/16	18	25	9	15,200	18,240
W02416	3/8	16	30	11	18,400	22,080
W02814	7/16	14	30	11	18,400	22,080
W03213	1/2	12	38	14	32,400	38,880
W03612	9/16	12	38	14	35,520	42,624
W04011	5/8	11	45	18	44,400	53,280
W04411	11/16	11	45	18	47,520	57,024
W04810	3/4	10	45	18	46,080	55,296
W05609	7/8	9	55	22	65,760	78,912
W10008	1	8	55	22	65,760	78,912
W10807	1 1/8	7	65	25	95,760	114,912
W11607	1 1/4	7	65	25	95,760	114,912
W13206	1 1/2	6	75	30	159,120	190,944
W14805	1 3/4	5	90	36	256,800	308,160
W20004	2	4 1/2	90	36	256,800	308,160

*Posebno označene stavke (**bold**) odnose se na robu koju imamo na lageru. Za ostali asortiman rabate i rokove isporuke dajemo na osnovu upita.
 *Items given in **bold** figures refer to products on stock. Discount and delivery terms for other product assortment are given at request.
 *Die separat gekennzeichneten artikel (**bold**) beziehen sich auf die Ware, die auf Lager liegt. Die Rabatte und Lieferzeiten für das restliche Sortiment geben wir auf Anfrage bekannt.

NAREZNICE OKRUGLE, BSF FINI NAVOJ

ROUND DIES, BSF FINE THREAD

**RUNDE SCHNEIDEISEN,
BSF FEINGEWINDE**

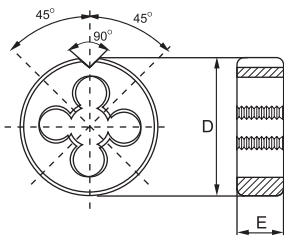

DIN 40434

NAREZNICE OKRUGLE, Pg NAVOJ

ROUND DIES, Pg THREAD

RUNDE SCHNEIDEISEN, Pg GEWINDE

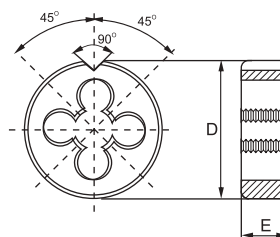

Series	Material		NN11		NN12	
	Type		HSS	HSS		
			B	spiral entry	price EUR	
	d	P	D	E	each	each
	inch	inch	mm	mm	each	each
B01232	BSF 3/16	32	20	7	17,600	21,120
B01428	7/32	28	20	7	19,200	23,040
B01626	1/4	26	25	9	19,680	23,616
B01826	9/32	26	25	9	20,800	24,960
B02022	5/16	22	25	9	19,680	23,616
B02420	3/8	20	30	11	24,000	28,800
B02818	7/16	18	30	11	24,000	28,800
B03216	1/2	16	38	10	42,000	50,400
B03616	9/16	16	38	10	45,600	54,720
B04014	5/8	14	45	14	57,600	69,120
B04414	11/16	14	45	14	62,400	74,880
B04812	3/4	12	45	14	60,000	72,000
B05611	7/8	11	55	22	85,440	102,528
B10010	1	10	55	22	85,440	102,528
B10809	1 1/8	9	65	25	124,560	149,472
B11609	1 1/4	9	65	25	124,560	149,472
B12408	1 3/8	8	65	25	132,000	158,400
B13208	1 1/2	8	75	30	206,400	247,680
B14008	1 5/8	8	75	30	237,600	285,120
B14807	1 3/4	7	90	36	312,000	374,400
B20007	2	7	90	36	312,000	374,400

Series	Material		NN15		NN16	
	Type		HSS	HSS		
			B	spiral entry	price EUR	
	d	P	D	E	each	each
	inch	inch	mm	mm	each	each
PG070	Pg 7	20	38	10	24,800	29,760
PG090	9	18	45	14	35,680	42,816
PG110	11	18	45	14	35,680	42,816
PG135	13,5	18	45	14	35,680	42,816
PG160	16	18	55	16	59,600	71,520
PG210	21	16	65	18	89,200	107,040
PG290	29	16	65	18	89,200	107,040
PG360	36	16	90	22	228,000	273,600
PG420	42	16	105	22	288,000	345,600
PG480	48	16	105	22	288,000	345,600

*Posebno označene stavke (**bold**) odnose se na robu koju imamo na lageru. Za ostali asortiman rabate i rokove isporuke dajemo na osnovu upita.

*Items given in **bold** figures refer to products on stock. Discount and delivery terms for other product assortment are given at request.

*Die separat gekennzeichneten artikel (**bold**) beziehen sich auf die Ware, die auf Lager liegt. Die Rabatte und Lieferzeiten für das restliche Sortiment geben wir auf Anfrage bekannt.

NAREZNICE OKRUGLE, CIJEVNI NAVOJ- G (BSP)

ROUND DIES, PIPE THREAD - G (BSP)

RUNDE SCHNEIDEISEN, ROHRGEWINDE - G (BSP)

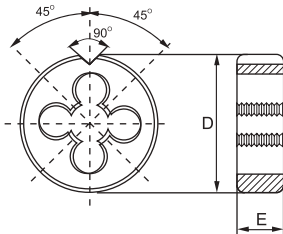

Series					NN13	NN14
	Material				HSS	HSS
	Type				B	spiral entry
	d	P	D	E	price EUR	
inch	inch	mm	mm	each	each	
G0004	G1/16	28	25	9	13,720	16,464
G0008	1/8	28	30	11	16,100	19,320
G0016	1/4	19	38	10	20,640	24,768
G0024	3/8	19	45	14	29,760	35,712
G0032	1/2	14	45	14	29,760	35,712
G0040	5/8	14	55	16	49,800	59,760
G0048	3/4	14	55	16	49,800	59,760
G0056	7/8	14	65	18	74,400	89,280
G1000	1	11	65	18	74,400	89,280
G1004	1 1/8	11	75	20	120,000	144,000
G1016	1 1/4	11	75	20	120,000	144,000
G1024	1 3/8	11	90	22	190,000	228,000
G1032	1 1/2	11	90	22	190,000	228,000
G1048	1 3/4	11	105	22	240,000	288,000
G2000	2	11	105	22	240,000	288,000
G2016	2 1/4	11	120	22	240,000	288,000

**NAREZNICE OKRUGLE,
NPT CIJEVNI KUPASTI NAVOJ (1:16)**

ROUND DIES, NPT TAPER THREAD (1:16)

**RUNDE SCHNEIDEISEN,
NPT KEGELIGES ROHRGEWINDE (1:16)**

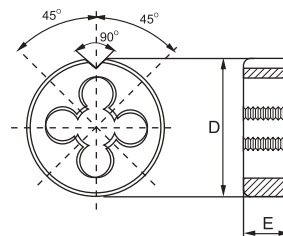

Series					NN21	NN22	NN23	NN24
	Material				HSS	HSS	HSS	HSS
	Thread				NPT	NPT	NPTF	NPTF
	Type				B	sp.entry	B	sp.entry
d	P	D	E	price EUR				
mm	mm	mm	mm	each	each	each	each	
C0004	1/16	27	25	10	23,380	28,056	26,600	31,920
C0008	1/8	27	30	11	23,380	28,056	26,600	31,920
C0016	1/4	18	38	16	29,440	35,328	33,600	40,320
C0024	3/8	18	45	18	38,080	45,696	43,520	52,224
C0032	1/2	14	45	20	58,720	70,464	67,520	81,024
C0048	3/4	14	65	21	73,400	88,080	84,400	101,280
C1000	1"	11 1/2	65	25	100,000	120,000	115,600	138,720
C1016	1 1/4	11 1/2	75	26	127,200	152,640	146,000	175,200
C1032	1 1/2	11 1/2	90	27	181,000	217,200	208,000	249,600
C2000	2"	11 1/2	105	28	240,800	288,960	278,000	333,600

*Posebno označene stavke (**bold**) odnose se na robu koju imamo na lageru. Za ostali asortiman rabate i rokove isporuke dajemo na osnovu upita.

*Items given in **bold** figures refer to products on stock. Discount and delivery terms for other product assortment are given at request.

*Die separat gekennzeichneten artikel (**bold**) beziehen sich auf die Ware, die auf Lager liegt. Die Rabatte und Lieferzeiten für das restliche Sortiment geben wir auf Anfrage bekannt.







SADRŽAJ - CONTENTS - INHALTSVERZEICHNIS

DIN	MATERIAL	SERIES		PAGE
327	HSS/HSS Co	SG01-SG09		3S
844	HSS/HSS Co	SG11-SG29		5S
845	HSS/HSS Co	SG41-SG43		7S
850	HSS/HSS Co	SG51-SG66		8S
851	HSS/HSS Co	SG71-SG79		10S
1833	HSS/HSS Co	SG81-SG88		11S
842	HSS/HSS Co	SG101-SG102		12S
847	HSS/HSS Co	SG103-SG104		13S
855	HSS/HSS Co	SG105-SG106		13S
856	HSS/HSS Co	SG107-SG108		14S
844	HSS/HSS Co	SG109-SG110		
885	HSS/HSS Co	SG111-SG114		15S

GREŠKE I PROPUSTI MOGUĆI

ERRORS AND OMISSIONS EXCEPTED

SADRŽAJ - CONTENTS - INHALTSVERZEICHNIS

DIN	MATERIAL	SERIES		PAGE
1823	HSS/HSS Co	SG115-SG118		17S
1824	HSS/HSS Co	SG119-SG122		
1880	HSS/HSS Co	SG123-SG126		18S
	HSS/HSS Co	SG127-SG130		19S
1890	HSS/HSS Co	SG131-SG132		20S
	HSS/HSS Co	SG133-SG134		22S
6513	HSS/HSS Co	SG137-SG138		24S
	HSS/HSS-Co 5%	SG181-SG182		25S

GREŠKE I PROPUSTI MOGUĆI

ERRORS AND OMISSIONS EXCEPTED

SADRŽAJ - CONTENTS - INHALTSVERZEICHNIS

DIN	MATERIAL	SERIES		PAGE
206	HSS/HSS Co	SR01-SR14		27S
208	HSS/HSS Co	SR11-SR14		29S
212	HSS/HSS Co	SR21-SR24		31S
311	HSS/HSS Co	SR37-SR38		32S
9	HSS/HSS Co	SR31-SR34		33S
219	HSS/HSS Co	SR91-SR94		34S
343	HSS/HSS Co	SU06-SU07		35S
373	HSS/HSS Co	SU01-SU04		36S
	HSS/HSS Co	SU61-SU62		38S
	HSS/HSS Co	SU35-SU42		39S
334	HSS/HSS Co	SU11-SU18		41S
335	HSS/HSS Co	SU21-SU28		43S
	HSS/HSS Co	SU51-SU52		47S
	HSS/HSS Co	SU55-SU56		
	HSS/HSS Co	SU63-SU64		
	HSS/HSS Co	SU65-SU66		48S
	HSS/HSS Co	SU67-SU68		
222	HSS/HSS Co	SU71-SU72		49S

SADRŽAJ - CONTENTS - INHALTSVERZEICHNIS

<i>DIN</i>	<i>MATERIAL</i>	<i>SERIES</i>		<i>PAGE</i>
2185		SP01		50S
2187		SP02		
238		SP05		51S
4964	HSS Co	SN21-SN26		52S
4964	HSS Co	SN31-SN36		
4964	HSS Co	SN01-SN07		53S
4964	HSS Co	SN11-SN18		

GREŠKE I PROPUSTI MOGUĆI

ERRORS AND OMISSIONS EXCEPTED

GLODALA ZA ŽLIJEB, VALJKASTA DRŠKA

SLOT CUTTERS, STRAIGHT SHANK

LONGLOCHFRÄSER, ZYLINDERSCHAFT

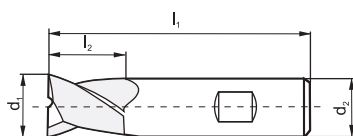

Series					SG01	SG02	SG03	SG04	SG05	SG06	SG07	SG08	SG09
	Material				HSS	HSS	HSS	Co 5%	Co 5%	Co 5%	Co 8%	Co 8%	Co 8%
	Type of shank				straight	weldon	screwed	straight	weldon	screwed	straight	weldon	screwed
	Form				B	D	H	B	D	H	B	D	H
	d ₁	l ₁	l ₂	d ₂	price EUR								
	mm	mm	mm	mm	each	each	each	each	each	each	each	each	each
00400	4	51	7	6	6,877	7,560	7,560	8,938	9,834	9,834	10,315	11,346	11,346
00450	4,5	51	7	6	8,288	9,117	9,117	10,774	11,850	11,850	12,432	13,675	13,675
00500	5	52	8	6	6,877	7,560	7,560	8,938	9,834	9,834	10,315	11,346	11,346
00550	5,5	52	8	6	8,176	8,994	8,994	10,629	11,693	11,693	12,264	13,496	13,496
00600	6	52	8	6	6,832	7,515	7,515	8,882	9,766	9,766	10,248	11,278	11,278
00650	6,5	60	10	10	10,685	11,749	11,749	13,888	15,277	15,277	16,027	17,629	17,629
00700	7	60	10	10	9,789	10,763	10,763	12,723	14,000	14,000	14,683	16,150	16,150
00750	7,5	60	10	10	10,685	11,749	11,749	13,888	15,277	15,277	16,027	17,629	17,629
00800	8	61	11	10	8,893	9,778	9,778	11,558	12,712	12,712	13,339	14,672	14,672
00850	8,5	61	11	10	10,976	12,074	12,074	14,269	15,691	15,691	16,464	18,110	18,110
00900	9	61	11	10	10,013	11,010	11,010	13,014	14,314	14,314	15,019	16,520	16,520
00950	9,5	61	11	10	10,976	12,074	12,074	14,269	15,691	15,691	16,464	18,110	18,110
01000	10	63	13	10	9,117	10,024	10,024	11,850	13,037	13,037	13,675	15,042	15,042
01050	10,5	70	13	12	18,560	20,416	20,416	24,128	26,544	26,544	27,840	30,624	30,624
01100	11	70	13	12	16,640	18,304	18,304	21,632	23,792	23,792	24,960	27,456	27,456
01200	12	73	16	12	15,360	16,896	16,896	19,968	21,968	21,968	23,040	25,344	25,344
01250	12,5	73	16	12	22,400	24,640	24,640	29,120	32,032	32,032	33,600	36,960	36,960
01300	13	73	16	12	21,120	23,232	23,232	27,456	30,208	30,208	31,680	34,848	34,848
01400	14	73	16	12	18,560	20,416	20,416	24,128	26,544	26,544	27,840	30,624	30,624
01500	15	73	16	12	21,760	23,936	23,936	28,288	31,120	31,120	32,640	35,904	35,904
01600	16	79	19	16	21,760	23,936	23,936	28,288	31,120	31,120	32,640	35,904	35,904
01700	17	79	19	16	29,440	32,384	32,384	38,272	42,096	42,096	44,160	48,576	48,576
01800	18	79	19	16	24,960	27,456	27,456	32,448	35,696	35,696	37,440	41,184	41,184
01900	19	88	22	16	34,560	38,016	38,016	44,928	49,424	49,424	51,840	57,024	57,024
02000	20	88	22	20	28,800	31,680	31,680	37,440	41,184	41,184	43,200	47,520	47,520
02100	21	88	22	20	48,800	53,680	53,680	63,440	69,780	69,780	73,200	80,520	80,520
02200	22	88	22	20	40,800	44,880	44,880	53,040	58,340	58,340	61,200	67,320	67,320
02300	23	88	22	20	59,200	65,120	65,120	76,960	84,660	84,660	88,800	97,680	97,680
02400	24	102	26	25	49,600	54,560	54,560	64,480	70,920	70,920	74,400	81,840	81,840

*Posebno označene stavke (**bold**) odnose se na robu koju imamo na lageru. Za ostali asortiman rabate i rokove isporuke dajemo na osnovu upita.

*Items given in **bold** figures refer to products on stock. Discount and delivery terms for other product assortment are given at request.

*Die separat gekennzeichneten artikel (**bold**) beziehen sich auf die Ware, die auf Lager liegt. Die Rabatte und Lieferzeiten für das restliche Sortiment geben wir auf Anfrage bekannt.

Series	SG01 SG02 SG03 SG04 SG05 SG06 SG07 SG08 SG09												
	Material	HSS	HSS	HSS	Co 5%	Co 5%	Co 5%	Co 8%	Co 8%	Co 8%			
	Type of shank	straight	weldon	screwed	straight	weldon	screwed	straight	weldon	screwed			
	Form	B	D	H	B	D	H	B	D	H			
	d ₁	l ₁	l ₂	d ₂	price EUR								
	mm	mm	mm	mm	each	each	each	each	each	each	each	each	each
02400	25	102	26	25	49,600	54,560	54,560	64,480	70,920	70,920	74,400	81,840	81,840
02600	26	102	26	25	67,200	73,920	73,920	87,360	96,100	96,100	100,800	110,880	110,880
02700	27	102	26	25	72,800	80,080	80,080	94,640	104,100	104,100	109,200	120,120	120,120
02800	28	102	26	25	60,800	66,880	66,880	79,040	86,940	86,940	91,200	100,320	100,320
02900	29	102	26	25	90,400	99,440	99,440	117,520	129,280	129,280	135,600	149,160	149,160
03000	30	102	26	25	75,200	82,720	82,720	97,760	107,540	107,540	112,800	124,080	124,080
03200	32	112	32	32	75,200	82,720	82,720	97,760	107,540	107,540	112,800	124,080	124,080
03400	34	112	32	32	115,200	126,720	126,720	149,760	164,740	164,740	172,800	190,080	190,080
03500	35	112	32	32	106,400	117,040	117,040	138,320	152,160	152,160	159,600	175,560	175,560
03600	36	112	32	32	96,000	105,600	105,600	124,800	137,280	137,280	144,000	158,400	158,400
03800	38	130	38	40	132,000	145,200	145,200	171,600	188,760	188,760	198,000	217,800	217,800
04000	40	130	38	40	120,000	132,000	132,000	156,000	171,600	171,600	180,000	198,000	198,000
04500	45	130	38	40	152,000	167,200	167,200	197,600	217,360	217,360	228,000	250,800	250,800
05000	50	147	45	50	195,200	214,720	214,720	253,760	279,140	279,140	292,800	322,080	322,080

*Posebno označene stavke (**bold**) odnose se na robu koju imamo na lageru. Za ostali asortiman rabate i rokove isporuke dajemo na osnovu upita.

*Items given in **bold** figures refer to products on stock. Discount and delivery terms for other product assortment are given at request.

*Die separat gekennzeichneten artikel (**bold**) beziehen sich auf die Ware, die auf Lager liegt. Die Rabatte und Lieferzeiten für das restliche Sortiment geben wir auf Anfrage bekannt.

GLODALA VREtenASTA, VALJKASTA DRŠKA

END MILLS, STRAIGHT SHANK

SCHAFTFRÄSER, ZYLINDERSCHAFT

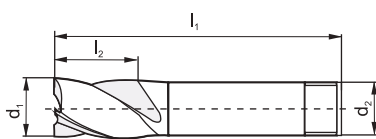

Series	SG11 SG12 SG13 SG14 SG15 SG16 SG17 SG18 SG19													
	Material					HSS	HSS	HSS	Co 5%	Co 5%	Co 5%	Co 8%	Co 8%	Co 8%
	Type of shank					straight	weldon	screwed	straight	weldon	screwed	straight	weldon	screwed
	Form					A	B	D	A	B	D	A	B	D
	d ₁	l ₁	l ₂	d ₂	Z	price EUR								
	mm	mm	mm	mm		each	each	each	each	each	each	each	each	each
00400	4	55	11	6	4	8,736	9,610	9,610	11,357	12,488	12,488	13,104	14,414	14,414
00450	4,5	55	11	6	4	10,864	11,950	11,950	14,123	15,534	15,534	16,296	17,931	17,931
00500	5	57	13	6	4	9,072	9,979	9,979	11,794	12,970	12,970	13,608	14,974	14,974
00550	5,5	57	13	6	4	11,200	12,320	12,320	14,560	16,016	16,016	16,800	18,480	18,480
00600	6	57	13	6	4	9,341	10,270	10,270	12,141	13,362	13,362	14,011	15,411	15,411
00650	6,5	66	16	10	4	12,320	13,552	13,552	16,016	17,618	17,618	18,480	20,328	20,328
00700	7	66	16	10	4	11,200	12,320	12,320	14,560	16,016	16,016	16,800	18,480	18,480
00750	7,5	66	16	10	4	12,320	13,552	13,552	16,016	17,618	17,618	18,480	20,328	20,328
00800	8	69	19	10	4	10,192	11,211	11,211	13,250	14,571	14,571	15,288	16,822	16,822
00850	8,5	69	19	10	4	13,440	14,784	14,784	17,472	19,219	19,219	20,160	22,176	22,176
00900	9	69	19	10	4	12,320	13,552	13,552	16,016	17,618	17,618	18,480	20,328	20,328
00950	9,5	69	19	10	4	13,440	14,784	14,784	17,472	19,219	19,219	20,160	22,176	22,176
01000	10	72	22	10	4	11,088	12,197	12,197	14,414	15,859	15,859	16,632	18,301	18,301
01100	11	79	22	12	4	14,000	15,400	15,400	18,200	20,026	20,026	21,000	23,106	23,106
01200	12	83	26	12	4	12,589	13,843	13,843	16,363	17,998	17,998	18,883	20,776	20,776
01300	13	83	26	12	4	22,400	24,640	24,640	29,120	32,032	32,032	33,600	36,960	36,960
01400	14	83	26	12	4	20,384	22,416	22,416	26,496	29,152	29,152	30,576	33,632	33,632
01500	15	83	26	12	4	21,184	23,296	23,296	27,536	30,288	30,288	31,776	34,960	34,960
01600	16	92	32	16	4	21,184	23,296	23,296	27,536	30,288	30,288	31,776	34,960	34,960
01700	17	92	32	16	4	33,184	36,496	36,496	43,136	47,456	47,456	49,776	54,752	54,752
01800	18	92	32	16	4	27,584	30,336	30,336	35,856	39,440	39,440	41,376	45,520	45,520
01900	19	92	32	16	4	40,800	44,880	44,880	53,040	58,352	58,352	61,200	67,328	67,328
02000	20	104	38	20	4	33,984	37,376	37,376	44,176	48,592	48,592	50,976	56,080	56,080
02200	22	104	38	20	6	43,200	47,520	47,520	56,160	61,776	61,776	64,800	71,280	71,280
02400	24	121	45	25	6	50,400	55,440	55,440	65,520	72,080	72,080	75,600	83,168	83,168
02500	25	121	45	25	6	50,400	55,440	55,440	65,520	72,080	72,080	75,600	83,168	83,168
02600	26	121	45	25	6	55,200	60,720	60,720	71,760	78,944	78,944	82,800	91,088	91,088
02800	28	121	45	25	6	56,800	62,480	62,480	73,840	81,232	81,232	85,200	93,728	93,728
03000	30	121	45	25	6	70,400	77,440	77,440	91,520	100,672	100,672	105,600	116,160	116,160
03200	32	133	53	32	6	70,400	77,440	77,440	91,520	100,672	100,672	105,600	116,160	116,160

*Posebno označene stavke (**bold**) odnose se na robu koju imamo na lageru. Za ostali asortiman rabate i rokove isporuke dajemo na osnovu upita.
 *Items given in **bold** figures refer to products on stock. Discount and delivery terms for other product assortment are given at request.
 *Die separat gekennzeichneten artikel (**bold**) beziehen sich auf die Ware, die auf Lager liegt. Die Rabatte und Liferzeiten für das restliche Sortiment geben wir auf Anfrage bekannt.

GLODALA VREtenASTA, VALJKASTA DRŠKA

END MILLS, STRAIGHT SHANK

SCHAFTFRÄSER, ZYLINDERSCHAFT

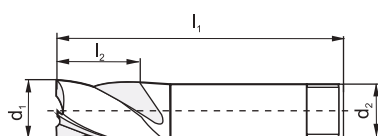

Series						SG21	SG22	SG23	SG24	SG25	SG26	SG27	SG28	SG29
	Material					HSS	HSS	HSS	Co 5%	Co 5%	Co 5%	Co 8%	Co 8%	Co 8%
	Type of shank					straight	weldon	screwed	straight	weldon	screwed	straight	weldon	screwed
	Form					A	B	D	A	B	D	A	B	D
	d ₁	l ₁	l ₂	d ₂	Z	price EUR								
	mm	mm	mm	mm		each	each	each	each	each	each	each	each	each
00400	4	55	11	6	4	9,610	10,573	10,573	12,488	13,742	13,742	14,414	15,859	15,859
00450	4,5	55	11	6	4	11,950	13,149	13,115	15,534	17,091	17,091	185,931	19,723	19,723
00500	5	57	13	6	4	9,979	10,976	10,976	12,970	14,269	14,269	14,974	16,464	16,464
00550	5,5	57	13	6	4	12,320	13,552	13,552	16,016	17,618	17,618	18,480	20,328	20,328
00600	6	57	13	6	4	10,270	11,301	11,301	13,362	14,694	14,694	15,411	16,957	16,957
00650	6,5	66	16	10	4	13,552	14,907	14,907	17,618	19,376	19,376	20,328	22,366	22,366
00700	7	66	16	10	4	12,320	13,552	13,552	16,016	17,618	17,618	18,480	20,328	20,328
00750	7,5	66	16	10	4	13,552	14,907	14,907	17,618	19,376	19,376	20,328	22,366	22,366
00800	8	69	19	10	4	11,211	12,331	12,331	14,571	16,027	16,027	16,822	18,502	18,502
00850	8,5	69	19	10	4	14,784	16,262	16,262	19,219	21,146	21,146	22,176	24,394	24,394
00900	9	69	19	10	4	13,552	14,907	14,907	17,618	19,376	19,376	20,328	22,366	22,366
00950	9,5	69	19	10	4	14,784	16,262	16,262	19,219	21,146	21,146	22,176	24,394	24,394
01000	10	72	22	10	4	12,197	13,418	13,418	15,859	17,438	17,438	18,301	20,126	20,126
01100	11	79	22	12	4	15,400	16,946	16,946	20,026	22,019	22,019	23,106	25,413	25,413
01200	12	83	26	12	4	13,843	15,232	15,232	17,998	19,802	19,802	20,776	22,848	22,848
01300	13	83	26	12	4	24,640	27,104	27,104	32,032	35,232	35,232	36,960	40,656	40,656
01400	14	83	26	12	4	22,416	24,672	24,672	29,152	32,064	32,064	33,632	36,992	36,992
01500	15	83	26	12	4	23,296	25,632	25,632	30,288	33,328	33,328	34,960	38,448	38,448
01600	16	92	32	16	4	23,296	25,632	25,632	30,288	33,328	33,328	34,960	38,448	38,448
01700	17	92	32	16	4	36,496	40,160	40,160	47,456	52,192	52,192	54,752	60,224	60,224
01800	18	92	32	16	4	30,336	33,376	33,376	39,440	43,392	43,392	45,504	50,064	50,064
01900	19	92	32	16	4	44,880	49,376	49,376	58,352	64,176	64,176	67,328	74,048	74,048
02000	20	104	38	20	4	37,376	41,120	41,120	48,592	53,456	53,456	56,080	61,680	61,680
02200	22	104	38	20	6	47,520	52,272	52,272	61,776	67,952	67,952	71,280	78,416	78,416
02400	24	121	45	25	6	55,440	60,992	60,992	72,080	79,280	79,280	83,168	91,472	91,472
02500	25	121	45	25	6	55,440	60,992	60,992	72,080	79,280	79,280	83,168	91,472	91,472
02600	26	121	45	25	6	60,720	66,800	66,800	78,944	86,832	86,832	91,088	100,192	100,192
02800	28	121	45	25	6	62,480	68,736	68,736	81,232	89,344	89,344	93,728	103,088	103,088
03000	30	121	45	25	6	77,440	85,184	85,184	100,672	110,736	110,736	116,160	127,776	127,776
03200	32	133	53	32	6	77,440	85,184	85,184	100,672	110,736	110,736	116,160	127,776	127,776

*Posebno označene stavke (**bold**) odnose se na robu koju imamo na lageru. Za ostali asortiman rabate i rokove isporuke dajemo na osnovu upita.

*Items given in **bold** figures refer to products on stock. Discount and delivery terms for other product assortment are given at request.

*Die separat gekennzeichneten artikel (**bold**) beziehen sich auf die Ware, die auf Lager liegt. Die Rabatte und Lieferzeiten für das restliche Sortiment geben wir auf Anfrage bekannt.

GLODALA VREtenASTA, KUPASTA DRŠKA

END MILLS, MORSE TAPER SHANK

SCHAFTFRÄSER, MORSEKEGEL

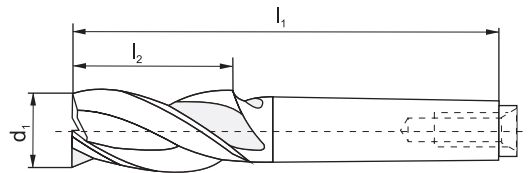

Series	Material					SG41	SG42	SG43
	Type					HSS	Co 5%	Co 8%
	d ₁	l ₁	l ₂	MT	M	N	N	N
	mm	mm	mm			price EUR		
						each	each	each
00600	6	89	22	1	M6	25,184	32,736	37,776
00700	7	89	22	1	M6	25,184	32,736	37,776
00800	8	96	25	1	M6	25,184	32,736	37,776
00900	9	96	25	1	M6	28,000	36,400	42,000
01000	10	92	22	1	M6	24,384	31,696	36,576
01100	11	92	22	1	M6	28,800	37,440	43,200
01200	12	96	26	1	M6	25,984	33,776	38,976
01300	13	96	26	1	M6	31,200	40,560	46,800
01400	14	111	26	2	M10	28,384	36,896	42,576
01500	15	111	26	2	M10	31,584	41,056	47,376
01600	16	117	32	2	M10	31,584	41,056	47,376
01700	17	117	32	2	M10	42,400	55,120	63,600
01800	18	117	32	2	M10	35,200	45,760	52,800
01900	19	117	32	2	M10	48,800	63,440	73,200
02000	20	123	38	2	M10	40,800	53,040	61,200
02100	21	123	38	2	M10	58,400	75,920	87,600
02200	22	123	38	2	M10	48,800	63,440	73,200
02300	23	123	38	2	M10	70,400	91,520	105,600
02400	24	147	45	3	M12	58,400	75,920	87,600
02500	25	147	45	3	M12	58,400	75,920	87,600
02600	26	147	45	3	M12	75,200	97,760	112,800
02700	27	147	45	3	M12	81,600	106,080	122,400
02800	28	147	45	3	M12	68,000	88,400	102,000
02900	29	147	45	3	M12	126,400	164,320	189,600
03000	30	147	45	3	M12	105,600	137,280	158,400
04000	40	188	63	4	M16	112,640	146,432	168,960
05000	50	233	75	5	M20	211,200	274,560	316,800

*Posebno označene stavke (**bold**) odnose se na robu koju imamo na lageru. Za ostali asortiman rabate i rokove isporuke dajemo na osnovu upita.

*Items given in **bold** figures refer to products on stock. Discount and delivery terms for other product assortment are given at request.

*Die separat gekennzeichneten artikel (**bold**) beziehen sich auf die Ware, die auf Lager liegt. Die Rabatte und Lieferzeiten für das restliche Sortiment geben wir auf Anfrage bekannt.

GLODALA ZA ŽLIJEB ZA SEGMENTNI KLIN, VALJKASTA DRŠKA

WOODRUFF KEYSEAT CUTTERS, STRAIGHT SHANK

SCHAFTFRÄSER, ZYLINDERSCHAFT

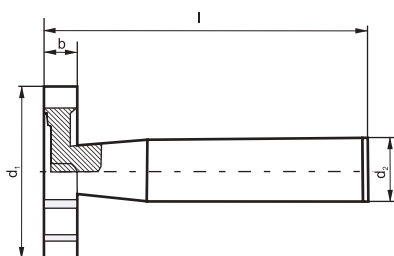

Series						SG51	SG52	SG53	SG54	SG55	SG56
	Material					HSS	Co 5%	HSS	Co 5%	HSS	Co 5%
Type of shank					straight		straight	weldon	weldon	screwed	screwed
					price EUR						
	d ₁	l	b	d ₂	Z						
	mm	mm	mm	mm	A	each	each	each	each	each	each
045010	4,5	50	1	6	10	17,760	23,088	18,648	24,240	18,648	24,240
075015	7,5	50	1,5	6	10	19,200	24,960	20,160	26,208	20,160	26,208
075020	7,5	50	2	6	10	19,200	24,960	20,160	26,208	20,160	26,208
105020	10,5	50	2	6	10	21,600	28,080	22,680	29,484	22,680	29,484
105025	10,5	50	2,5	6	10	21,600	28,080	22,680	29,484	22,680	29,484
105030	10,5	50	3	6	10	21,600	28,080	22,680	29,484	22,680	29,484
135030	13,5	56	3	10	10	24,000	31,200	25,200	32,760	25,200	32,760
135040	13,5	56	4	10	10	24,000	31,200	25,200	32,760	25,200	32,760
165030	16,5	56	3	10	10	25,920	33,696	27,216	35,376	27,216	35,376
165040	16,5	56	4	10	10	25,920	33,696	27,216	35,376	27,216	35,376
165050	16,5	56	5	10	10	25,920	33,696	27,216	35,376	27,216	35,376
195040	19,5	63	4	10	10	37,760	49,088	39,648	51,536	39,648	51,536
195050	19,5	63	5	10	12	37,760	49,088	39,648	51,536	39,648	51,536
195060	19,5	63	6	10	12	37,760	49,088	39,648	51,536	39,648	51,536
225050	22,5	63	5	10	12	44,160	57,408	46,368	60,272	46,368	60,272
225060	22,5	63	6	10	12	44,160	57,408	46,368	60,272	46,368	60,272
225080	22,5	63	8	10	12	44,160	57,408	46,368	60,272	46,368	60,272
255060	25,5	63	6	10	14	56,960	74,048	59,808	77,744	59,808	77,744
285060	28,5	63	6	10	16	64,000	83,200	67,200	87,360	67,200	87,360
285080	28,5	63	8	10	16	64,000	83,200	67,200	87,360	67,200	87,360
285100	28,5	71	10	12	16	64,000	83,200	67,200	87,360	67,200	87,360
325070	32,5	71	7	12	18	71,040	92,352	74,592	96,976	74,592	96,976
325080	32,5	71	8	12	18	71,040	92,352	74,592	96,976	74,592	96,976
325100	32,5	71	10	12	18	71,040	92,352	74,592	96,976	74,592	96,976
455100	45,5	71	10	12	22	138,240	179,712	145,152	188,704	145,152	188,704

*Posebno označene stavke (**bold**) odnose se na robu koju imamo na lageru. Za ostali asortiman rabate i rokove isporuke dajemo na osnovu upita.

*Items given in **bold** figures refer to products on stock. Discount and delivery terms for other product assortment are given at request.

*Die separat gekennzeichneten artikel (**bold**) beziehen sich auf die Ware, die auf Lager liegt. Die Rabatte und Lieferzeiten für das restliche Sortiment geben wir auf Anfrage bekannt.

GLODALA ZA ŽLIJEB ZA SEGMENTNI KLIN, VALJKASTA DRŠKA

WOODRUFF KEYSEAT CUTTERS, STRAIGHT SHANK

SCHAFTFRÄSER, ZYLINDERSCHAFT

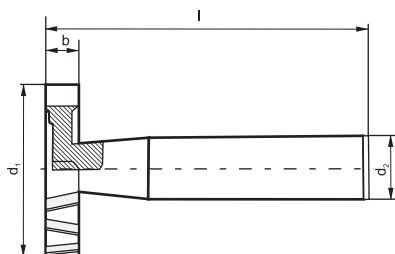

Series						SG61	SG62	SG63	SG64	SG65	SG66
	Material					HSS	Co 5%	HSS	Co 5%	HSS	Co 5%
	Type of shank					straight	straight	weldon	weldon	screwed	screwed
	d ₁	l	b	d ₂	Z	price EUR					
	mm	mm	mm	mm	A	each	each	each	each	each	each
045010	4,5	50	1	6	10	17,760	23,088	18,648	24,240	18,648	24,240
075015	7,5	50	1,5	6	10	19,200	24,960	20,160	26,208	20,160	26,208
075020	7,5	50	2	6	10	19,200	24,960	20,160	26,208	20,160	26,208
105020	10,5	50	2	6	10	21,600	28,080	22,680	29,484	22,680	29,484
105025	10,5	50	2,5	6	10	21,600	28,080	22,680	29,484	22,680	29,484
105030	10,5	50	3	6	10	21,600	28,080	22,680	29,484	22,680	29,484
135030	13,5	56	3	10	10	24,000	31,200	25,200	32,760	25,200	32,760
135040	13,5	56	4	10	10	24,000	31,200	25,200	32,760	25,200	32,760
165030	16,5	56	3	10	10	25,920	33,696	27,216	35,376	27,216	35,376
165040	16,5	56	4	10	10	25,920	33,696	27,216	35,376	27,216	35,376
165050	16,5	56	5	10	10	25,920	33,696	27,216	35,376	27,216	35,376
195040	19,5	63	4	10	10	37,760	49,088	39,648	51,536	39,648	51,536
195050	19,5	63	5	10	12	37,760	49,088	39,648	51,536	39,648	51,536
195060	19,5	63	6	10	12	37,760	49,088	39,648	51,536	39,648	51,536
225050	22,5	63	5	10	12	44,256	57,408	46,368	60,272	46,368	60,272
225060	22,5	63	6	10	12	44,256	57,408	46,368	60,272	46,368	60,272
225080	22,5	63	8	10	12	44,256	57,408	46,368	60,272	46,368	60,272
255060	25,5	63	6	10	14	56,960	74,048	59,808	77,744	59,808	77,744
285060	28,5	63	6	10	16	64,000	83,200	67,200	87,360	67,200	87,360
285080	28,5	63	8	10	16	64,000	83,200	67,200	87,360	67,200	87,360
285100	28,5	71	10	12	16	64,000	83,200	67,200	87,360	67,200	87,360
325070	32,5	71	7	12	18	71,040	92,352	74,592	96,976	74,592	96,976
325080	32,5	71	8	12	18	71,040	92,352	74,592	96,976	74,592	96,976
325100	32,5	71	10	12	18	71,040	92,352	74,592	96,976	74,592	96,976
455100	45,5	71	10	12	22	138,240	179,712	145,152	188,704	145,152	188,704

*Posebno označene stavke (**bold**) odnose se na robu koju imamo na lageru. Za ostali asortiman rabate i rokove isporuke dajemo na osnovu upita.

*Items given in **bold** figures refer to products on stock. Discount and delivery terms for other product assortment are given at request.

*Die separat gekennzeichneten artikel (**bold**) beziehen sich auf die Ware, die auf Lager liegt. Die Rabatte und Lieferzeiten für das restliche Sortiment geben wir auf Anfrage bekannt.

T - GLODALA ZA ŽLIJEB, VALJKASTA DRŠKA

T - SLOT CUTTERS, STRAIGHT SHANK

T - NUTENFRÄSER, ZYLINDERSCHAFT

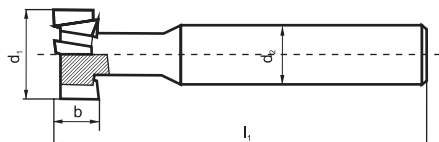

Series	Material					SG71	SG72	SG73	SG74	SG75	SG76
	Type of shank					HSS	Co 5%	HSS	Co 5%	HSS	Co 5%
						straight	straight	weldon	weldon	screwed	screwed
	d ₁	l ₁	b	d ₂	Z	price EUR					
mm	mm	mm	mm		each	each	each	each	each	each	
110040	11	53,5	4	10	6	29,088	36,360	30,540	38,184	30,540	38,184
125060	12,5	57	6	10	6	29,088	36,360	30,540	38,184	30,540	38,184
160080	16	62	8	10	6	35,520	44,400	37,296	46,620	37,296	46,620
180080	18	70	8	12	6	51,840	64,800	54,432	68,048	54,432	68,048
210090	21	74	9	12	8	58,240	72,800	61,152	76,448	61,152	76,448
250110	25	82	11	16	8	79,360	99,200	83,328	104,160	83,328	104,160
320140	32	90	14	16	8	94,720	118,400	99,456	124,320	99,456	124,320
400180	40	108	18	25	10	163,200	204,000	171,360	214,208	171,360	214,208
500220	50	124	22	32	10	254,720	318,400	267,456	334,320	267,456	334,320

DIN 851 B

T - GLODALA ZA ŽLIJEB, MK DRŠKA

T - SLOT CUTTERS, MORSE TAPER SHANK

T - NUTENFRASER, MORSEKEGELSCHAFT

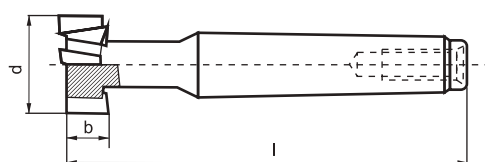

Series	Material						SG78	SG79
							HSS	Co 5%
							price EUR	
	d	l	b	MT	Z	each	each	
mm	mm	mm						
180080	18	82	8	1	6	60,160	75,200	
210090	21	102	9	2	8	69,120	86,400	
250110	25	104	11	2	8	88,960	111,200	
320140	32	111	14	2	8	102,400	128,000	
400180	40	140	18	3	10	193,920	242,400	
500220	50	187	22	4	10	268,800	336,000	
600280	60	201	28	4	12	326,400	408,000	
720350	72	248	35	5	14	464,000	580,000	
850450	85	255	40	5	14	552,320	690,400	
950440	95	264	44	5	14	640,000	800,000	

*Posebno označene stavke (bold) odnose se na robu koju imamo na lageru. Za ostali asortiman rabate i rokove isporuke dajemo na osnovu upita.

*Items given in bold figures refer to products on stock. Discount and delivery terms for other product assortment are given at request.

*Die separat gekennzeichneten artikel (bold) beziehen sich auf die Ware, die auf Lager liegt. Die Rabatte und Lieferzeiten für das restliche Sortiment geben wir auf Anfrage bekannt.

GLODALA UGAONA, VALJKASTA DRŠKA

DOVETAIL CUTTERS, STRAIGHT SHANK

WINKELFRÄSER, ZYLINDERSCHAFT

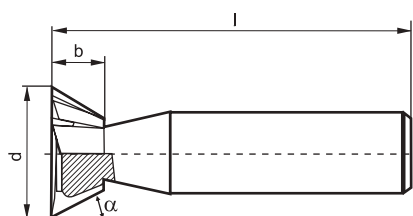

DIN 1833 - A



DIN 1833 - B



Series						SG81	SG82	SG83	SG84	SG85	SG86	SG87	SG88
	Material					HSS	Co 5%	HSS	Co 5%	HSS	Co 5%	HSS	Co 5%
	Type of shank					straight	straight	screwed	screwed	straight	straight	screwed	screwed
	d ₁	l ₁	b	α	Z	price EUR							
	mm	mm	mm			each	each	each	each	each	each	each	each
16045	16	60	4	45°	10	39,040	46,848	42,944	51,536	39,040	46,848	42,944	51,536
20045	20	63	5	45°	10	45,440	54,528	49,984	59,984	45,440	54,528	49,984	59,984
25045	25	67	6,3	45°	10	64,640	77,568	71,104	85,328	64,640	77,568	71,104	85,328
16060	16	60	6,3	60°	10	39,040	46,848	42,944	51,536	39,040	46,848	42,944	51,536
20060	20	63	8	60°	10	45,440	54,528	49,984	59,984	45,440	54,528	49,984	59,984
25060	25	67	10	60°	10	64,640	77,568	71,104	85,328	64,640	77,568	71,104	85,328
16070	16	60	7	70°	10	39,040	46,848	42,944	51,536	39,040	46,848	42,944	51,536
20070	20	63	9	70°	10	45,440	54,528	49,984	59,984	45,440	54,528	49,984	59,984
25070	25	67	11	70°	10	64,640	77,568	71,104	85,328	64,640	77,568	71,104	85,328

*Posebno označene stavke (**bold**) odnose se na robu koju imamo na lageru. Za ostali asortiman rabate i rokove isporuke dajemo na osnovu upita.

*Items given in **bold** figures refer to products on stock. Discount and delivery terms for other product assortment are given at request.

*Die separat gekennzeichneten artikel (**bold**) beziehen sich auf die Ware, die auf Lager liegt. Die Rabatte und Lieferzeiten für das restliche Sortiment geben wir auf Anfrage bekannt.

UGAONA GLODALA, JEDNOSTRANA

ANGULAR CUTTERS WITH PLAIN BORE

AUFSTECK - WINKELNSTIRNFRÄSER



Series							SG101	SG102
	Material						HSS	Co 5%
	Type						A	A
	β	d_1	b	d_2	d_3	l	price EUR	
	js16	js14	H7	js15	js14	each	each	
045040	45°	40	10	10	15	5,5	46,800	58,500
045050	45°	50	13	13	19	7,5	49,200	61,500
045063	45°	63	18	16	23	12	75,400	94,250
045080	45°	80	22	22	30	14	111,600	139,500
045100	45°	100	28	27	39	17	165,600	207,000
045125	45°	125	36	32	46	24	253,200	316,500
045160	45°	160	45	40	56	31	450,000	562,500
050040	50°	40	13	10	15	8	50,000	62,500
050050	50°	50	16	13	19	10	53,400	66,750
050063	50°	63	20	16	23	12	82,000	102,500
050080	50°	80	25	22	30	14	119,200	149,000
050100	50°	100	32	27	39	17	176,800	221,000
050125	50°	125	40	32	46	24	270,000	337,500
050160	50°	160	50	40	56	31	480,000	600,000
055040	55°	40	13	10	15	8	50,000	62,500
055050	55°	50	16	13	19	10	53,400	66,750
055063	55°	63	20	16	23	12	82,000	102,500
055080	55°	80	25	22	30	14	119,200	149,000
055100	55°	100	32	27	39	17	176,800	221,000
055125	55°	125	40	32	46	24	270,000	337,500
055160	55°	160	50	40	56	31	480,000	600,000
060040	60°	40	13	10	15	8	50,000	62,500
060050	60°	50	16	13	19	10	53,400	66,750
060063	60°	63	20	16	23	12	82,000	102,500
060080	60°	80	25	22	30	14	119,200	149,000
060100	60°	100	32	27	39	17	176,800	221,000
060125	60°	125	40	32	46	24	270,000	337,500
060160	60°	160	50	40	56	31	480,000	600,000

*Posebno označene stavke (**bold**) odnose se na robu koju imamo na lageru. Za ostali asortiman rabate i rokove isporuke dajemo na osnovu upita.

*Items given in **bold** figures refer to products on stock. Discount and delivery terms for other product assortment are given at request.

*Die separat gekennzeichneten artikel (**bold**) beziehen sich auf die Ware, die auf Lager liegt. Die Rabatte und Lieferzeiten für das restliche Sortiment geben wir auf Anfrage bekannt.

UGAONA GLODALA, SIMETRIČNA

DOUBLE EQUAL - ANGULAR CUTTERS

PRISMENFRÄSER

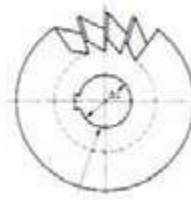

Series					SG103	SG104
	Material				HSS	Co 5%
	Type				A	A
	δ	d_1	b	d_2	price EUR	
	$\pm 30'$	js16	js16	H7	each	each
045050	45°	50	8	16	54,400	68,000
045063	45°	63	10	22	58,320	72,900
045080	45°	80	12	27	86,000	107,500
045100	45°	100	18	32	128,640	160,800
060050	60°	50	10	16	59,600	74,500
060063	60°	63	14	22	67,600	84,500
060080	60°	80	18	27	106,960	133,700
060100	60°	100	25	32	186,920	233,650
090050	90°	50	14	16	72,800	91,000
090063	90°	63	20	22	80,640	100,800
090080	90°	80	22	27	119,640	149,550
090100	90°	100	32	32	224,160	280,200

DIN 855

POLUKRUŽNA UDUBLJENA GLODALA

CONCAVE MILLING CUTTERS

HALBROUND - PROFILFRÄSER (KONKAV)

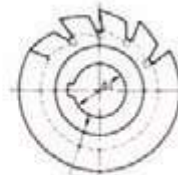
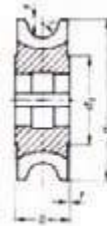

Series								SG105	SG106
	Material							HSS	Co 5%
	Form							A	A
	r	d_1	d_2	d_3	b	f	t	price EUR	
	H11	js16	H7		mm			each	each
100059	1	50	16		6	0,2		35,200	44,000
125050	1,25	50	16		6	0,2		35,600	44,500
160050	1,6	50	16		8	0,25		39,600	49,500
200050	2	50	16		9	0,25		42,000	52,500
250063	2,5	63	22		10	0,3		52,800	66,000
300063	3	63	22		12	0,3		59,600	74,500
315063	3,15	63	22		12	0,3		60,800	76,000
400063	4	63	22		16	0,4		72,800	91,000
500063	5	63	22		20	0,5		82,800	103,500
600080	6	80	27	41	24	0,6	0,5	126,800	158,500
630080	6,3	80	27	41	24	0,6	0,5	131,200	164,000
800080	8	80	27	41	32	0,8	0,5	163,600	204,500
100100	10	100	32	47	36	1	0,5	258,400	323,000
120100	12	100	32	47	40	1,2	0,5	290,800	363,500
125100	12,5	100	32	47	40	1,2	0,5	294,000	367,500
160125	16	125	32	47	50	1,6	0,5	504,000	630,000
200125	20	125	32	47	60	2	0,5	596,000	745,000

POLUKRUŽNA ISPUPČENA GLODALA

CONVEX MILLING CUTTERS

HALBROUND - PROFILFRÄSER, KONVEX

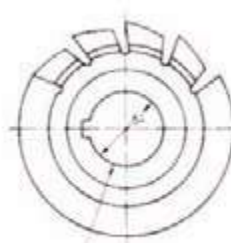
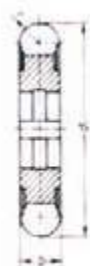

Series	Material				SG107	SG108
	r	d ₁	d ₂	b	HSS	Co 5%
	h11	js16	H7		price EUR	
					each	each
100050	1	50	16	2	23,000	28,750
125050	1,25	50	16	2,5	24,880	31,100
160050	1,6	50	16	3,2	26,000	32,500
200050	2	50	16	4	26,400	33,000
250050	2,5	63	22	5	31,400	39,250
300063	3	63	22	6	33,760	42,200
315063	3,15	63	22	6,3	40,640	50,800
400063	4	63	22	8	44,200	55,250
500063	5	63	22	10	51,480	64,350
600080	6	80	27	12	67,640	84,550
630080	6,3	80	27	12,6	69,840	87,300
800080	8	80	27	16	82,000	102,500
100100	10	100	32	20	134,320	167,900
120100	12	100	32	24	156,200	195,250
125100	12,5	100	32	25	176,000	220,000
160125	16	125	32	32	270,400	338,000
200125	20	125	32	40	402,000	502,500

DIN 884

VALJKASTA GLODALA

SOLID CYLINDRICAL CUTTERS

WÄLZENFRASER

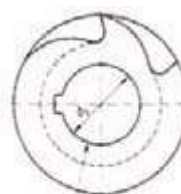
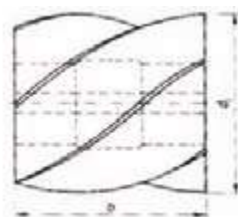

Series	Material			SG109	SG110
	d ₁	b	d ₂	HSS	Co 5%
	js16	js16	H7	price EUR	
				each	each
050040	50	40	22	85,400	106,750
050063	50	63	22	126,720	158,400
050080	50	80	22	156,520	195,650
063050	63	50	27	145,200	181,500
063070	63	70	27	193,840	242,300
080063	80	63	32	273,080	341,350
080100	80	100	32	394,000	492,500
100070	100	70	40	407,200	509,000

*Posebno označene stavke (**bold**) odnose se na robu koju imamo na lageru. Za ostali asortiman rabate i rokove isporuke dajemo na osnovu upita.

*Items given in **bold** figures refer to products on stock. Discount and delivery terms for other product assortment are given at request.

*Die separat gekennzeichneten artikel (**bold**) beziehen sich auf die Ware, die auf Lager liegt. Die Rabatte und Lieferzeiten für das restliche Sortiment geben wir auf Anfrage bekannt.

KOTURASTA GLODALA

SIDE AND FACE MILLING CUTTERS

SCHEIBENFRÄSER

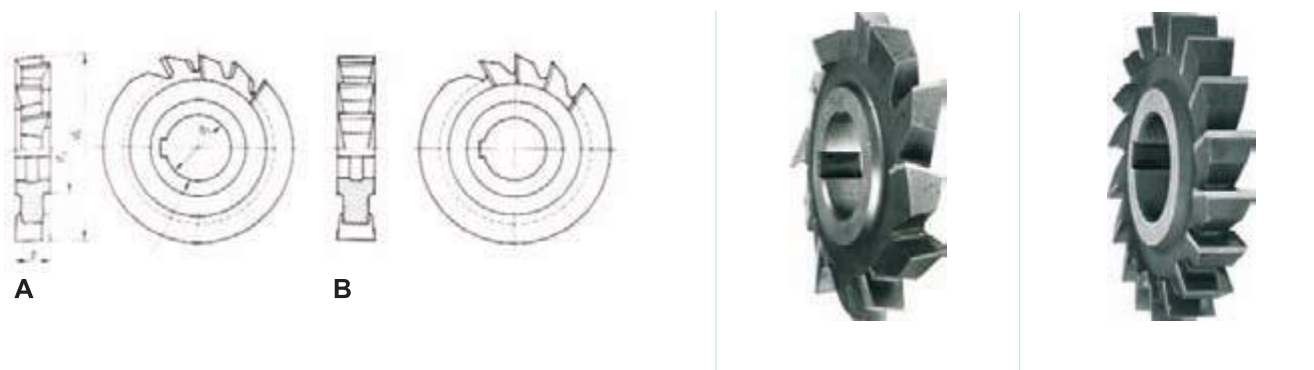

Series						SG111	SG112	SG113	SG114
	Material					HSS	Co 5%	HSS	Co 5%
	Type					A	A	B	B
	d ₁	b	d ₂	d ₃		price EUR			
js16	k11	H7	mm	z	each	each	each	each	
050004	50	4	16	27	12	42,800	53,500	42,800	53,500
050005	50	5	16	27	12	43,600	54,500	43,600	54,500
050006	50	6	16	27	12	45,600	57,000	45,600	57,000
050008	50	8	16	27	12	49,200	61,500	49,200	61,500
050010	50	10	16	27	12	52,800	66,000	52,800	66,000
063004	63	4	22	34	12	47,600	59,500	47,600	59,500
063005	63	5	22	34	12	47,600	59,500	47,600	59,500
063006	63	6	22	34	12	48,800	61,000	48,800	61,000
063008	63	8	22	34	12	56,800	71,000	56,800	71,000
063010	63	10	22	34	12	60,800	76,000	60,800	76,000
063012	63	12	22	34	12	66,800	83,500	66,800	83,500
063014	63	14	22	34	12	72,000	90,000	72,000	90,000
063016	63	16	22	34	12	78,400	98,000	78,400	98,000
080005	80	5	27	41	14	62,800	78,500	62,800	78,500
080006	80	6	27	41	14	66,400	83,000	66,400	83,000
080008	80	8	27	41	14	72,800	91,000	72,800	91,000
080010	80	10	27	41	14	79,600	99,500	79,600	99,500
080012	80	12	27	41	14	91,200	114,000	91,200	114,000
080014	80	14	27	41	14	96,800	121,000	96,800	121,000
080016	80	16	27	41	14	106,000	132,500	106,000	132,500
080018	80	18	27	41	14	114,000	142,500	114,000	142,500
080020	80	20	27	41	14	121,600	152,000	121,600	152,000
100006	100	6	32	47	16	88,000	110,000	88,000	110,000
100008	100	8	32	47	16	100,000	125,000	100,000	125,000
100010	100	10	32	47	16	116,000	145,000	116,000	145,000
100012	100	12	32	47	16	129,600	162,000	129,600	162,000
100014	100	14	32	47	16	143,200	179,000	143,200	179,000
100016	100	16	32	47	16	149,200	186,500	149,200	186,500
100018	100	18	32	47	16	160,800	201,000	160,800	201,000
100020	100	20	32	47	16	167,600	209,500	167,600	209,500
100022	100	22	32	47	16	182,800	228,500	182,800	228,500
100025	100	25	32	47	16	197,200	246,500	197,200	246,500

*Posebno označene stavke (**bold**) odnose se na robu koju imamo na lageru. Za ostali asortiman rabate i rokove isporuke dajemo na osnovu upita.

*Items given in **bold** figures refer to products on stock. Discount and delivery terms for other product assortment are given at request.

*Die separat gekennzeichneten artikel (**bold**) beziehen sich auf die Ware, die auf Lager liegt. Die Rabatte und Lieferzeiten für das restliche Sortiment geben wir auf Anfrage bekannt.

Series						SG111	SG112	SG113	SG114
	Material					HSS	Co 5%	HSS	Co 5%
	Type					A	A	B	B
	d ₁	b	d ₂	d ₃	z	price EUR			
js16	k11	H7	mm	z	each	each	each	each	
125008	125	8	32	47	18	134,400	168,000	134,400	168,000
125010	125	10	32	47	18	151,600	189,500	151,600	189,500
125012	125	12	32	47	18	169,600	212,000	169,600	212,000
125014	125	14	32	47	18	194,800	243,500	194,800	243,500
125016	125	16	32	47	18	210,400	263,000	210,400	263,000
125018	125	18	32	47	18	229,200	286,500	229,200	286,500
125020	125	20	32	47	18	246,400	308,000	246,400	308,000
125022	125	22	32	47	18	294,800	368,500	294,800	368,500
125025	125	25	32	47	18	299,600	374,500	299,600	374,500
125028	125	28	32	47	18	325,200	406,500	325,200	406,500
160010	160	10	40	55	22	307,200	384,000	307,200	384,000
160012	160	12	40	55	22	312,800	391,000	312,800	391,000
160014	160	14	40	55	22	319,600	399,500	319,600	399,500
160016	160	16	40	55	22	343,200	429,000	343,200	429,000
160018	160	18	40	55	22	366,000	457,500	366,000	457,500
160020	160	20	40	55	22	391,200	489,000	391,200	489,000
160022	160	22	40	55	22	428,800	536,000	428,800	536,000
160025	160	25	40	55	22	474,400	593,000	474,400	593,000
160028	160	28	40	55	22	519,600	649,500	519,600	649,500
160032	160	32	40	55	22	544,000	680,000	544,000	680,000
200012	200	12	40	55	24	509,200	636,500	509,200	636,500
200014	200	14	40	55	24	518,800	648,500	518,800	648,500
200016	200	16	40	55	24	530,000	662,500	530,000	662,500
200018	200	18	40	55	24	552,000	690,000	552,000	690,000
200020	200	20	40	55	24	580,000	725,000	580,000	725,000
200022	200	22	40	55	24	596,000	745,000	596,000	745,000
200025	200	25	40	55	24	698,000	872,500	698,000	872,500
200028	200	28	40	55	24	720,000	900,000	720,000	900,000
200032	200	32	40	55	24	896,000	1120,000	896,000	1120,000
200036	200	36	40	55	24	1260,000	1575,000	1260,000	1575,000
200040	200	40	40	55	24	1760,000	2200,000	1760,000	2200,000

*Posebno označene stavke (**bold**) odnose se na robu koju imamo na lageru. Za ostali asortiman rabate i rokove isporuke dajemo na osnovu upita.

*Items given in **bold** figures refer to products on stock. Discount and delivery terms for other product assortment are given at request.

*Die separat gekennzeichneten artikel (**bold**) beziehen sich auf die Ware, die auf Lager liegt. Die Rabatte und Lieferzeiten für das restliche Sortiment geben wir auf Anfrage bekannt.

UGAONA GLODALA

ANGULAR CUTTERS FOR TOOL-MAKING

WINKELFRÄSER FÜR WERKZEUGE

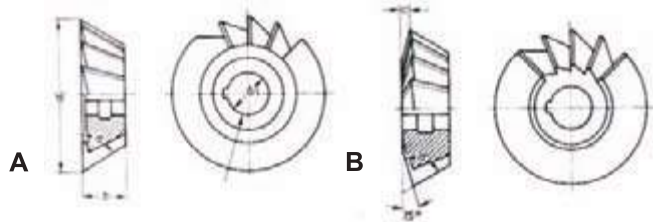

Series							SG115	SG116	SG117	SG118
	Material						HSS	Co 5%	HSS	Co 5%
	Type						A	A	B	B
	\bar{b}	d_1	b	c	d_2	price EUR				
$+1^\circ$	js16			H7	each	each	each	each		
060050	60°	50	12		16	50,400	63,000			
065050	65°	50	12		16	50,400	63,000			
075050	75°	50	12		16	50,400	63,000			
060063	60°	63	18		22	76,000	95,000			
070063	70°	63	18		22	76,000	95,000			
075063	75°	63	18		22	76,000	95,000			
080063	80°	63	18		22	76,000	95,000			
070050	70°	50	14	2	16			55,200	69,000	
075050	75°	50	16	2	16			55,200	69,000	
080050	80°	50	16	2	16			55,200	69,000	
060063	60°	63	14	3	22			79,200	99,000	
070063	70°	63	18	3	22			79,200	99,000	
075063	75°	63	18	3	22			79,200	99,000	
080063	80°	63	20	3	22			79,200	99,000	

DIN 1824

UGAONA GLODALA ZA ŽLJEBOVE, SA PODSTRUGANIM ZUBIMA

TOOL-MAKING ANGULAR CUTTERS, FOR TOOLS WITH RELIEVED TEETH

LÜCKENFRÄSER FÜR WERKZEUGE

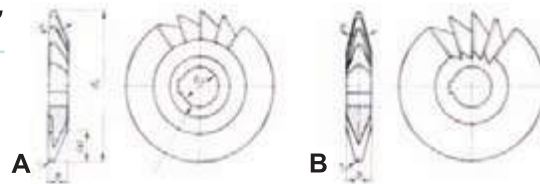

Series							SG119	SG120	SG121	SG122	
	Material						HSS	Co 5%	HSS	Co 5%	
	Type						A	A	B	B	
	\bar{b}	d_1	b	d_2	r	X \approx	price EUR				
$+1^\circ$	js16	h12	H7	$\pm 0,1$	Form A	Form B	each	each	each	each	
018063	18°	63	5,6	16	1	11,9	11,9	47,600	59,500	44,800	56,000
018080	18°	80	9	22	1,25	21	21,1	75,200	94,000	71,600	89,500
018100	18°	100	11,2	22	1,6	25,9	26	113,600	142,000	108,000	135,000
024063	24°	63	7,1	16	1	12,2	12,3	51,600	64,500	49,200	61,500
024080	24°	80	11,2	22	1,25	20,5	20,6	80,800	101,000	76,800	96,000
024100	24°	100	14	22	1,6	25,5	25,6	123,200	154,000	117,200	146,500
030063	30°	63	8	16	1	11,1	11,1	53,600	67,000	51,600	64,500
030080	30°	80	12,5	22	1,25	18,2	18,3	85,600	107,000	81,200	101,500
030100	30°	100	18	22	1,6	26,8	26,9	144,000	180,000	137,600	172,000

**ČEONA NASADNA GLODALA
SA POPREČNIM ŽLJEBOVIMA**

**SHELL END MILLS
WITH TENON DRIVE**

**WALTZENSTIRNFRÄSER
MIT QURENUT**

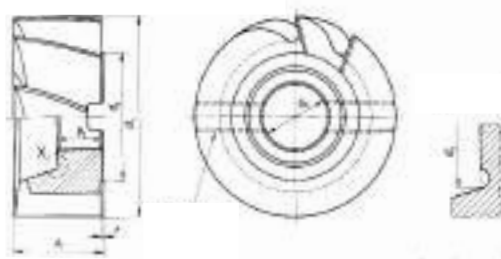

Series								SG123	SG124
Material								HSS	Co 5%
Form								N	N
								price EUR	
	d ₁	b ₁	b ₂	d ₂	d ₃	d ₄	t	each	each
	js16	k16	-1	H7	min.	min.	max.		
040032	40	32	19	16	23			58,800	73,500
050036	50	36	21	22	30			83,600	104,500
063040	63	40	23	27	38			124,000	155,000
080045	80	45	23	27	38	49	0,5	202,000	252,500
100050	100	50	26	32	45	59	0,5	322,000	402,500
125056	125	56	29	40	56	71	0,5	573,600	717,000
160063	160	63	32	50	67	91	0,5	990,000	1237,500

**ČEONA NASADNA GLODALA
SA POPREČNIM ŽLJEBOVIMA, ZA TEŠKU OBRADU**

**SHELL END MILLS
WITH TENON DRIVE, HEAVY-DUTY**

**WALTZENSTIRNFRÄSER
MIT QURENUT FÜR SCHWERE BEARBEITUNG**

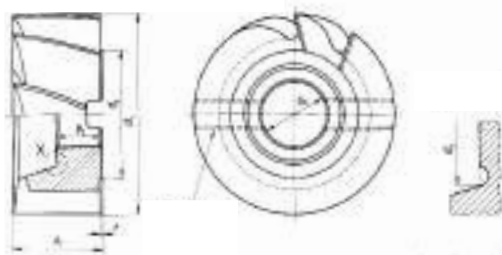

Series								SG125	SG126
Material								HSS	Co 5%
Form								F	F
								price EUR	
	d ₁	b ₁	b ₂	d ₂	d ₃	d ₄	t	each	each
	js16	k16	-1	H7	min.	min.	max.		
040032	40	32	19	16	23			68,800	86,000
050036	50	36	21	22	30			96,800	121,000
063040	63	40	23	27	38			141,600	177,000
080045	80	45	23	27	38	49	0,5	220,800	276,000
100050	100	50	26	32	45	59	0,5	343,200	429,000
125056	125	56	29	40	56	71	0,5	594,800	743,500
160063	160	63	32	50	67	91	0,5	1026,800	1283,500

*Posebno označene stavke (**bold**) odnose se na robu koju imamo na lageru. Za ostali asortiman rabate i rokove isporuke dajemo na osnovu upita.

*Items given in **bold** figures refer to products on stock. Discount and delivery terms for other product assortment are given at request.

*Die separat gekennzeichneten artikel (**bold**) beziehen sich auf die Ware, die auf Lager liegt. Die Rabatte und Lieferzeiten für das restliche Sortiment geben wir auf Anfrage bekannt.

ČEONA NASADNA GLODALA
SA UZDUŽNIM ŽLJEBOVIMA

SHELL END MILLS
WITH STANDARD KEYWAY

WALTZENSTIRNFRÄSER
MIT LÄNGSNUT

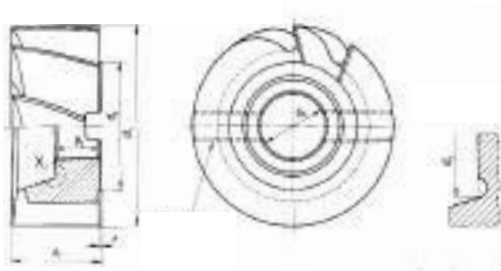

Series								SG127	SG128
	Material							HSS	Co 5%
	Form							N	N
	d ₁	b ₁	b ₂	d ₂	d ₃	d ₄	t	price EUR	
	js16	k16	-1	H7	min.	min.	max.	each	each
040032	40	32	19	16	23			57,200	71,500
050036	50	36	21	22	30			82,000	102,500
063040	63	40	23	27	38			124,000	155,000
080045	80	45	23	27	38	49	0,5	200,000	250,000
100050	100	50	26	32	45	59	0,5	320,000	400,000
125056	125	56	29	40	56	71	0,5	570,000	712,500
160063	160	63	32	50	67	91	0,5	986,000	1232,500

ČEONA NASADNA GLODALA
SA UZDUŽNIM ŽLJEBOVIMA, ZA TEŠKU OBRADU

SHELL END MILLS
WITH STANDARD KEYWAY, HEAVY-DUTY

WALTZENSTIRNFRÄSER
MIT LÄNGSNUT FÜR SCHWERE BEARBEITUNG

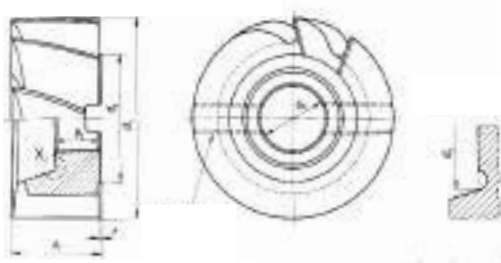

Series								SG129	SG130
	Material							HSS	Co 5%
	Form							F	F
	d ₁	b ₁	b ₂	d ₂	d ₃	d ₄	t	price EUR	
	js16	k16	-1	H7	min.	min.	max.	each	each
040032	40	32	19	16	23			67,600	84,500
050036	50	36	21	22	30			94,800	118,500
063040	63	40	23	27	38			140,000	175,000
080045	80	45	23	27	38	49	0,5	218,000	272,500
100050	100	50	26	32	45	59	0,5	340,800	426,000
125056	125	56	29	40	56	71	0,5	598,800	748,500
160063	160	63	32	50	67	91	0,5	1023,200	1279,000

*Posebno označene stavke (**bold**) odnose se na robu koju imamo na lageru. Za ostali asortiman rabate i rokove isporuke dajemo na osnovu upita.

*Items given in **bold** figures refer to products on stock. Discount and delivery terms for other product assortment are given at request.

*Die separat gekennzeichneten artikel (**bold**) beziehen sich auf die Ware, die auf Lager liegt. Die Rabatte und Lieferzeiten für das restliche Sortiment geben wir auf Anfrage bekannt.

**KOTURASTA GLODALA ZA ŽLJEBOVE,
SA PRAVIM PODSTRUGANIM ZUBIMA**

**SLOTING CUTTERS,
WITH STRAIGHT TEETH FORM-RELIEVED**

**NUTENFRÄSER,
GERADEVERZAHNT HINTERDREHT**



Series	Material				SG131	SG132
	Form				HSS	Co 5%
	d ₁	b	d ₂	d ₃	A	A
	js16	d9	H7	min.	price EUR	
					each	each
050004	50	4	16	27	36,800	46,000
050005	50	5	16	27	36,800	46,000
050006	50	6	16	27	38,400	48,000
050008	50	8	16	27	42,000	52,500
050010	50	10	16	27	45,600	57,000
063004	63	4	22	34	50,000	62,500
063005	63	5	22	34	50,000	62,500
063006	63	6	22	34	52,000	65,000
063008	63	8	22	34	56,800	71,000
063010	63	10	22	34	61,600	77,000
063012	63	12	22	34	67,200	84,000
063014	63	14	22	34	72,000	90,000
080005	80	5	27	41	68,000	85,000
080006	80	6	27	41	70,800	88,500
080008	80	8	27	41	77,200	96,500
080010	80	10	27	41	84,000	105,000
080012	80	12	27	41	91,600	114,500
080014	80	14	27	41	98,000	122,500
080016	80	16	27	41	106,800	133,500
080018	80	18	27	41	114,800	143,500
100006	100	6	32	47	95,600	119,500
100008	100	8	32	47	104,800	131,000
100010	100	10	32	47	113,600	142,000
100012	100	12	32	47	124,000	155,000
100014	100	14	32	47	132,800	166,000
100016	100	16	32	47	143,200	179,000
100018	100	18	32	47	154,400	193,000
100020	100	20	32	47	164,800	206,000
100022	100	22	32	47	174,800	218,500
100025	100	25	32	47	198,000	247,500

*Posebno označene stavke (**bold**) odnose se na robu koju imamo na lageru. Za ostali asortiman rabate i rokove isporuke dajemo na osnovu upita.

*Items given in **bold** figures refer to products on stock. Discount and delivery terms for other product assortment are given at request.

*Die separat gekennzeichneten artikel (**bold**) beziehen sich auf die Ware, die auf Lager liegt. Die Rabatte und Lieferzeiten für das restliche Sortiment geben wir auf Anfrage bekannt.

Series					SG131	SG132
	Material				HSS	Co 5%
	Form				A	A
	d ₁	b	d ₂	d ₃	price EUR	
js16	d9	H7	min.	each	each	
125008	125	8	32	47	157,200	196,500
125010	125	10	32	47	170,400	213,000
125012	125	12	32	47	186,000	232,500
125014	125	14	32	47	198,400	248,000
125016	125	16	32	47	214,800	268,500
125018	125	18	32	47	233,600	292,000
125020	125	20	32	47	250,800	313,500
125022	125	22	32	47	268,800	336,000
125025	125	25	32	47	296,800	371,000
160010	160	10	40	55	256,000	320,000
160012	160	12	40	55	279,200	349,000
160014	160	14	40	55	300,000	375,000
160016	160	16	40	55	328,000	410,000
160018	160	18	40	55	356,800	446,000
160020	160	20	40	55	383,200	479,000
160022	160	22	40	55	410,400	513,000
160025	160	25	40	55	453,200	566,500
160028	160	28	40	55	496,800	621,000
160032	160	32	40	55	540,000	675,000

*Posebno označene stavke (**bold**) odnose se na robu koju imamo na lageru. Za ostali asortiman rabate i rokove isporuke dajemo na osnovu upita.

*Items given in **bold** figures refer to products on stock. Discount and delivery terms for other product assortment are given at request.

*Die separat gekennzeichneten artikel (**bold**) beziehen sich auf die Ware, die auf Lager liegt. Die Rabatte und Lieferzeiten für das restliche Sortiment geben wir auf Anfrage bekannt.

**KOTURASTA GLODALA ZA ŹLJEBOVE
SA UKRŠTENIM PODSTRUGANIM ZUBIMA**

**SLOTING CUTTERS
WITH STAGGERD TEETH FORM-RELIEVED**

**NUTENFRÄSER
KREUZVERZAHNT HINTERDREHT**

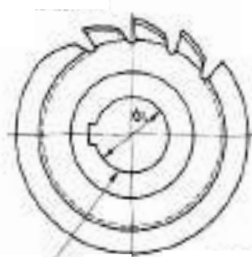

Series					SG133	SG134
	Material				HSS	Co 5%
	Form				B	B
	d ₁	b	d ₂	d ₃	price EUR	
	js16	d9	H7	min.	each	each
050004	50	4	16	27	33,600	42,000
050005	50	5	16	27	34,800	43,500
050006	50	6	16	27	36,400	45,500
050008	50	8	16	27	40,400	50,500
050010	50	10	16	27	44,000	55,000
063004	63	4	22	34	45,600	57,000
063005	63	5	22	34	48,000	60,000
063006	63	6	22	34	50,000	62,500
063008	63	8	22	34	54,800	68,500
063010	63	10	22	34	59,600	74,500
063012	63	12	22	34	76,800	96,000
063014	63	14	22	34	82,400	103,000
080005	80	5	27	41	62,000	77,500
080006	80	6	27	41	64,800	81,000
080008	80	8	27	41	70,800	88,500
080010	80	10	27	41	82,400	103,000
080012	80	12	27	41	88,800	111,000
080014	80	14	27	41	95,600	119,500
080016	80	16	27	41	104,800	131,000
080018	80	18	27	41	112,000	140,000
100006	100	6	32	47	82,800	103,500
100008	100	8	32	47	90,400	113,000
100010	100	10	32	47	105,200	131,500
100012	100	12	32	47	117,600	147,000
100014	100	14	32	47	129,600	162,000
100016	100	16	32	47	140,400	175,500
100018	100	18	32	47	151,200	189,000
100020	100	20	32	47	161,600	202,000
100022	100	22	32	47	172,000	215,000
100025	100	25	32	47	188,800	236,000

*Posebno označene stavke (**bold**) odnose se na robu koju imamo na lageru. Za ostali asortiman rabate i rokove isporuke dajemo na osnovu upita.

*Items given in **bold** figures refer to products on stock. Discount and delivery terms for other product assortment are given at request.

*Die separat gekennzeichneten artikel (**bold**) beziehen sich auf die Ware, die auf Lager liegt. Die Rabatte und Lieferzeiten für das restliche Sortiment geben wir auf Anfrage bekannt.

Series					SG133	SG134
	Material				HSS	Co 5%
	Form				B	B
	d ₁	b	d ₂	d ₃	price EUR	
js16	d9	H7	min.	each	each	
125008	125	8	32	47	133,600	167,000
125010	125	10	32	47	157,200	196,500
125012	125	12	32	47	176,000	220,000
125014	125	14	32	47	192,800	241,000
125016	125	16	32	47	210,400	263,000
125018	125	18	32	47	228,000	285,000
125020	125	20	32	47	245,200	306,500
125022	125	22	32	47	264,800	331,000
125025	125	25	32	47	290,800	363,500
160010	160	10	40	55	246,000	307,500
160012	160	12	40	55	275,600	344,500
160014	160	14	40	55	301,600	377,000
160016	160	16	40	55	331,200	414,000
160018	160	18	40	55	356,800	446,000
160020	160	20	40	55	384,000	480,000
160022	160	22	40	55	414,400	518,000
160025	160	25	40	55	455,200	569,000
160028	160	28	40	55	496,800	621,000
160032	160	32	40	55	540,000	675,000

*Posebno označene stavke (**bold**) odnose se na robu koju imamo na lageru. Za ostali asortiman rabate i rokove isporuke dajemo na osnovu upita.

*Items given in **bold** figures refer to products on stock. Discount and delivery terms for other product assortment are given at request.

*Die separat gekennzeichneten artikel (**bold**) beziehen sich auf die Ware, die auf Lager liegt. Die Rabatte und Lieferzeiten für das restliche Sortiment geben wir auf Anfrage bekannt.

ČETVEROKRUŽNA UDUBLJENA GLODALA

CORNER ROUNDING CUTTERS

VIERTEILRUND PROFILFRÄSER (KONKAV)

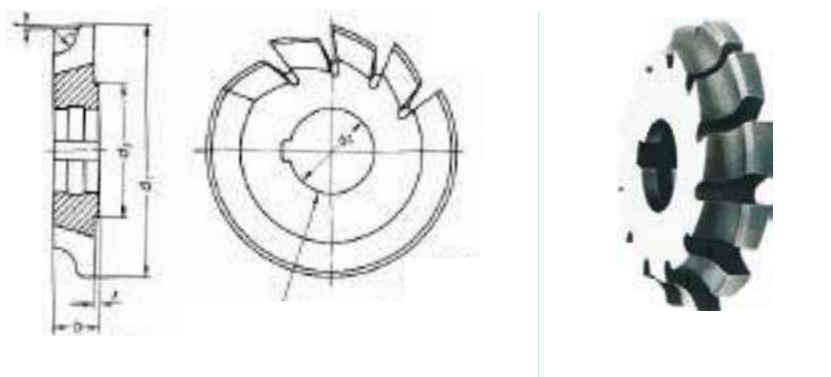

Series	Material							SG137	SG138
								HSS	Co 5%
	r	d ₁	d ₂	d ₃	b	f	t	price EUR	
	h11	js16	H7					each	each
100050	1	50	16		4	0,2		32,400	40,500
125050	1,25	50	16		4	0,2		33,000	41,250
160050	1,6	50	16		5	0,25		35,880	44,850
200050	2	50	16		5	0,25		36,400	45,500
250063	2,5	63	22		5	0,3		42,680	53,350
300063	3	63	22		6	0,3		47,640	59,550
315063	3,15	63	22		6	0,3		49,000	61,250
400063	4	63	22		8	0,4		56,840	71,050
500063	5	63	22		10	0,5		63,200	79,000
600080	6	80	27	41	12	0,6	0,5	89,400	111,750
630080	6,3	80	27	41	12	0,6	0,5	93,800	117,250
800080	8	80	27	41	16	0,8	0,5	113,480	141,850
100100	10	100	32	47	18	1	0,5	169,800	212,250
120100	12	100	32	47	20	1,2	0,5	192,080	240,100
125100	12,5	100	32	47	20	1,2	0,5	195,400	244,250
160125	16	125	32	47	24	1,6	0,5	305,920	382,400
200125	20	125	32	47	28	2	0,5	352,600	440,750

*Posebno označene stavke (**bold**) odnose se na robu koju imamo na lageru. Za ostali asortiman rabate i rokove isporuke dajemo na osnovu upita.

*Items given in **bold** figures refer to products on stock. Discount and delivery terms for other product assortment are given at request.

*Die separat gekennzeichneten artikel (**bold**) beziehen sich auf die Ware, die auf Lager liegt. Die Rabatte und Lieferzeiten für das restliche Sortiment geben wir auf Anfrage bekannt.

PROBIJAČI RUPA SA ZAVRTNJEM, SA 3 REZNA VRHA

SCREW HOLE - PUNCHES, WITH 3 POINT CUTTING

SCHRAUBLOCHSTANZEN, MIT 3 PUNKT ANCHNITT



Series					SG181	SG182
	Material				Spec. steel	Spec. steel
	Type				A	B
					Standard	Ball-bearing
	Ø	Pg	Screw	Metal sheet	price EUR	
	mm		MF	max.mm	each	each
000127	12,7	7	8x1	1,5	12,400	20,000
000130	13	-	8x1	1,5	12,800	20,400
000140	14	-	8x1	1,5	13,200	20,800
000150	15	-	8x1	1,5	13,200	20,800
000152	15,2	9	10x1	1,5	13,200	20,800
000160	16	-	10x1	2	13,200	20,800
000165	16,5	-	10x1	2	13,200	20,800
000170	17	-	10x1	2	13,200	20,800
000180	18	-	10x1	2	13,600	21,200
000186	18,6	11	10x1	2	14,400	22,000
000190	19	-	10x1	2	14,400	22,000
000200	20	-	10x1	2	14,400	22,000
000204	20,4	13,5	10x1	2	14,800	22,400
000210	21	-	10x1	2	14,800	22,400
000220	22	-	10x1	2	15,200	22,800
000225	22,5	16	10x1	2	15,200	22,800
000230	23	-	10x1	2	15,200	22,800
000240	24	-	10x1	2	15,200	22,800
000250	25	-	10x1	2	16,000	23,600
000254	25,4	-	10x1	2	16,000	23,600
000260	26	-	10x1	2	16,000	23,600
000270	27	-	10x1	2	16,000	23,600
000280	28	-	12x1,5	2	16,400	24,000
000283	28,3	21	12x1,5	2	16,400	24,000
000290	29	-	12x1,5	2	16,400	24,000
000300	30	-	12x1,5	2	17,200	24,800
000305	30,5	-	12x1,5	2	17,200	24,800
000310	31	-	12x1,5	2	17,200	24,800
000320	32	-	12x1,5	2	18,400	26,000
000325	32,5	-	12x1,5	2	18,400	26,000
000330	33	-	12x1,5	2	18,800	26,400
000340	34	-	12x1,5	2	19,600	27,200
000350	35	-	12x1,5	2	20,400	28,000
000360	36	-	12x1,5	2	20,400	28,000
000370	37	29	12x1,5	2	20,800	28,400
000380	38	-	12x1,5	2	21,200	28,800
000390	39	-	12x1,5	2	22,400	30,000
000400	40	-	12x1,5	2	22,400	30,000

*Posebno označene stavke (**bold**) odnose se na robu koju imamo na lageru. Za ostali asortiman rabate i rokove isporuke dajemo na osnovu upita.

*Items given in **bold** figures refer to products on stock. Discount and delivery terms for other product assortment are given at request.

*Die separat gekennzeichneten artikel (**bold**) beziehen sich auf die Ware, die auf Lager liegt. Die Rabatte und Lieferzeiten für das restliche Sortiment geben wir auf Anfrage bekannt.

Series					SG181	SG182
	Material				Spec. steel	Spec. steel
	Type				A	B
					Standard	Ball-bearing
	Ø	Pg	Screw	Metal sheet	price EUR	
	mm		MF	max.mm	each	each
000405	40,5	-	16x1,5	2	22,400	30,000
000410	41	-	16x1,5	2	23,200	30,800
000420	42	-	16x1,5	2	23,200	30,800
000430	43	-	16x1,5	2	23,200	30,800
000440	44	-	16x1,5	2	24,000	31,600
000450	45	-	16x1,5	2	24,000	31,600
000460	46	-	16x1,5	2	24,000	31,600
000470	47	36	16x1,5	2	27,200	34,800
000480	48	-	16x1,5	2	27,200	34,800
000490	49	-	16x1,5	2	27,200	34,800
000500	50	-	16x1,5	2	28,000	35,600
000505	50,5	-	16x1,5	3	30,000	37,600
000510	51	-	16x1,5	3	31,600	39,200
000520	52	-	16x1,5	3	32,000	39,600
000525	52,5	-	16x1,5	3	33,600	41,200
000530	53	-	16x1,5	3	33,600	41,200
000540	54	42	16x1,5	3	36,800	44,400
000550	55	-	16x1,5	3	38,000	45,600
000560	56	-	16x1,5	3	40,000	47,600
000570	57	-	16x1,5	3	40,000	47,600
000580	58	-	16x1,5	3	40,000	47,600
000590	59	-	16x1,5	3	40,000	47,600
000600	60	48	16x1,5	3	40,000	47,600
000605	60,5	-	16x1,5	3	42,000	49,600
000610	61	-	16x1,5	3		
000620	62	-	16x1,5	3		
000630	63	-	16x1,5	3		
000635	63,5	-	16x1,5	3		
000640	64	-	20x1,5	3		
000650	65	-	20x1,5	3		
000700	70	-	20x1,5	3		
000730	73	-	20x1,5	3,5		
000750	75	-	20x1,5	3,5		
000800	80	-	20x1,5	3,5		
000850	85	-	20x1,5	3,5		
000890	89	-	24x1,5	3,5		
001020	102	-	24x1,5	3,5		
001150	115	-	24x1,5	3,5		

*Posebno označene stavke (**bold**) odnose se na robu koju imamo na lageru. Za ostali asortiman rabate i rokove isporuke dajemo na osnovu upita.

*Items given in **bold** figures refer to products on stock. Discount and delivery terms for other product assortment are given at request.

*Die separat gekennzeichneten artikel (**bold**) beziehen sich auf die Ware, die auf Lager liegt. Die Rabatte und Lieferzeiten für das restliche Sortiment geben wir auf Anfrage bekannt.

RAZVRTAČI RUČNI, VALJKASTA DRŠKA

HAND REAMERS, STRAIGHT SHANK

HANDREIBAHLEN, ZYLINDERSCHAFT

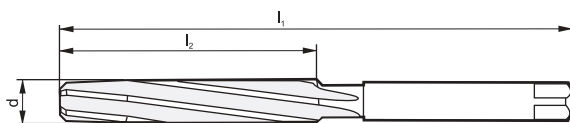

Series				SR01	SR02	SR03	SR04
	Material			HSS	Co 5%	HSS	Co 5%
	Type			A	A	B	B
	d	l ₁	l ₂	price EUR			
mm	mm	mm	each	each	each	each	
00200	2	50	25	9,380	14,070	9,380	14,070
00220	2,2	54	27	10,570	15,862	10,570	15,862
00250	2,5	58	29	9,660	14,490	9,660	14,490
00280	2,8	62	31	11,410	17,122	11,410	17,122
00300	3	62	31	10,500	15,750	10,500	15,750
00320	3,2	66	33	10,920	16,380	10,920	16,380
00350	3,5	71	35	10,920	16,380	10,920	16,380
00400	4	76	38	10,920	16,380	10,920	16,380
00450	4,5	81	41	12,530	18,802	12,530	18,802
00500	5	87	44	12,250	18,382	12,250	18,382
00550	5,5	93	47	13,580	20,370	13,580	20,370
00600	6	93	47	12,670	19,012	12,670	19,012
00700	7	107	54	13,580	20,370	13,580	20,370
00800	8	115	58	14,420	21,630	14,420	21,630
00900	9	124	62	16,170	24,262	16,170	24,262
01000	10	133	66	16,800	25,200	16,800	25,200
01100	11	142	71	17,920	26,880	17,920	26,880
01200	12	152	76	19,670	29,512	19,670	29,512
01300	13	152	76	24,480	36,720	24,480	36,720
01400	14	163	81	27,520	41,280	27,520	41,280
01500	15	163	81	30,000	45,008	30,000	45,008
01600	16	175	87	32,000	48,000	32,000	48,000
01700	17	175	87	34,960	52,448	34,960	52,448
01800	18	188	93	37,040	55,568	37,040	55,568
01900	19	188	93	43,520	65,280	43,520	65,280
02000	20	201	100	44,000	66,000	44,000	66,000
02200	22	215	107	50,000	75,008	50,000	75,008
02400	24	231	115	61,040	91,568	61,040	91,568
02500	25	231	115	63,040	94,560	63,040	94,560
02600	26	231	115	69,040	103,568	69,040	103,568

*Posebno označene stavke (**bold**) odnose se na robu koju imamo na lageru. Za ostali asortiman rabate i rokove isporuke dajemo na osnovu upita.

*Items given in **bold** figures refer to products on stock. Discount and delivery terms for other product assortment are given at request.

*Die separat gekennzeichneten artikel (**bold**) beziehen sich auf die Ware, die auf Lager liegt. Die Rabatte und Lieferzeiten für das restliche Sortiment geben wir auf Anfrage bekannt.

Series				SR01	SR02	SR03	SR04
	Material			HSS	Co 5%	HSS	Co 5%
	Type			A	A	B	B
	d	l ₁	l ₂	price EUR			
mm	mm	mm	each	each	each	each	
02800	28	247	124	78,000	117,008	78,000	117,008
03000	30	247	124	85,040	127,568	85,040	127,568
03200	32	265	133	100,000	150,000	100,000	150,000
03400	34	284	142	130,000	195,008	130,000	195,008
03500	35	284	142	124,000	186,000	124,000	186,000
03600	36	284	142	145,040	217,568	145,040	217,568
03800	38	305	152	160,000	240,000	160,000	240,000
04000	40	305	152	160,000	240,000	160,000	240,000
04200	42	305	152	192,800	289,200	192,800	289,200
04400	44	326	163	245,600	368,400	245,600	368,400
04500	45	326	163	224,800	337,200	224,800	337,200
04600	46	326	163	296,800	445,200	296,800	445,200
04800	48	347	174	317,600	476,400	317,600	476,400
05000	50	347	174	284,800	427,200	284,800	427,200

*Posebno označene stavke (**bold**) odnose se na robu koju imamo na lageru. Za ostali asortiman rabate i rokove isporuke dajemo na osnovu upita.

*Items given in **bold** figures refer to products on stock. Discount and delivery terms for other product assortment are given at request.

*Die separat gekennzeichneten artikel (**bold**) beziehen sich auf die Ware, die auf Lager liegt. Die Rabatte und Lieferzeiten für das restliche Sortiment geben wir auf Anfrage bekannt.

RAZVRTAČI MAŠNSKI, MK DRŠKA

MACHINE REAMERS, MORSE TAPER SHANK

MASCHINENREIBAHLEN, MORSEKEGELSCHAFT

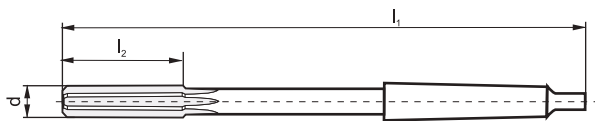

Series					SR11	SR12	SR13	SR14
	Material				HSS	Co 5%	HSS	Co 5%
	Type				A	A	B	B
	d	l ₁	l ₂	MT	price EUR			
mm	mm	mm	each		each	each	each	
00300	3	125	20	1	22,000	33,008	22,000	33,008
00400	4	133	22	1	21,680	33,008	21,680	33,008
00500	5	133	23	1	22,480	33,728	22,480	33,728
00600	6	138	26	1	23,520	34,560	23,520	34,560
00700	7	150	31	1	23,520	35,280	23,520	35,280
00800	8	156	33	1	23,520	35,280	23,520	35,280
00900	9	162	36	1	26,480	39,728	26,480	39,728
01000	10	168	38	1	25,040	37,568	25,040	37,568
01100	11	175	41	1	26,480	39,728	26,480	39,728
01200	12	182	44	1	26,480	39,728	26,480	39,728
01300	13	182	44	1	27,680	42,720	27,680	42,720
01400	14	189	47	1	28,000	43,008	28,000	43,008
01500	15	204	50	2	28,960	43,440	28,960	43,440
01600	16	210	52	2	31,520	47,280	31,520	47,280
01700	17	214	54	2	34,000	51,008	34,000	51,008
01800	18	219	56	2	35,008	52,496	35,008	52,496
01900	19	223	58	2	38,480	57,728	38,480	57,728
02000	20	228	60	2	38,480	57,728	38,480	57,728
02100	21	232	62	2	44,480	66,720	44,480	66,720
02200	22	237	64	2	44,000	66,000	44,000	66,000
02300	23	241	66	2	49,520	74,288	49,520	74,288
02400	24	268	68	3	51,040	76,560	51,040	76,560
02500	25	268	68	3	52,960	79,440	52,960	79,440
02600	26	273	70	3	58,960	88,448	58,960	88,448
02700	27	277	71	3	66,960	100,448	66,960	100,448
02800	28	277	71	3	62,960	94,448	62,960	94,448
02900	29	281	73	3	72,960	109,440	72,960	109,440
03000	30	281	73	3	72,000	108,000	72,000	108,000
03100	31	285	75	3	84,960	127,440	84,960	127,440
03200	32	317	77	4	86,000	129,008	86,000	129,008

*Posebno označene stavke (**bold**) odnose se na robu koju imamo na lageru. Za ostali asortiman rabate i rokove isporuke dajemo na osnovu upita.

*Items given in **bold** figures refer to products on stock. Discount and delivery terms for other product assortment are given at request.

*Die separat gekennzeichneten artikel (**bold**) beziehen sich auf die Ware, die auf Lager liegt. Die Rabatte und Lieferzeiten für das restliche Sortiment geben wir auf Anfrage bekannt.

Series					SR11	SR12	SR13	SR14
	Material				HSS	Co 5%	HSS	Co 5%
	Type				A	A	B	B
	d	l ₁	l ₂	MT	price EUR			
mm	mm	mm	each		each	each	each	
03300	33	317	77	4	104,960	157,440	104,960	157,440
03400	34	321	78	4	104,000	156,000	104,000	156,000
03500	35	321	78	4	104,000	156,000	104,000	156,000
03600	36	325	79	4	114,000	171,008	114,000	171,008
03800	38	329	81	4	127,040	190,560	127,040	190,560
04000	40	329	81	4	132,000	198,000	132,000	198,000
04200	42	333	82	4	140,000	210,000	140,000	210,000
04400	44	336	83	4	170,000	255,008	170,000	255,008
04500	45	336	83	4	161,040	241,568	161,040	241,568
04600	46	340	84	4	173,040	259,568	173,040	259,568
04700	47	340	84	4	208,000	312,000	208,000	312,000
04800	48	344	86	4	190,000	285,008	190,000	285,008
05000	50	344	86	4	205,040	307,568	205,040	307,568

*Posebno označene stavke (**bold**) odnose se na robu koju imamo na lageru. Za ostali asortiman rabate i rokove isporuke dajemo na osnovu upita.

*Items given in **bold** figures refer to products on stock. Discount and delivery terms for other product assortment are given at request.

*Die separat gekennzeichneten artikel (**bold**) beziehen sich auf die Ware, die auf Lager liegt. Die Rabatte und Lieferzeiten für das restliche Sortiment geben wir auf Anfrage bekannt.

RAZVRTAČI MAŠINSKI, VALJKASTA DRŠKA

MACHINE REAMERS, STRAIGHT SHANK

MASCHINENREIBAHLEN, ZYLINDERSCHAFT

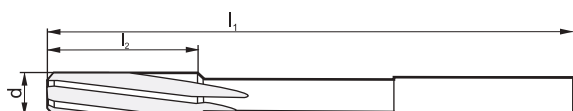

Series	Material			SR21	SR22	SR23	SR24
	Type			HSS	Co 5%	HSS	Co 5%
	d	l ₁	l ₂	C	C	D	D
	mm	mm	mm	price EUR			
				each	each	each	each
00200	2	49	11	8,880	13,328	8,880	13,328
00220	2,2	53	12	9,920	14,880	9,920	14,880
00250	2,5	57	14	9,280	13,920	9,280	13,920
00280	2,8	61	15	10,080	15,120	10,080	15,120
00300	3	61	15	9,040	13,568	9,040	13,568
00320	3,2	65	16	10,000	15,008	10,000	15,008
00350	3,5	70	18	10,000	15,008	10,000	15,008
00400	4	75	19	10,240	15,360	10,240	15,360
00450	4,5	80	21	10,800	16,208	10,800	16,208
00500	5	86	23	10,880	16,320	10,880	16,320
00550	5,5	93	26	11,520	17,280	11,520	17,280
00600	6	93	26	11,520	17,280	11,520	17,280
00650	6,5	101	28	13,040	19,568	13,040	19,568
00700	7	109	31	13,040	19,568	13,040	19,568
00800	8	117	33	14,240	21,360	14,240	21,360
00900	9	125	36	16,480	24,720	16,480	24,720
01000	10	133	38	18,000	27,008	18,000	27,008
01100	11	142	41	22,480	33,728	22,480	33,728
01200	12	151	44	23,040	34,560	23,040	34,560
01300	13	151	44	25,040	37,568	25,040	37,568
01400	14	160	47	27,040	40,560	27,040	40,560
01500	15	162	50	28,000	42,000	28,000	42,000
01600	16	170	52	30,000	45,008	30,000	45,008
01700	17	175	54	34,000	51,008	34,000	51,008
01800	18	182	56	35,040	52,560	35,040	52,560
01900	19	189	58	42,000	63,008	42,000	63,008
02000	20	195	60	40,000	60,000	40,000	60,000
02100	21	215	55	59,040	88,560	59,040	88,560
02200	22	225	55	54,000	81,008	54,000	81,008
02300	23	230	60	66,000	99,008	66,000	99,008
02400	24	240	60	61,040	91,568	61,040	91,568
02500	25	245	60	62,000	93,008	62,000	93,008
02600	26	250	60	72,000	108,000	72,000	108,000
02700	27	260	60	87,040	130,560	87,040	130,560
02800	28	270	65	89,040	133,568	89,040	133,568
02900	29	270	65	106,000	159,008	106,000	159,008
03000	30	280	70	104,000	156,000	104,000	156,000
03100	31	290	75	126,000	189,008	126,000	189,008

*Posebno označene stavke (**bold**) odnose se na robu koju imamo na lageru. Za ostali asortiman rabate i rokove isporuke dajemo na osnovu upita.

*Items given in **bold** figures refer to products on stock. Discount and delivery terms for other product assortment are given at request.

*Die separat gekennzeichneten artikel (**bold**) beziehen sich auf die Ware, die auf Lager liegt. Die Rabatte und Lieferzeiten für das restliche Sortiment geben wir auf Anfrage bekannt.

RAZVRTAČI ZA RUPE ZAKIVAKA, MT DRŠKA

BRIDGE REAMERS, MORSE TAPER SHANK

NIETLOCHREIBAHLEN, MORSEKEGELSCHAFT

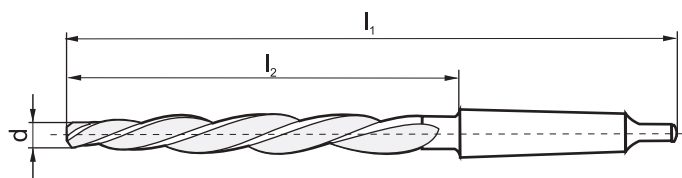

Series	Material				SR37	SR38
	Type				HSS	Co 5%
	d	l ₁	l ₂	MT	B	B
	mm	mm	mm		price EUR	
					each	each
00640	6,4	151	75	1	42,552	63,828
00740	7,4	156	80	1	42,552	63,828
00840	8,4	161	85	1	42,552	63,828
00950	9,5	166	90	1	42,552	63,828
01000	10	171	95	1	42,552	63,828
01100	11	176	100	1	42,552	63,828
01200	12	199	105	2	43,200	64,800
01300	13	199	105	2	43,200	64,800
01400	14	209	115	2	47,995	71,928
01500	15	219	125	2	47,088	70,632
01600	16	229	135	2	54,000	81,000
01700	17	238	135	2	58,104	87,156
01800	18	261	145	3	63,504	95,256
01900	19	261	145	3	66,204	99,306
02000	20	271	155	3	71,604	107,406
02100	21	271	155	3	74,304	111,456
02200	22	281	165	3	82,404	123,606
02300	23	281	165	3	85,104	127,656
02400	24	296	180	3	89,100	133,650
02500	25	296	180	3	91,800	137,700
02600	26	296	180	3	104,004	156,006
02700	27	311	195	3	114,804	172,206
02800	28	311	195	3	122,904	184,356
02900	29	311	195	3	141,804	212,706
03000	30	311	195	3	147,204	220,806
03100	31	326	210	3	168,804	253,206
03200	32	354	210	4	178,200	267,300
03300	33	354	210	4	189,000	283,500
03400	34	364	220	4	199,800	299,700
03600	36	364	220	4	221,400	332,100
03700	37	364	220	4	229,500	344,250
04000	40	374	230	4	263,304	394,956

*Posebno označene stavke (**bold**) odnose se na robu koju imamo na lageru. Za ostali asortiman rabate i rokove isporuke dajemo na osnovu upita.

*Items given in **bold** figures refer to products on stock. Discount and delivery terms for other product assortment are given at request.

*Die separat gekennzeichneten artikel (**bold**) beziehen sich auf die Ware, die auf Lager liegt. Die Rabatte und Lieferzeiten für das restliche Sortiment geben wir auf Anfrage bekannt.

RAZVRTAČI KUPASTI 1:50, VALJKASTA DRŠKA

HAND TAPER PIN REAMERS, TAPER 1:50 STRAIGHT SHANK

HAND-KEGELREIBAHLEN, KEGEL 1:50, ZYLINDERSCHAFT



Series						SR31	SR32	SR33	SR34
	Material					HSS	Co 5%	HSS	Co 5%
	Type					A	A	B	B
	d ₁	l ₁	l ₂	d ₂	d ₃	price EUR			
	mm	mm	mm	mm	mm	each	each	each	each
00300	3	80	58	2,9	4,06	12,600	18,900	12,600	18,900
00400	4	93	68	3,9	5,26	13,776	20,664	13,776	20,664
00500	5	100	73	4,9	6,36	17,892	26,838	17,892	26,838
00600	6	135	105	5,9	8,00	22,092	33,138	22,092	33,138
00650	6,5	148	118	6,4	8,76	23,604	35,406	23,604	35,406
00700	7	160	130	6,9	9,50	29,904	44,856	29,904	44,856
00800	8	180	145	7,9	10,80	36,204	54,306	36,204	54,306
00900	9	190	152	8,9	11,94	43,596	65,394	43,596	65,394
01000	10	215	175	9,9	13,40	44,604	66,906	44,604	66,906
01200	12	255	210	11,8	16,00	63,000	94,500	63,000	94,500
01300	13	255	210	12,8	17,00	81,600	122,400	81,600	122,400
01400	14	255	210	13,8	18,00	84,000	126,000	84,000	126,000
01600	16	280	230	15,8	20,40	104,400	156,608	104,400	156,608
02000	20	310	250	19,8	24,80	132,000	198,000	132,000	198,000
02500	25	370	300	24,7	30,70	226,800	340,200	226,800	340,200
03000	30	400	320	29,7	36,10	286,200	429,300	286,200	429,300
04000	40	430	340	39,7	46,50	462,024	693,036	462,024	693,036
05000	50	460	360	49,7	56,90	788,400	1182,600	788,400	1182,600

*Posebno označene stavke (**bold**) odnose se na robu koju imamo na lageru. Za ostali asortiman rabate i rokove isporuke dajemo na osnovu upita.

*Items given in **bold** figures refer to products on stock. Discount and delivery terms for other product assortment are given at request.

*Die separat gekennzeichneten artikel (**bold**) beziehen sich auf die Ware, die auf Lager liegt. Die Rabatte und Lieferzeiten für das restliche Sortiment geben wir auf Anfrage bekannt.

RAZVRTAČI MAŠINSKI, NASADNI

SHELL REAMERS

AUFSTECK - REIBAHLEN

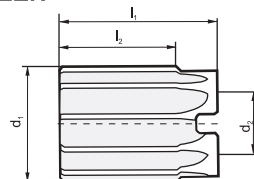

Series					SR91	SR92	SR93	SR94
	Material				HSS	Co 5%	HSS	Co 5%
	Type				A	A	B	B
	d ₁	l ₁	l ₂	d ₂	price EUR			
	mm	mm	mm	mm	each	each	each	each
02500	25	45	32	13	63,040	94,560	63,040	94,560
02600	26	45	32	13	66,400	99,600	66,400	99,600
02700	27	45	32	13	75,040	112,560	75,040	112,560
02800	28	45	32	13	68,000	102,000	68,000	102,000
02900	29	45	32	13	75,040	112,560	75,040	112,560
03000	30	45	32	13	69,040	103,568	69,040	103,568
03100	31	50	36	16	85,040	127,568	85,040	127,568
03200	32	50	36	16	75,040	112,560	75,040	112,560
03300	33	50	36	16	81,008	121,504	81,008	121,504
03400	34	50	36	16	81,008	121,504	81,008	121,504
03500	35	50	36	16	80,000	120,000	80,000	120,000
03600	36	56	40	19	88,000	132,000	88,000	132,000
03700	37	56	40	19	102,000	153,008	102,000	153,008
03800	38	56	40	19	96,000	144,000	96,000	144,000
04000	40	56	40	19	96,000	144,000	96,000	144,000
04200	42	56	40	19	102,000	153,008	102,000	153,008
04400	44	63	45	22	129,008	193,504	129,008	193,504
04500	45	63	45	22	123,008	184,496	123,008	184,496
04600	46	63	45	22	136,000	204,000	136,000	204,000
04700	47	63	45	22	137,600	206,400	137,600	206,400
04800	48	63	45	22	138,000	207,008	138,000	207,008
05000	50	63	45	22	138,000	207,008	138,000	207,008
05200	52	71	50	27	165,040	247,568	165,040	247,568
05500	55	71	50	27	168,000	252,000	168,000	252,000
05800	58	71	50	27	190,000	285,008	190,000	285,008
06000	60	71	50	27	190,000	285,008	190,000	285,008
06200	62	80	56	32	228,000	342,000	228,000	342,000
06500	65	80	56	32	232,000	348,000	232,000	348,000
06800	68	80	56	32	285,040	427,568	285,040	427,568
07000	70	80	56	32	274,000	411,008	274,000	411,008
07200	72	90	63	40	311,840	467,760	311,840	467,760
07500	75	90	63	40	329,040	493,568	329,040	493,568
07800	78	90	63	40	432,000	648,000	432,000	648,000
08000	80	90	63	40	393,040	589,568	393,040	589,568
08200	82	90	63	40	460,000	690,000	460,000	690,000
08500	85	90	63	40	460,000	690,000	460,000	690,000
08800	88	100	71	50	470,000	705,008	470,000	705,008
09000	90	100	71	50	500,000	750,000	500,000	750,000
09200	92	100	71	50	670,000	1005,008	670,000	1005,008
09500	95	100	71	50	670,000	1005,008	670,000	1005,008
09800	98	100	71	50	680,000	1020,000	680,000	1020,000
10000	100	100	71	50	690,000	1035,008	690,000	1035,008

*Posebno označene stavke (**bold**) odnose se na robu koju imamo na lageru. Za ostali asortiman rabate i rokove isporuke dajemo na osnovu upita.

*Items given in **bold** figures refer to products on stock. Discount and delivery terms for other product assortment are given at request.

*Die separat gekennzeichneten artikel (**bold**) beziehen sich auf die Ware, die auf Lager liegt. Die Rabatte und Lieferzeiten für das restliche Sortiment geben wir auf Anfrage bekannt.

UPUŠTAČI SPIRALNI, MK DRŠKA

CORE DRILLS, MORSE TAPER SHANK

AUFBOHRER, MORSEKEGELSCHAFT

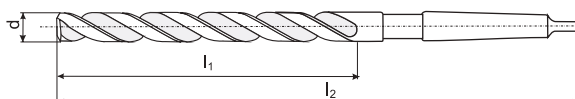

Series	Material			SU06	SU07
	d	l ₁	l ₂	HSS	Co 5%
	mm	mm	mm	price EUR	
00800	8	156	75	28,224	36,688
00900	9	162	81	33,024	42,928
01000	10	168	87	33,024	42,928
01100	11	175	94	33,600	43,680
01200	12	182	101	34,176	44,432
01300	13	182	101	36,576	47,552
01400	14	189	108	38,400	49,920
01500	15	212	114	39,648	51,536
01600	16	218	120	43,776	56,912
01700	17	223	125	45,600	59,280
01800	18	228	130	48,000	62,400
01900	19	233	135	52,800	68,640
02000	20	238	140	54,624	71,008
02100	21	243	145	60,000	78,000
02200	22	248	150	63,648	82,736
02300	23	253	155	70,848	92,096
02400	24	281	160	74,400	96,720
02500	25	281	160	79,200	102,960
02600	26	286	165	91,200	118,560
02700	27	291	170	97,248	126,416
02800	28	291	170	100,800	131,040
02900	29	296	175	109,248	142,016
03000	30	296	175	112,800	146,640
03100	31	301	180	130,848	170,096
03200	32	334	185	153,600	199,680
03300	33	334	185	153,600	199,680
03400	34	339	190	157,248	204,416
03500	35	339	190	159,648	207,536
03600	36	344	195	172,800	224,640
03700	37	344	195	187,200	243,360
03800	38	349	200	189,600	246,480

*Posebno označene stavke (**bold**) odnose se na robu koju imamo na lageru. Za ostali asortiman rabate i rokove isporuke dajemo na osnovu upita.

*Items given in **bold** figures refer to products on stock. Discount and delivery terms for other product assortment are given at request.

*Die separat gekennzeichneten artikel (**bold**) beziehen sich auf die Ware, die auf Lager liegt. Die Rabatte und Lieferzeiten für das restliche Sortiment geben wir auf Anfrage bekannt.

UPUŠTAČI ČEONI SA KRUTOM VOĐICOM, VALJKASTA DRŠKA

COUNTERBORES WITH SOLID PILOT, STRAIGHT SHANK

FLACHSENKER MIT FESTEM FÜHRUNG SZAPFEN, ZYLINDERSCHAFT

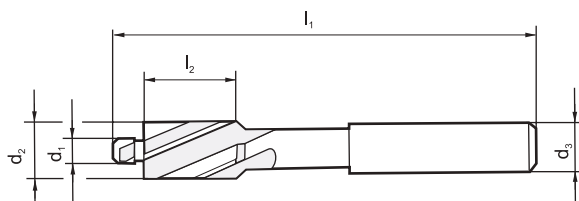

Series	Material						SU01	SU02	
		for thread	d ₂	l ₁	l ₂	d ₁	d ₃	price EUR	
			mm	mm	mm	mm	mm	each	each
FINE									
F0300	M3	6	71	14	3,2	5	12,000	16,800	
F0400	M4	8	71	14	4,3	5	12,000	16,800	
F0500	M5	10	80	18	5,3	8	12,000	16,800	
F0600	M6	11	80	18	6,4	8	13,020	18,228	
F0800	M8	15	100	22	8,4	12,5	20,860	29,204	
F1000	M10	18	100	22	10,5	12,5	26,000	36,400	
F1200	M12	20	100	22	13	12,5	30,000	42,000	
MEDIUM									
M0300	M3	6	71	14	3,4	5	12,000	16,800	
M0400	M4	8	71	14	4,5	5	12,000	16,800	
M0500	M5	10	80	18	5,5	8	12,000	16,800	
M0600	M6	11	80	18	6,6	8	13,020	18,228	
M0800	M8	15	100	22	9	12,5	20,860	29,204	
M1000	M10	18	100	22	11	12,5	26,000	36,400	
M1200	M12	20	100	22	14	12	30,000	42,000	
CORE HOLE									
C0300	M3	6	71	14	2,5	5	12,000	16,800	
C0400	M4	8	71	14	3,3	5	12,000	16,800	
C0500	M5	10	80	18	4,2	8	12,000	16,800	
C0600	M6	11	80	18	5	8	13,020	18,228	
C0800	M8	15	100	22	6,8	12,5	20,860	29,204	
C1000	M10	18	100	22	8,5	12,5	26,000	36,400	
C1200	M12	20	100	22	10,2	12,5	30,000	42,000	

*Posebno označene stavke (**bold**) odnose se na robu koju imamo na lageru. Za ostali asortiman rabate i rokove isporuke dajemo na osnovu upita.

*Items given in **bold** figures refer to products on stock. Discount and delivery terms for other product assortment are given at request.

*Die separat gekennzeichneten artikel (**bold**) beziehen sich auf die Ware, die auf Lager liegt. Die Rabatte und Lieferzeiten für das restliche Sortiment geben wir auf Anfrage bekannt.

UPUŠTAČI ČEONI SA KRUTOM VOĐICOM, MK DRŠKA

COUNTERBORES WITH SOLID PILOT, MORSE TAPER SHANK

FLACHSENKER MIT FESTEM FÜHRUNGZAPFEN, MORSEKEGELSCHAFT

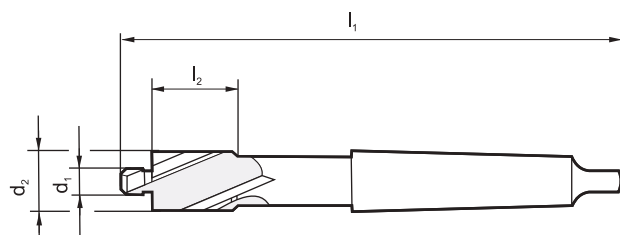

Series	Material					SU03	SU04
	for thread	d ₂	d ₁	l ₁	MT	HSS	Co 5%
		mm	mm	mm		price EUR	
						each	each
FINE							
F1000	M10	18	10.5	150	2	56,640	70,800
F1200	M12	20	13	150	2	59,328	74,160
F1400	M14	24	15	160	2	70,512	88,152
F1600	M16	26	17	190	3	82,128	102,672
F1800	M18	30	19	190	3	98,400	123,000
F2000	M20	33	21	190	3	110,400	138,000
F2200	M22	36	23	205	3	146,400	183,000
MEDIUM							
M1000	M10	18	11	150	2	56,640	70,800
M1200	M12	20	14	150	2	59,328	74,160
M1400	M14	24	16	160	2	70,512	88,152
M1600	M16	26	17.5	190	3	82,128	102,672
M1800	M18	30	20	190	3	98,400	123,000
M2000	M20	33	22	190	3	110,400	138,000
M2200	M22	36	24	205	3	146,400	183,000
CORE HOLE							
C1000	M10	18	8.5	150	2	56,640	70,800
C1200	M12	20	10.2	150	2	59,328	74,160
C1400	M14	24	12	160	2	70,512	88,152
C1600	M16	26	14	190	3	82,128	102,672
C1800	M18	30	15.5	190	3	98,400	123,000
C2000	M20	33	17.5	190	3	110,400	138,000
C2200	M22	36	19.5	205	3	146,400	183,000

*Posebno označene stavke (**bold**) odnose se na robu koju imamo na lageru. Za ostali asortiman rabate i rokove isporuke dajemo na osnovu upita.

*Items given in **bold** figures refer to products on stock. Discount and delivery terms for other product assortment are given at request.

*Die separat gekennzeichneten artikel (**bold**) beziehen sich auf die Ware, die auf Lager liegt. Die Rabatte und Liferzeiten für das restliche Sortiment geben wir auf Anfrage bekannt.

UPUŠTAČI KUPASTI SA RUPOM 90°

DEBURRING TOOLS 90°

ENGRATSENKER 90°

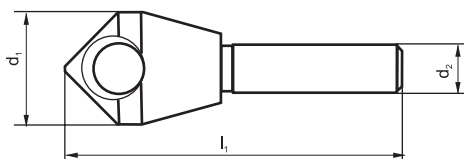

Series					SU61	SU62
	Material				HSS	Co 5%
	N ₀	d ₁ mm	l ₁ mm	d ₂ mm	price EUR	
NO001	1	2-5	45	6	9,280	11,600
NO002	2	5-10	48	6	11,840	14,800
NO003	3	10-15	65	8	23,200	29,000
NO004	4	15-20	86	8	46,800	58,500
NO005	5	20-25	102	10	79,200	99,000
NO006	6	25-30	115	10	139,200	174,000
NO007	7	30-35	127	12	177,600	222,000
NO008	8	35-40	136	12	236,000	295,000
NO009	9	40-50	166	12	293,000	366,250

*Posebno označene stavke (**bold**) odnose se na robu koju imamo na lageru. Za ostali asortiman rabate i rokove isporuke dajemo na osnovu upita.

*Items given in **bold** figures refer to products on stock. Discount and delivery terms for other product assortment are given at request.

*Die separat gekennzeichneten artikel (**bold**) beziehen sich auf die Ware, die auf Lager liegt. Die Rabatte und Lieferzeiten für das restliche Sortiment geben wir auf Anfrage bekannt.

UPUŠTAČI KUPASTI 60°, VALJKASTA DRŠKA

COUNTERSINKS 60°, STRAIGHT SHANK

KEGELSENKER 60°, ZYLINDERSCHAFT

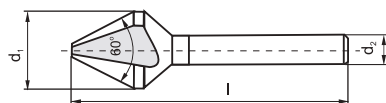

Series				SU35	SU36
	Material			HSS	Co 5%
	Type			C	C
	Number of flute			1	1
	d ₁	l	d ₂	price EUR	
	mm	mm	mm	each	each
00600	6	45	6	10,780	15,092
00800	8	50	8	11,620	16,268
01000	10	50	8	12,320	17,248
01200	12	50	8	15,680	21,952
01600	16	56	10	19,040	26,656
02000	20	60	10	28,140	39,396
02500	25	75	12	46,340	64,876
03000	30	80	12	60,760	85,064

UPUŠTAČI KUPASTI 60°, MK DRŠKA

COUNTERSINKS 60°, MORSE TAPER SHANK

KEGELSENKER 60°, MORSEKEGELSCHAFT

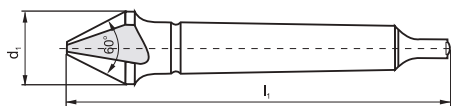

Series				SU37	SU38
	Material			HSS	Co 5%
	Type			D	D
	Number of flute			1	1
	d ₁	l ₁	MT	price EUR	
	mm	mm		each	each
01600	16	90	1	32,200	40,250
02000	20	106	2	40,600	50,750
02500	25	112	2	47,600	59,500
03150	31,5	118	2	74,200	92,750
04000	40	150	3	145,600	182,000
05000	50	160	3	236,600	295,750
06300	63	190	4	322,000	402,500
08000	80	200	4	597,800	747,250

*Posebno označene stavke (**bold**) odnose se na robu koju imamo na lageru. Za ostali asortiman rabate i rokove isporuke dajemo na osnovu upita.

*Items given in **bold** figures refer to products on stock. Discount and delivery terms for other product assortment are given at request.

*Die separat gekennzeichneten artikel (**bold**) beziehen sich auf die Ware, die auf Lager liegt. Die Rabatte und Lieferzeiten für das restliche Sortiment geben wir auf Anfrage bekannt.

UPUŠTAČI KUPASTI 90°, VALJKASTA DRŠKA

COUNTERSINKS 90°, STRAIGHT SHANK

KEGELSENKER 90°, ZYLINDERSCHAFT

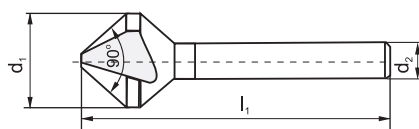

Series				SU39	SU40
Material				HSS	Co 5%
Type				C	C
Number of flute				1	1
	d ₁	l ₁	d ₂	price EUR	
	mm	mm	mm	each	each
00600	6	45	6	10,780	15,092
00800	8	50	8	11,620	16,268
01000	10	50	8	12,320	17,248
01200	12	50	8	15,680	21,952
01600	16	56	10	19,040	26,656
02000	20	60	10	28,140	39,396
02500	25	75	12	46,340	64,876
03000	30	80	12	60,760	85,064

UPUŠTAČI KUPASTI 90°, MK DRŠKA

COUNTERSINKS 90°, MORSE TAPER SHANK

KEGELSENKER 90°, MORSEKEGELSCHAFT

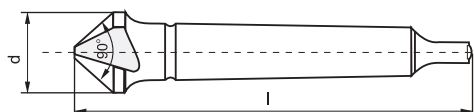

Series				SU41	SU42
Material				HSS	Co 5%
Type				D	D
Number of flute				1	1
	d	l	MT	price EUR	
	mm	mm		each	each
01600	16	90	1	32,200	40,250
02000	20	106	2	40,600	50,750
02500	25	112	2	47,600	59,500
03150	31,5	118	2	74,200	92,750
04000	40	150	3	145,600	182,000
05000	50	160	3	236,600	295,750
06300	63	190	4	322,000	402,500
08000	80	200	4	597,800	747,250

*Posebno označene stavke (**bold**) odnose se na robu koju imamo na lageru. Za ostali asortiman rabate i rokove isporuke dajemo na osnovu upita.

*Items given in **bold** figures refer to products on stock. Discount and delivery terms for other product assortment are given at request.

*Die separat gekennzeichneten artikel (**bold**) beziehen sich auf die Ware, die auf Lager liegt. Die Rabatte und Lieferzeiten für das restliche Sortiment geben wir auf Anfrage bekannt.

UPUŠTAČI KUPASTI 60°, VALJKASTA DRŠKA

COUNTERSINKS 60°, STRAIGHT SHANK

KEGELSENKER 60°, ZYLINDERSCHAFT

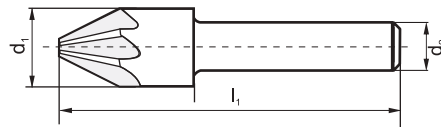

Series				SU11	SU12
Material				HSS	Co 5%
Type				A	A
Number of flute				5-7	5-7
	d ₁	l ₁	d ₂	price EUR	
	mm	mm	mm	each	each
00800	8	50	8	11,480	16,072
01250	12,5	50	8	15,512	21,714
01600	16	60	10	18,200	25,480
02000	20	63	10	26,180	36,652

UPUŠTAČI KUPASTI 60°, MK DRŠKA

COUNTERSINKS 60°, MORSE TAPER SHANK

KEGELSENKER 60°, MORSEKEGELSCHAFT

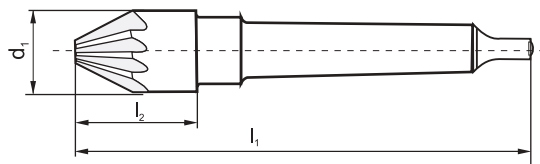

Series				SU13	SU14
Material				HSS	Co 5%
Type				B	B
Number of flute				6-18	6-18
	d ₁	l ₁	MT	price EUR	
	mm	mm		each	each
01600	16	100	1	28,000	35,000
02500	25	125	2	38,500	48,132
03150	31,5	132	2	63,000	78,750
04000	40	160	3	126,000	157,500
05000	50	170	3	204,400	255,500
06300	63	200	4	352,800	441,000
08000	80	215	4	646,800	808,500

*Posebno označene stavke (**bold**) odnose se na robu koju imamo na lageru. Za ostali asortiman rabate i rokove isporuke dajemo na osnovu upita.

*Items given in **bold** figures refer to products on stock. Discount and delivery terms for other product assortment are given at request.

*Die separat gekennzeichneten artikel (**bold**) beziehen sich auf die Ware, die auf Lager liegt. Die Rabatte und Lieferzeiten für das restliche Sortiment geben wir auf Anfrage bekannt.

UPUŠTAČI KUPASTI 60°, VALJKASTA DRŠKA

COUNTERSINKS 60°, STRAIGHT SHANK

KEGELSENKER 60°, ZYLINDERSCHAFT

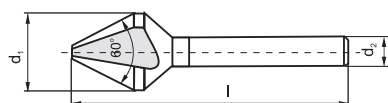

Series					SU15	SU16
Material					HSS	Co 5%
Type					C	C
Number of flute					3	3
	d ₁	l ₁	d ₂	d ₃	price EUR	
	mm	mm	mm	mm	each	each
00630	6,3	45	5	1,6	9,800	13,720
00800	8	50	6	2	11,508	16,114
01250	12,5	56	8	3,2	15,400	21,560
01600	16	63	10	4	18,200	25,480
02000	20	67	10	5	26,320	36,848
02500	25	71	10	6,3	46,900	65,660

UPUŠTAČI KUPASTI 60°, MK DRŠKA

COUNTERSINKS 60°, MORSE TAPER SHANK

KEGELSENKER 60°, MORSEKEGELSCHAFT

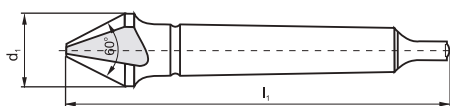

Series					SU17	SU18
Material					HSS	Co 5%
Type					D	D
Number of flute					3	3
	d ₁	l ₁	d ₂	MT	price EUR	
	mm	mm	mm		each	each
01600	16	90	4	1	25,200	31,500
02000	20	106	5	2	30,800	38,500
02500	25	112	6,3	2	35,000	43,750
03150	31,5	118	10	2	58,800	73,500
04000	40	150	12,5	3	116,200	145,250
05000	50	160	16	3	203,000	253,750
06300	63	190	20	4	336,000	420,000
08000	80	200	25	4	630,000	787,500

*Posebno označene stavke (**bold**) odnose se na robu koju imamo na lageru. Za ostali asortiman rabate i rokove isporuke dajemo na osnovu upita.

*Items given in **bold** figures refer to products on stock. Discount and delivery terms for other product assortment are given at request.

*Die separat gekennzeichneten artikel (**bold**) beziehen sich auf die Ware, die auf Lager liegt. Die Rabatte und Lieferzeiten für das restliche Sortiment geben wir auf Anfrage bekannt.

UPUŠTAČI KUPASTI 90°, VALJKASTA DRŠKA

COUNTERSINKS 90°, STRAIGHT SHANK

KEGELSENKER 90°, ZYLINDERSCHAFT

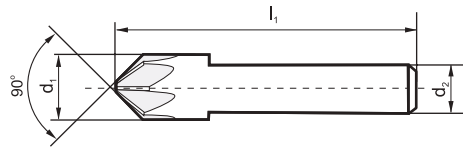

Series				SU21	SU22
Material				HSS	CO 5%
Type				A	A
Number of flute				5-7	5-7
	d ₁	l ₁	d ₂	price EUR	
	mm	mm	mm	each	each
00800	8	48	8	11,200	15,680
01250	12,5	48	8	15,064	21,084
01600	16	56	10	17,080	23,912
02000	20	60	10	24,500	34,300

UPUŠTAČI KUPASTI 90°, MK DRŠKA

COUNTERSINKS 90°, MORSE TAPER SHANK

KEGELSENKER 90°, MORSEKEGELSCHAFT

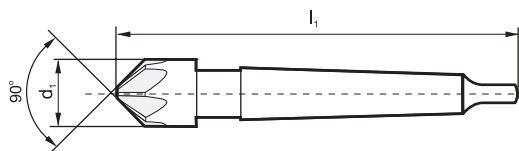

Series				SU23	SU24
Material				HSS	CO 5%
Type				B	B
Number of flute				6-18	6-18
	d ₁	l ₁	MT	price EUR	
	mm	mm		each	each
01600	16	95	1	26,600	33,250
02500	25	118	2	36,582	45,724
03150	31,5	122	2	59,850	74,816
04000	40	150	3	119,700	149,632
05000	50	155	3	194,180	242,732
06300	63	185	4	335,160	418,950
08000	80	196	4	614,460	768,082

*Posebno označene stavke (**bold**) odnose se na robu koju imamo na lageru. Za ostali asortiman rabate i rokove isporuke dajemo na osnovu upita.

*Items given in **bold** figures refer to products on stock. Discount and delivery terms for other product assortment are given at request.

*Die separat gekennzeichneten artikel (**bold**) beziehen sich auf die Ware, die auf Lager liegt. Die Rabatte und Lieferzeiten für das restliche Sortiment geben wir auf Anfrage bekannt.

UPUŠTAČI KUPASTI 90°, VALJKASTA DRŠKA

COUNTERSINKS 90°, STRAIGHT SHANK

KEGELSENKER 90°, ZYLINDERSCHAFT

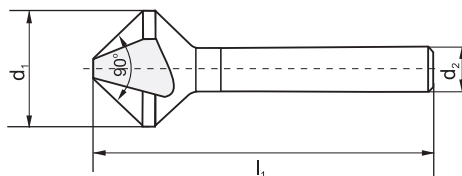

Series				SU25	SU26
	Material			HSS	CO 5%
	Type			C	C
	Number of flute			3	3
	d ₁	l ₁	d ₂	price EUR	
	mm	mm	mm	each	each
00430	4.3	40	4	8,400	11,760
00500	5	40	4	8,400	11,760
00530	5.3	40	4	8,400	11,760
00580	5.8	45	5	8,400	11,760
00600	6	45	5	8,400	11,760
00630	6.3	45	5	8,400	11,760
00700	7	50	6	9,240	12,936
00730	7.3	50	6	9,660	13,524
00800	8	50	6	9,800	13,720
00830	8.3	50	6	9,800	13,720
00940	9.4	50	6	10,920	15,288
01000	10	50	6	12,040	16,856
01040	10.4	50	6	12,320	17,248
01150	11.5	56	8	13,580	19,012
01240	12.4	56	8	13,720	19,208
01340	13.4	56	8	14,000	19,600
01500	15	60	10	14,840	20,776
01650	16.5	60	10	16,100	22,540
01900	19	63	10	21,700	30,380
02050	20.5	63	10	22,400	31,360
02300	23	67	10	33,600	47,040
02500	25	67	10	36,400	50,960
02600	26	67	10	42,000	58,800
02800	28	71	12	49,000	68,600
03000	30	71	12	50,400	70,560
03100	31	71	12	51,800	72,520

*Posebno označene stavke (**bold**) odnose se na robu koju imamo na lageru. Za ostali asortiman rabate i rokove isporuke dajemo na osnovu upita.

*Items given in **bold** figures refer to products on stock. Discount and delivery terms for other product assortment are given at request.

*Die separat gekennzeichneten artikel (**bold**) beziehen sich auf die Ware, die auf Lager liegt. Die Rabatte und Lieferzeiten für das restliche Sortiment geben wir auf Anfrage bekannt.

UPUŠTAČI KUPASTI 90°, MK DRŠKA

COUNTERSINKS 90°, MORSE TAPER SHANK

KEGELSENKER 90°, MORSEKEGELSCHAFT

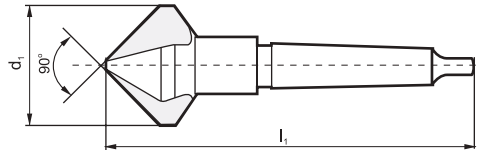

Series				SU27	SU28
	Material			HSS	CO 5%
	Type			D	D
	Number of flute			3	3
	d ₁	l ₁	MT	price EUR	
	mm	mm		each	each
01500	15	85	1	20,160	25,200
01650	16.5	85	1	23,240	29,050
01900	19	100	2	27,300	34,132
02050	20.5	100	2	28,000	35,000
02300	23	106	2	29,400	36,750
02500	25	106	2	38,780	48,482
02600	26	106	2	38,780	48,482
02800	28	112	2	47,600	59,500
03000	30	112	2	51,380	64,232
03100	31	113	2	56,000	70,000
03400	34	118	2	63,700	79,632
03700	37	118	2	71,400	89,250
04000	40	140	3	99,400	124,250
05000	50	150	3	161,000	201,250
06300	63	180	4	280,000	350,000
08000	80	190	4	520,800	651,000

*Posebno označene stavke (**bold**) odnose se na robu koju imamo na lageru. Za ostali asortiman rabate i rokove isporuke dajemo na osnovu upita.

*Items given in **bold** figures refer to products on stock. Discount and delivery terms for other product assortment are given at request.

*Die separat gekennzeichneten artikel (**bold**) beziehen sich auf die Ware, die auf Lager liegt. Die Rabatte und Lieferzeiten für das restliche Sortiment geben wir auf Anfrage bekannt.

UPUŠTAČI KUPASTI 120°, VALJKASTA DRŠKA

COUNTERSINKS 120°, STRAIGHT SHANK

KEGELSENKER 120°, ZYLINDERSCHAFT

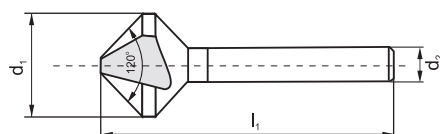

Series				SU31	SU32
Material				HSS	CO 5%
Type				C	C
Number of flute				3	3
	d ₁	l ₁	d ₂	price EUR	
	mm	mm	mm	each	each
00630	6.3	45	5	9,800	13,720
00830	8.3	50	6	11,508	16,114
01040	10.4	50	6	13,720	19,208
01240	12.4	56	8	15,400	21,560
01600	16	60	10	18,200	25,480
01650	16.5	60	10	18,480	25,872
02050	20.5	63	10	26,320	36,848
02500	25	67	10	46,900	65,660

UPUŠTAČI KUPASTI 120°, MK DRŠKA

COUNTERSINKS 120°, MORSE TAPER SHANK

KEGELSENKER 120°, MORSEKEGELSCHAFT

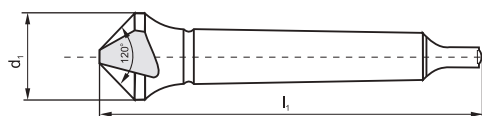

Series				SU33	SU34
Material				HSS	CO 5%
Type				D	D
Number of flute				3	3
	d ₁	l ₁	MT	price EUR	
	mm	mm		each	each
01650	16.5	86	1	28,420	35,532
02050	20.5	103	2	35,560	44,450
02500	25	112	2	38,500	48,132
03100	31	117	2	63,280	79,100
04000	40	140	3	127,400	159,250

*Posebno označene stavke (**bold**) odnose se na robu koju imamo na lageru. Za ostali asortiman rabate i rokove isporuke dajemo na osnovu upita.

*Items given in **bold** figures refer to products on stock. Discount and delivery terms for other product assortment are given at request.

*Die separat gekennzeichneten artikel (**bold**) beziehen sich auf die Ware, die auf Lager liegt. Die Rabatte und Liferzeiten für das restliche Sortiment geben wir auf Anfrage bekannt.

GLATKE BURGIJE ZA LIM

SHEET AND TUBE DRILLS

BLECHSCHÄLBOHRER

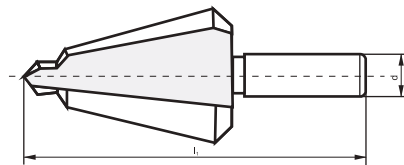

Series	Material				SU51	SU52
	N ₀	min-max mm	l ₁ mm	d mm	HSS	Co 5%
					price EUR	
					each	each
NO001	1	3-14	58	6	11,060	13,832
NO002	2	6-20	63	8	19,320	24,150
NO003	3	16-30	72	10	39,200	49,000
NO004	4	26-40	86	10	84,000	105,000
NO005	5	35-50	89	12	126,000	157,500
NO006	6	46-60	90	12	210,000	262,500
NO007	7	3-22,5	73	8	48,020	60,032
NO008	8	3-31	102	10	66,080	82,600

STEPENASTE BURGIJE ZA LIM

STEP DRILLS FOR SHEET

STUFENBOHRER FÜR BLECHE

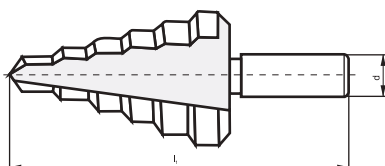

Series	Material						SU55	SU56
	N ₀	min-max mm	steps mm	steps number	l ₁ mm	d mm	price EUR	
							each	each
							each	each
N0001	1	4-12	2	5	55	6	23,800	29,750
N0002	2	4-12	1	9	70	6	25,200	31,500
N0003	3	12-20	1	9	85	10	67,200	84,000
N0004	4	4-20	2	9	85	10	35,560	44,450
N0005	5	20-30	1	11	97	13	114,800	143,500
N0006	6	4-30	2	14	96	10	77,000	96,250
N0007	7	30-40	1	11	97	13	159,600	199,500
N0008	8	40-50	1	11	100	13	226,800	283,500
N0009	9	6,3-26,75		7	90	13	99,400	124,250
N0010	10	6,3-38		11	96	13	126,000	157,500

*Posebno označene stavke (**bold**) odnose se na robu koju imamo na lageru. Za ostali asortiman rabate i rokove isporuke dajemo na osnovu upita.

*Items given in **bold** figures refer to products on stock. Discount and delivery terms for other product assortment are given at request.

*Die separat gekennzeichneten artikel (**bold**) beziehen sich auf die Ware, die auf Lager liegt. Die Rabatte und Lieferzeiten für das restliche Sortiment geben wir auf Anfrage bekannt.

SPECIJALNE BURGJE

SPECIAL DRILLS

SPEZIALBOHRER

BURGIJA ZA VAR, KRATKA

SPOTLE DRILLS

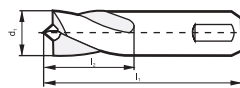

Series	Material				SU63	SU64
					HSS	Co 5%
	d ₁	d ₂	l ₁	l ₂	price EUR	
	mm	mm	mm	mm	each	each
00650	6,5	6,5	40	18	4,032	5,040
00800	8	8	40	18	4,928	6,160
00800	8	8	44	18	5,152	6,440
00658	6,5	8	44	18	5,668	7,084

BURGIJA ZA VAR

FAST CUT

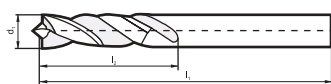

Series	Material			SU65	SU66
				HSS	Co 5%
	d ₁	l ₁	l ₂	price EUR	
	mm	mm	mm	each	each
00600	6	65	28	4,032	4,844
00700	7	75	35	4,928	5,908
00800	8	80	38	5,152	6,188
01000	10	90	45	6,300	7,560

BURGIJA - GLODALO

MILLING DRILLS

FRÄSBOHRER

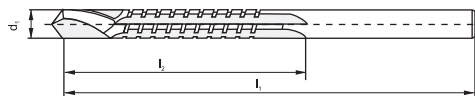

Series	Material			SU67	SU68
				HSS	Co 5%
	d ₁	l ₁	l ₂	price EUR	
	mm	mm	mm	each	each
00600	6	90	60	9,100	10,920
00800	8	90	60	10,080	12,096

*Posebno označene stavke (**bold**) odnose se na robu koju imamo na lageru. Za ostali asortiman rabate i rokove isporuke dajemo na osnovu upita.

*Items given in **bold** figures refer to products on stock. Discount and delivery terms for other product assortment are given at request.

*Die separat gekennzeichneten artikel (**bold**) beziehen sich auf die Ware, die auf Lager liegt. Die Rabatte und Liferzeiten für das restliche Sortiment geben wir auf Anfrage bekannt.

NASADNI UPUŠTAČI SA KONUSOM 1:30

SHELL DRILL WITH TAPER 1:30

AUFSTECK - AUFBOHRER MIT KEGELBOHRUNG 1:30

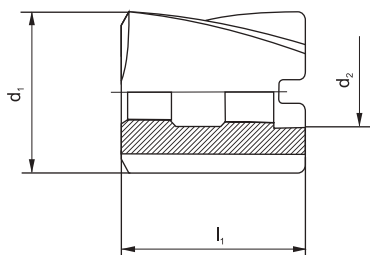

Series	Material			SU71	SU72
				HSS	Co 5%
	d ₁	l ₁	d ₂	price EUR	
	mm	mm	mm	each	each
03000	30	45	13	60,800	85,120
03100	31	45	13	68,000	95,200
03200	32	45	13	62,400	87,360
03300	33	45	13	74,400	104,160
03400	34	45	13	75,200	105,280
03500	35	45	13	62,400	87,360
03600	36	50	16	64,000	89,600
03700	37	50	16	80,000	112,000
03800	38	50	16	68,800	96,320
04000	40	50	16	69,600	97,440
04200	42	50	16	70,400	98,560
04400	44	50	16	83,200	116,480
04500	45	50	16	76,000	106,400
04600	46	56	19	98,400	137,760
04700	47	56	19	108,000	151,200
04800	48	56	19	104,000	145,600
05000	50	56	19	88,800	124,320
05200	52	56	19	93,600	131,040
05500	55	63	22	110,400	154,560
05800	58	63	22	119,200	166,880
06000	60	63	22	120,000	168,000
06200	62	63	22	134,400	188,160
06500	65	71	27	164,000	229,600
07000	70	71	27	164,000	229,600
07200	72	71	27	192,800	269,920
07500	75	71	27	193,600	271,040

*Posebno označene stavke (**bold**) odnose se na robu koju imamo na lageru. Za ostali asortiman rabate i rokove isporuke dajemo na osnovu upita.

*Items given in **bold** figures refer to products on stock. Discount and delivery terms for other product assortment are given at request.

*Die separat gekennzeichneten artikel (**bold**) beziehen sich auf die Ware, die auf Lager liegt. Die Rabatte und Lieferzeiten für das restliche Sortiment geben wir auf Anfrage bekannt.

REDUCIR ČAURE, POTPUNO KALJENE, BRUŠENE

TAPER SLEEVES, HARDENED AND GROUND

REDUZIERSHÜLSEN GANZ GEHARTETUND GESCHLIFFEN

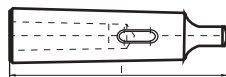

Series	Finish			SP01
	MT	MT	l	ground
	External	Internal	mm	price EUR
01000	1	0	85	19,200
02001	2	1	92	19,200
03001	3	1	99	22,400
03002	3	2	112	23,360
04001	4	1	124	31,200
04002	4	2	124	28,480
04003	4	3	140	28,000
05002	5	2	156	43,520
05003	5	3	156	47,200
05004	5	4	171	47,200
06003	6	3	218	92,800
06004	6	4	218	93,760
06005	6	5	218	95,200

DIN 2187

REDUCIR ČAURE, PRODUŽENE, POTPUNO KALJENE, BRUŠENE

EXTENSION TAPER SLEEVES HARDENED AND GROUND

VERLANGERUNGSHÜLSEN GANZ GEHÄRTETUND GESCHLIFFEN



Series	Finish			SP02
	MT	MT	l	ground
	External	Internal	mm	price EUR
01001	1	1	145	28,480
01002	1	2	160	30,240
02001	2	1	160	22,880
02002	2	2	170	29,600
02003	2	3	200	38,080
03002	3	2	195	29,600
03003	3	3	215	42,240
03004	3	4	240	65,120
04002	4	2	215	42,240
04003	4	3	240	49,280
04004	4	4	265	65,120
04005	4	5	300	128,000
05002	5	2	250	144,000
05003	5	3	268	63,360
05004	5	4	300	68,640
05005	5	5	335	130,560
05006	5	6	396	228,800
06003	6	3	330	130,240
06004	6	4	355	130,240
06005	6	5	390	131,200
06006	6	6	451	228,800

IZBIJAČ ALATA

EJECTOR DRIFTS

AUSTREIBER FÜR WERKZEUGKEGEL

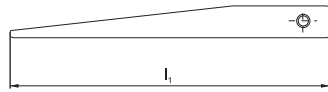

Series	Finish		SP08
	Size	l ₁ mm	ground price EUR each
00000	0	90	4,160
00102	1 - 2	140	7,520
00003	3	190	11,680
00004	4	225	17,600
00506	5 - 6	265	23,200

DIN 238

TRNOVI ZA STEZNE GLAVE

TAPER DRILL CHUCK ARBORS

KEGELDORNE FÜR BOHRFUTER

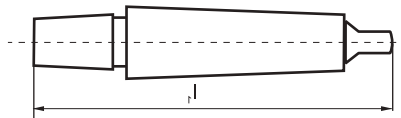

Series	Finish			SP05
	MT	Drill Chuck Taper	l ₁ mm	ground price EUR each
01010	1	B 10	86	8,160
01012	1	B 12	89	8,160
01016	1	B 16	99	9,120
01018	1	B 18	107	10,400
02010	2	B 10	105	10,720
02012	2	B 12	106	10,720
02016	2	B 16	112	10,720
02018	2	B 18	119	12,000
02022	2	B 22	130	14,080
03012	3	B 12	127	16,160
03016	3	B 16	134	16,160
03018	3	B 18	140	16,160
03022	3	B 22	147	16,160
03024	3	B 24	157	17,600
04016	4	B 16	158	24,480
04018	4	B 18	166	24,960
04022	4	B 22	176	25,760
04024	4	B 24	186	26,240
05016	5	B 16	193	43,680
05018	5	B 18	200	45,280
05022	5	B 22	208	47,360
05024	5	B 24	221	49,600

*Posebno označene stavke (**bold**) odnose se na robu koju imamo na lageru. Za ostali asortiman rabate i rokove isporuke dajemo na osnovu upita.

*Items given in **bold** figures refer to products on stock. Discount and delivery terms for other product assortment are given at request.

*Die separat gekennzeichneten artikel (**bold**) beziehen sich auf die Ware, die auf Lager liegt. Die Rabatte und Lieferzeiten für das restliche Sortiment geben wir auf Anfrage bekannt.

NOŽEVI PRAVOUGLI (D)

RECTANGULAR TOOL BITS

RECHTECKIGE DREHLINGE



Series	SN21		SN22		SN23		SN24		SN25		SN26	
	Material	Co 8-10%	Co 8-10%	Co 8-10%	Co 8-10%	Co 8-10%	Co 8-10%	Co 8-10%	Co 8-10%	Co 8-10%	Co 8-10%	
	Lenght	80	100	125	160	200	250	price EUR				
Size (h14/h14)	price EUR											
	each	each	each	each	each	each	each	each	each	each	each	
06004	6x4	4,960	6,720									
08004	8x4	5,440	6,880		11,200							
08005	8x5	6,720	8,320									
10005	10x5	8,640	11,680		18,080	21,760						
10006	10x6		12,800	13,760	21,760	26,880						
12006	12x6		14,880		23,200	27,520						
12008	12x8		16,640	24,960	27,680	33,952						
16004	16x4	11,680	14,560		23,520							
16008	16x8		21,600		32,640	39,680						
16010	16x10		25,600	33,600	43,680	53,280						
20005	20x5		20,000		32,000	39,840						
20010	20x10		29,920		48,000	59,680	75,200					
20012	20x12		30,720	40,000	52,960	65,920						
25006	25x6		24,640		37,760	45,760						
25012	25x12				69,120	86,400	107,840					
25016	25x16		47,200	62,080	82,720	103,840	129,920					
32008	32x8		42,240		63,840	77,120						
32016	32x16				123,680	154,720						
40010	40x10				97,760	122,080						

NOŽEVI TRAPEZNI (E)

TRAPEZOIDAL TOOL BITS

TRAPEZFÖRMIGE DREHLINGE



Series	SN31		SN32		SN33		SN34		SN35		SN36	
	Material	Co 8-10%	Co 8-10%	Co 8-10%	Co 8-10%	Co 8-10%	Co 8-10%	Co 8-10%	Co 8-10%	Co 8-10%	Co 8-10%	
	Lenght	80	100	125	160	200	250	price EUR				
Size (h12/h12)	price EUR											
	each	each	each	each	each	each	each	each	each	each	each	
12003	12x3	7,680	9,920	13,280	15,680	23,200						
16004	16x4	15,840	19,200	20,160	31,680	39,360						
20005	20x5	19,680	24,640	30,240	39,840	55,040						
25006	25x6		29,920	38,720	48,480	60,800	76,000					

*Posebno označene stavke (**bold**) odnose se na robu koju imamo na lageru. Za ostali asortiman rabate i rokove isporuke dajemo na osnovu upita.

*Items given in **bold** figures refer to products on stock. Discount and delivery terms for other product assortment are given at request.

*Die separat gekennzeichneten artikel (**bold**) beziehen sich auf die Ware, die auf Lager liegt. Die Rabatte und Lieferzeiten für das restliche Sortiment geben wir auf Anfrage bekannt.

NOŽEVI OKRUGLI (A)

REOUND TOOL BITS

RUNDE DREHLINGE



Series	SN01 SN02 SN03 SN04 SN05 SN06 SN07							
	Material	Co 8-10%	Co 8-10%	Co 8-10%	Co 8-10%	Co 8-10%	Co 8-10%	Co 8-10%
	Lenght	40	63	80	100	125	160	200
Size (h14)	price EUR							
	each	each	each	each	each	each	each	each
00400	4	2,400	3,520	4,320				
00500	5	2,720	3,520	4,320				
00600	6	2,880	3,840	4,960	6,400	7,680	9,280	11,200
00800	8	3,520	5,280	7,040	8,800	13,280	14,080	16,000
01000	10	4,960	8,480	9,760	13,440	16,960	25,120	31,040
01200	12		9,760	12,800	14,080	21,600	32,320	40,160
01400	14					28,320	38,880	56,000
01600	16				24,640	28,320	38,880	56,000
01800	18						75,040	108,000
02000	20				36,960	52,320	87,200	108,800

NOŽEVI KVADRATNI (B)

SQUARE TOOL BITS

QUADRATISCHE DREHLINGE





















Series	SN11 SN12 SN13 SN14 SN15 SN16 SN17 SN18								
	Material	Co 8-10%	Co 8-10%	Co 8-10%	Co 8-10%	Co 8-10%	Co 8-10%	Co 8-10%	Co 8-10%
	Lenght	40	63	80	100	125	160	200	250
Size (h14)	price EUR								
	each	each	each	each	each	each	each	each	each
00400	4x4	2,720	3,360	4,640					
00500	5x5	3,200	5,280	6,400					
00600	6x6	2,880	4,640	5,920	7,360	9,120	11,840	14,720	
00800	8x8	5,440	6,400	8,160	10,240	15,200	16,320	20,800	
01000	10x10		10,240	12,800	17,280	21,760	28,320	36,320	
01200	12x12		13,760	18,240	21,760	28,320	36,800	47,200	
01400	14x14				26,720	32,480	43,680	52,640	
01600	16x16				34,720	54,240	59,360	77,120	
01800	18x18						72,480	90,880	
02000	20x20						92,160	117,120	144,000
02500	25x25						147,040	183,520	228,480

*Posebno označene stavke (**bold**) odnose se na robu koju imamo na lageru. Za ostali asortiman rabate i rokove isporuke dajemo na osnovu upita.

*Items given in **bold** figures refer to products on stock. Discount and delivery terms for other product assortment are given at request.

*Die separat gekennzeichneten artikel (**bold**) beziehen sich auf die Ware, die auf Lager liegt. Die Rabatte und Lieferzeiten für das restliche Sortiment geben wir auf Anfrage bekannt.

SADRŽAJ - CONTENTS - INHALTSVERZEICHNIS

DIN	SERIES		PAGE
4971 - 4981	TN01-TN14		2T
8039	TB10		5T
	TB02-TB05		
	TB21		6T
	TB15-TB23		7T
338	TB14		8T
345	TB11		9T
8037	TB12		10T
8041	TB13		11T
8026	TG01		12T
8027	TG02		
8044	TG03		13T
8045	TG04		
8050	TR01-TR02		14T
8093	TR05-TR06		15T
8051	TR11-TR12		16T
8094	TR15-TR16		17T
8054	TR21		18T

SADRŽAJ - CONTENTS - INHALTSVERZEICHNIS

<i>DIN</i>	<i>SERIES</i>		<i>PAGE</i>
	TG51		19T
	TG61 - TG64		21T

STANDARDNI STRUGARSKI NOŽEVI SA TM

CARBIDE TIPPED TURNING TOOL BITS

HARTMETALL - DREHMEISSEL

DIN 4971 ISO 1

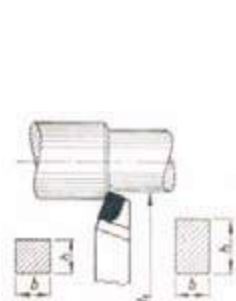

Series	TN01			
	h	b	l	price EUR
	mm	mm	mm	each
01010	10	10	90	4,968
01212	12	12	100	5,400
01616	16	16	110	7,410
02020	20	20	125	11,952
02525	25	25	140	19,123
03232	32	32	170	33,465
02012	20	12	125	8,605
02516	25	16	140	12,908
03220	32	20	170	21,513

DIN 4972 ISO 2

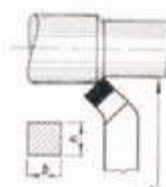

Series	TN02			
	h	b	l	price EUR
	mm	mm	mm	each
01010	10	10	90	5,400
01212	12	12	100	5,832
01616	16	16	110	7,888
02020	20	20	125	11,952
02525	25	25	140	21,513
03232	32	32	170	38,246

DIN 4978 ISO 3

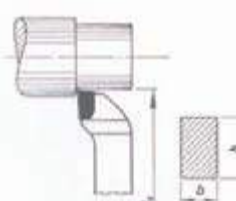

Series	TN03			
	h	b	l	price EUR
	mm	mm	mm	each
01010	10	10	90	4,752
01212	12	12	100	5,184
01616	16	16	110	8,605
02020	20	20	125	10,663
02525	25	25	140	16,732
03232	32	32	170	28,684
01610	16	10	110	6,215
02012	20	12	125	6,693
02516	25	16	140	10,517
03220	32	20	170	16,732

DIN 4976 ISO 4

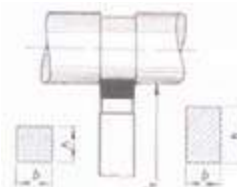

Series	TN04			
	h	b	l	price EUR
	mm	mm	mm	each
01010	10	10	90	5,400
01212	12	12	100	6,828
01616	16	16	110	10,610
02020	20	20	125	16,732
02525	25	25	140	26,301
03232	32	32	170	50,198
02012	20	12	125	9,561
02516	25	16	140	13,386
03220	32	20	170	21,513

*Posebno označene stavke (**bold**) odnose se na robu koju imamo na lageru. Za ostali asortiman rabate i rokove isporuke dajemo na osnovu upita.

*Items given in **bold** figures refer to products on stock. Discount and delivery terms for other product assortment are given at request.

*Die separat gekennzeichneten artikel (**bold**) beziehen sich auf die Ware, die auf Lager liegt. Die Rabatte und Lieferzeiten für das restliche Sortiment geben wir auf Anfrage bekannt.

DIN 4977 ISO 5

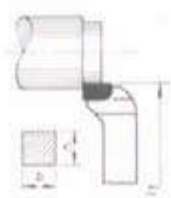

Series	TN05			
	h	b	l	price EUR
	mm	mm	mm	each
01010	10	10	90	8,640
01212	12	12	100	8,856
01616	16	16	110	10,039
02020	20	20	125	12,337
02525	25	25	140	21,513
03232	32	32	170	39,680

DIN 4980 ISO 6

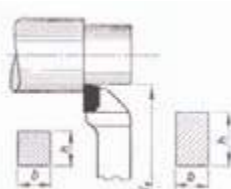

Series	TN06			
	h	b	l	price EUR
	mm	mm	mm	each
01010	10	10	90	5,400
01212	12	12	100	6,048
01616	16	16	110	7,888
02020	20	20	125	11,952
02525	25	25	140	23,904
03232	32	32	170	38,246
02012	20	12	125	7,410
02516	25	16	140	11,952
03220	32	20	170	21,513

DIN 4981 ISO 7

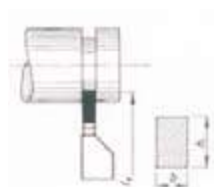

Series	TN07			
	h	b	l	price EUR
	mm	mm	mm	each
01010	10	10	90	6,264
01212	12	12	100	7,128
01616	16	16	110	8,512
02020	20	20	125	11,712
02525	25	25	140	21,513
03232	32	32	170	35,856
01208	12	8	100	5,199
01610	16	10	110	7,410
02012	20	12	125	8,366
02516	25	16	140	10,517
03220	32	20	170	19,123

DIN 4975



Series	TN10			
	h	b	l	price EUR
	mm	mm	mm	each
01212	12	12	100	5,184
01616	16	16	110	5,976
02020	20	20	125	7,649
02525	25	25	140	11,473
03232	32	32	170	21,513
01208	12	8	100	4,302
01610	16	10	110	5,736
02012	20	12	125	5,976
02516	25	16	140	8,127
03220	32	20	170	14,342

*Posebno označene stavke (**bold**) odnose se na robu koju imamo na lageru. Za ostali asortiman rabate i rokove isporuke dajemo na osnovu upita.

*Items given in **bold** figures refer to products on stock. Discount and delivery terms for other product assortment are given at request.

*Die separat gekennzeichneten artikel (**bold**) beziehen sich auf die Ware, die auf Lager liegt. Die Rabatte und Lieferzeiten für das restliche Sortiment geben wir auf Anfrage bekannt.

DIN 282

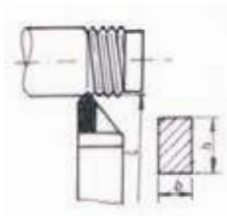

Series	TN13			price EUR
	h	b	l	
	mm	mm	mm	each
01010	10	10	90	6,480
01212	12	12	100	6,912
01616	16	16	100	8,127
02020	20	20	110	10,663
02525	25	25	125	19,123
03232	32	32	140	28,684
01208	12	8	90	5,557
01610	16	10	90	7,888
02012	20	12	100	8,366
02516	25	16	110	10,517
03220	32	20	125	21,513

DIN 4973 ISO 8

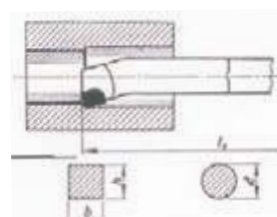

Series	TN08					price EUR
	h	b	d	l	l ₁	
	mm	mm	mm	mm	mm	each
00808	8	8	8	125	40	5,616
01010	10	10	10	150	50	5,832
01212	12	12	12	180	63	7,344
01616	16	16	16	210	80	9,083
02020	20	20	20	250	100	11,620
02525	25	25	25	300	125	18,167
03232	32	32	32	355	150	35,856

DIN 4974 ISO 9

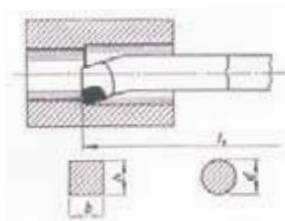

Series	TN09					price EUR
	h	b	d	l	l ₁	
	mm	mm	mm	mm	mm	each
00808	8	8	8	125	40	5,964
01010	10	10	10	150	50	6,132
01212	12	12	12	180	63	6,396
01616	16	16	16	210	80	8,273
02020	20	20	20	250	100	11,952
02525	25	25	25	300	125	19,123
03232	32	32	32	355	150	37,290

DIN 283

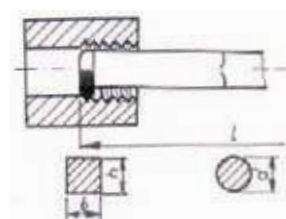

Series	TN14					price EUR
	h	b	d	l	l ₁	
	mm	mm	mm	mm	mm	each
01010	10	10		150	40	9,936
01212	12	12	12	180	50	11,232
01616	16	16	16	210	65	15,298
02020	20	20	20	250	85	19,123
02525	25	25	25	300	105	27,723
03232	32	32	32	355	135	44,461

*Posebno označene stavke (**bold**) odnose se na robu koju imamo na lageru. Za ostali asortiman rabate i rokove isporuke dajemo na osnovu upita.

*Items given in **bold** figures refer to products on stock. Discount and delivery terms for other product assortment are given at request.

*Die separat gekennzeichneten artikel (**bold**) beziehen sich auf die Ware, die auf Lager liegt. Die Rabatte und Lieferzeiten für das restliche Sortiment geben wir auf Anfrage bekannt.

**BURGIJE ZA KAMEN SA TM,
VALJKASTA DRŠKA**

**CARBIDE TIPPED MASONRY DRILLS,
STRAIGHT SHANK**

**HARTMETALL - STEINBOHRER,
ZYLINDERSCHAFT**



Series	Execution				TB01
	Finish				rolled
	d ₁	d ₂	l ₁	l ₂	bright (zinc)
	mm	mm	mm	mm	price EUR
00300	3	2.6	65	32	1,092
00400	4	3.2	70	40	0,896
00500	5	3.8	80	50	0,938
00600	6	4.7	100	60	0,994
00650	6,5	5.4	100	60	1,093
00700	7	5.4	110	60	1,120
00800	8	6.4	125	80	1,274
00900	9	7.2	125	80	1,526
01000	10	7.8	125	80	1,652
01100	11	8.5	140	90	1,932
01200	12	8.5	140	90	2,576

BURGIJE ZA KAMEN SA TM, DUGE, VALJKASTA DRŠKA

CARBIDE TIPPED MASONRY DRILLS, LONG SERIES, STRAIGHT SHANK

HARTMETALL - STEINBOHRER, LANGE, ZYLINDERSCHAFT



Series	Execution		TB02	TB03	TB04	TB05
	Finish		rolled	rolled	rolled	rolled
	l ₁	l ₂	bright	bright	bright	bright
	mm	mm	price EUR	price EUR	price EUR	price EUR
00600	6	4,7	1,512	2,436	3,052	
00800	8	6,4	1,904	2,590	3,080	
01000	10	7,8	2,464	3,388	4,256	6,258
01200	12	8.5	4,466	4,886	5,110	6,832

*Posebno označene stavke (**bold**) odnose se na robu koju imamo na lageru. Za ostali asortiman rabate i rokove isporuke dajemo na osnovu upita.

*Items given in **bold** figures refer to products on stock. Discount and delivery terms for other product assortment are given at request.

*Die separat gekennzeichneten artikel (**bold**) beziehen sich auf die Ware, die auf Lager liegt. Die Rabatte und Lieferzeiten für das restliche Sortiment geben wir auf Anfrage bekannt.

**BURGIJE ZA BETON SA TM, PROFESIONAL,
VALJKASTA DRŠKA**

**CARBIDE TIPPED MASONRY DRILLS,
PROFESSIONAL QUALITY, STRAIGHT SHANK**

**HARTMETALL SUPER - SCHLAG BETONBOHRER,
ZYLINDERSCHAFT**



Series	Execution				TB21	TB24
	Finish				ground	ground
	d ₁	d ₂	l ₁	l ₂	bright	bright
	price EUR					
	mm	mm	mm	mm	each	each
00300	3	2.6	60	40	1,820	2,002
00400	4	3.6	75	40	1,820	2,002
00450	4.5	4	85	50	2,016	2,218
00500	5	4.5	85	50	1,876	2,064
00550	5.5	5	85	50	2,072	2,279
00600	6	5.2	100	60	2,016	2,218
00650	6.5	6	100	85	2,212	2,433
00700	7	6.2	100	85	2,268	2,495
00800	8	7.3	120	80	2,548	2,803
00900	9	8.3	120	80	3,024	3,326
01000	10	9.2	120	80	3,304	3,634
01100	11	10	150	90	4,284	4,712
01200	12	10	150	90	4,284	4,712
01300	13	10	150	90	5,880	6,468
01400	14	10	150	90	7,280	8,008
01500	15	10	150	90	8,680	9,548
01600	16	10	150	90	8,680	9,548
01800	18	13	160	100	10,920	12,012
01900	19	13	160	100	12,012	13,213
02000	20	13	160	100	12,740	14,014
02200	22	13	160	100	15,400	16,940
02400	24	13	160	100	22,960	25,256
02500	25	13	160	100	23,520	25,872

*Posebno označene stavke (**bold**) odnose se na robu koju imamo na lageru. Za ostali asortiman rabate i rokove isporuke dajemo na osnovu upita.

*Items given in **bold** figures refer to products on stock. Discount and delivery terms for other product assortment are given at request.

*Die separat gekennzeichneten artikel (**bold**) beziehen sich auf die Ware, die auf Lager liegt. Die Rabatte und Lieferzeiten für das restliche Sortiment geben wir auf Anfrage bekannt.

**BURGIJE ZA BETON SA TM, PROFESIONAL,
 DUGE, VALJKASTA DRŠKA**

**CARBIDE TIPPED MASONRY DRILLS, PROFESSIONAL QUALITY,
 LONG SERIES, STRAIGHT SHANK**

**HARTMETALL SUPER - SCHLAG BETONBOHRER,
 LANGE, ZYLINDERSCHAFT**



Series	Execution		TB15	TB16	TB17	TB22	TB23	
	Finish		milled	milled	milled	milled	milled	
			bright	bright	bright	bright	bright	
	l_1	mm	150	200	300	400	600	
	l_2	mm	85	135	180	230	400	
	d_1	d_2	price EUR					
	mm	mm	each	each	each	each	each	
00500	5	4.5	2,492	2,828	4,480			
00600	6	5.2	2,842	3,178	5,040	6,762	10,626	
00700	7	6.2	3,164	4,004	5,544	7,014	13,244	
00800	8	7.3	3,542	4,004	5,544	7,014	13,244	
00900	9	8.3	4,214	5,544	6,930	9,240	13,860	
01000	10	9.2	4,606	5,544	6,930	9,240	13,860	
01200	12	10		6,776	8,932	11,606	17,430	
01300	13	10		8,876	10,346	13,860	20,790	
01400	14	10		8,876	10,598	13,860	20,790	
01500	15	10		9,856	12,320	16,632	24,948	
01600	16	10		9,856	12,320	16,632	24,948	
01800	18	13		12,628	15,764	21,252	31,878	
02000	20	13			18,480	24,948	37,422	
02200	22	13			21,560	28,896	43,330	
02400	24	13			25,004	33,320	53,648	
02500	25	13			26,796	35,756	57,568	

*Posebno označene stavke (**bold**) odnose se na robu koju imamo na lageru. Za ostali asortiman rabate i rokove isporuke dajemo na osnovu upita.

*Items given in **bold** figures refer to products on stock. Discount and delivery terms for other product assortment are given at request.

*Die separat gekennzeichneten artikel (**bold**) beziehen sich auf die Ware, die auf Lager liegt. Die Rabatte und Lieferzeiten für das restliche Sortiment geben wir auf Anfrage bekannt.

**SPIRALNA BURGIJA ZA METAL SA TM,
 VALJKASTA DRŠKA**

**CARBIDE TIPPED TWIST DRILLS FOR DRILLING METAL,
 STRAIGHT SHANK**

**HARTMETAL - SPIRALBOHRER FÜR METAL,
 ZYLINDERSCHAFT**



Series	d	l ₁	l ₂	TB14 price EUR
	mm	mm	mm	each
00400	4	75	43	12,228
00450	4,5	80	47	12,408
00500	5	86	52	12,408
00550	5,5	93	57	13,152
00600	6	93	57	13,152
00650	6,5	101	63	14,076
00700	7	109	69	14,076
00750	7,5	109	69	15,396
00800	8	117	75	15,396
00850	8,5	117	75	16,500
00900	9	125	81	16,500
00950	9,5	125	81	17,820
01000	10	133	87	21,780

*Posebno označene stavke (**bold**) odnose se na robu koju imamo na lageru. Za ostali asortiman rabate i rokove isporuke dajemo na osnovu upita.

*Items given in **bold** figures refer to products on stock. Discount and delivery terms for other product assortment are given at request.

*Die separat gekennzeichneten artikel (**bold**) beziehen sich auf die Ware, die auf Lager liegt. Die Rabatte und Lieferzeiten für das restliche Sortiment geben wir auf Anfrage bekannt.

**SPIRALNA BURGIJA ZA METAL SA TM,
 MK DRŠKA**

**CARBIDE TIPPED TWIST DRILLS FOR DRILLING METAL,
 MORSE TAPER SHANK**

**HARTMETAL - SPIRALBOHRER FÜR METAL,
 MORSEKEGELSCHAFT**

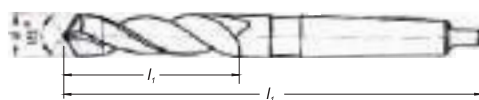

Series	TB11				
	d	l ₁	l ₂	MT	price EUR
	mm	mm	mm		each
01000	10	168	87	1	52,360
01050	10,5	168	87	1	52,360
01100	11	175	94	1	52,360
01150	11,5	175	94	1	54,670
01200	12	182	101	1	54,670
01250	12,5	182	101	1	58,520
01300	13	182	101	1	58,520
01350	13,5	189	108	1	67,760
01400	14	189	108	2	67,760
01500	15	212	114	2	69,300
01600	16	218	120	2	72,380
01700	17	223	125	2	79,310
01800	18	228	130	2	79,310
01900	19	233	135	2	83,930
02000	20	238	140	3	107,800
02100	21	243	145	3	115,500
02200	22	248	150	3	118,580
02300	23	253	155	3	121,660
02400	24	281	160	3	126,280
02500	25	281	160	3	133,210
02600	26	286	165	4	166,320
02700	27	291	170	4	172,480
02800	28	291	170	4	181,720
02900	29	296	175	4	202,510
03000	30	296	175	4	217,910

*Posebno označene stavke (**bold**) odnose se na robu koju imamo na lageru. Za ostali asortiman rabate i rokove isporuke dajemo na osnovu upita.

*Items given in **bold** figures refer to products on stock. Discount and delivery terms for other product assortment are given at request.

*Die separat gekennzeichneten artikel (**bold**) beziehen sich auf die Ware, die auf Lager liegt. Die Rabatte und Lieferzeiten für das restliche Sortiment geben wir auf Anfrage bekannt.

**SPIRALNA BURGIJA ZA METAL SA TM,
VALJKASTA DRŠKA**

**CARBIDE TIPPED TWIST DRILLS FOR DRILLING METAL,
STRAIGHT SHANK**

**HARTMETAL - SPIRALBOHRER FÜR METAL,
ZYLINDERSCHAFT**



Series	TB12			
	d ₁	l ₁	l ₂	price EUR
	mm	mm	mm	each
00400	4	56	25	7,992
00450	4,5	63	28	8,122
00500	5	63	28	8,122
00550	5,5	71	32	8,597
00600	6	71	32	8,597
00650	6,5	71	32	9,202
00700	7	80	40	9,202
00750	7,5	80	40	10,066
00800	8	80	40	10,066
00850	8,5	90	50	10,800
00900	9	90	50	10,800
00950	9,5	90	50	11,664
01000	10	100	56	14,256
01050	10,5	100	56	16,243
01100	11	100	56	16,243
01150	11,5	112	63	19,008
01200	12	112	63	19,008
01300	13	112	63	21,751
01400	14	125	71	24,797
01500	15	125	71	31,666
01600	16	140	80	37,174

*Posebno označene stavke (**bold**) odnose se na robu koju imamo na lageru. Za ostali asortiman rabate i rokove isporuke dajemo na osnovu upita.

*Items given in **bold** figures refer to products on stock. Discount and delivery terms for other product assortment are given at request.

*Die separat gekennzeichneten artikel (**bold**) beziehen sich auf die Ware, die auf Lager liegt. Die Rabatte und Lieferzeiten für das restliche Sortiment geben wir auf Anfrage bekannt.

**SPIRALNA BURGIJA ZA METAL SA TM,
MK DRŠKA**

**CARBIDE TIPPED TWIST DRILLS FOR DRILLING METAL,
MORSE TAPER SHANK**

**HARTMETAL - SPIRALBOHRER FÜR METAL,
MORSEKEGELSCHAFT**

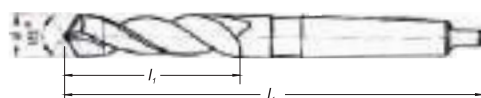

Series					TB13	
	d	l ₁	l ₂	MT	price EUR	
	mm	mm	mm		each	
01000	10	140	50	1	38,080	
01050	10,5	140	50	1	38,080	
01100	11	140	50	1	38,080	
01150	11,5	146	56	1	39,760	
01200	12	146	56	1	39,760	
01250	12,5	148	56	1	42,560	
01300	13	146	56	1	42,560	
01350	13,5	168	63	1	49,280	
01400	14	168	63	2	49,280	
01500	15	168	63	2	50,400	
01600	16	175	70	2	52,640	
01700	17	175	70	2	57,680	
01800	18	185	70	2	57,680	
01900	19	185	80	2	61,040	
02000	20	215	90	3	78,400	
02100	21	215	90	3	84,000	
02200	22	215	90	3	86,240	
02300	23	225	100	3	88,480	
02400	24	225	100	3	91,924	
02500	25	225	100	3	96,880	
02600	26	260	110	4	120,960	
02700	27	260	110	4	125,524	
02800	28	260	110	4	132,160	
02900	29	275	125	4	147,280	
03000	30	275	125	4	158,480	

*Posebno označene stavke (**bold**) odnose se na robu koju imamo na lageru. Za ostali asortiman rabate i rokove isporuke dajemo na osnovu upita.

*Items given in **bold** figures refer to products on stock. Discount and delivery terms for other product assortment are given at request.

*Die separat gekennzeichneten artikel (**bold**) beziehen sich auf die Ware, die auf Lager liegt. Die Rabatte und Lieferzeiten für das restliche Sortiment geben wir auf Anfrage bekannt.

GLODALA ZA ŽLIJEB SA TM, MK DRŠKA

CARBIDE TIPPED TWO LIPPED END MILLING CUTTERS, MORSE TAPER SHANK

HARTMETAL LANGLOCHFRÄSER, MORSEKEGELSCHAFT

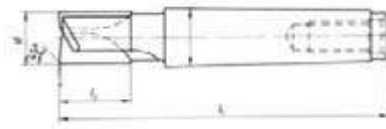

Series					TG01
	d	l ₁	l ₂	MT	price EUR
	mm	mm	mm		each
01200	12	82	16	1	49,920
01400	14	94	19	2	50,560
01600	16	101	22	2	53,120
01800	18	101	22	2	54,720
02000	20	122	22	3	55,040
02200	22	126	25	3	58,560
02400	24	131	25	3	59,200
02500	25	131	25	3	59,200

DIN 8027

GLODALA ZA ŽLIJEB SA TM, VALJKASTA DRŠKA

CARBIDE TIPPED TWO LIPPED END MILLING CUTTERS, STRAIGHT SHANK

HARTMETAL LANGLOCHFRÄSER, ZYLINDERSCHAFT

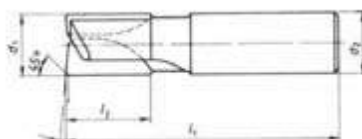

Series					TG02
	d ₁	d ₂	l ₁	l ₂	price EUR
	mm	mm	mm	mm	each
01000	10	10	60	12	29,120
01200	12	12	70	16	30,400
01400	14	12	70	19	32,320
01600	16	16	80	22	36,800
01800	18	16	80	22	38,400
02000	20	20	86	22	40,320
02200	22	20	90	25	45,040
02400	24	25	101	25	45,600
02600	26	25	101	25	47,600
02800	28	25	101	25	51,200

*Posebno označene stavke (**bold**) odnose se na robu koju imamo na lageru. Za ostali asortiman rabate i rokove isporuke dajemo na osnovu upita.

*Items given in **bold** figures refer to products on stock. Discount and delivery terms for other product assortment are given at request.

*Die separat gekennzeichneten artikel (**bold**) beziehen sich auf die Ware, die auf Lager liegt. Die Rabatte und Lieferzeiten für das restliche Sortiment geben wir auf Anfrage bekannt.

VRETENASTA GLODALA SA TM,
VALJKASTA DRŠKA

CARBIDE TIPPED END MILLING CUTTERS,
STRAIGHT SHANK

HARTMETAL - SCHAFTFRÄSER,
MORSEKEGELSCHAFT

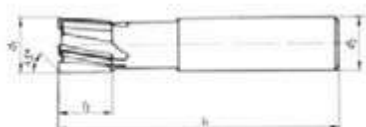

Series						TG03	
	d ₁	d ₂	l ₁	l ₂	Z	price EUR	
	mm	mm	mm	mm		each	
01000	10	10	68	12	3	32,320	
01200	12	12	77	16	3	33,920	
01600	16	16	84	16	3	35,520	
02000	20	20	90	19	4	40,000	

DIN 8045

VRETENASTA GLODALA SA TM, MK DRŠKA

CARBIDE TIPPED END MILLING CUTTERS,
MORSE TAPER SHANK

HARTMETAL - SCHAFTFRÄSER,
MORSEKEGELSCHAFT

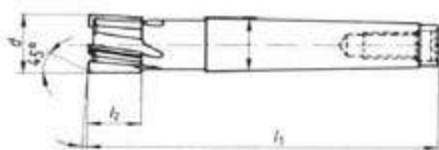

Series						TG04	
	d	l ₁	l ₂	MT	Z	price EUR	
	mm	mm	mm			each	
01200	12	89	16	1	3	38,080	
01600	16	105	16	2	3	39,040	
02000	20	126	19	3	4	41,600	
02500	25	131	19	3	4	42,560	
03200	32	170	22	4	6	54,400	
04000	40	173	25	4	6	61,760	

*Posebno označene stavke (**bold**) odnose se na robu koju imamo na lageru. Za ostali asortiman rabate i rokove isporuke dajemo na osnovu upita.

*Items given in **bold** figures refer to products on stock. Discount and delivery terms for other product assortment are given at request.

*Die separat gekennzeichneten artikel (**bold**) beziehen sich auf die Ware, die auf Lager liegt. Die Rabatte und Lieferzeiten für das restliche Sortiment geben wir auf Anfrage bekannt.

MAŠINSKI RAZVRTAČ SA TM, KRATKI,
 VALJKASTA DRŠKA

CARBIDE TIPPED CHUCKING REAMERS,
 STRAIGHT SHANK

HARTMETAL - MASCHINEREIBAHLEN,
 ZYLINDERSCHAFT

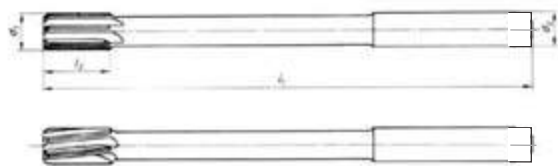

Series	Type				TR01	TR02
	d ₁	d ₂	l ₁	l ₂	A	B
					price EUR	
	mm	mm	mm	mm	each	each
00800	8	8	117	16	20,400	20,400
00900	9	9	125	19	24,000	24,000
01000	10	10	133	19	24,000	24,000
01100	11	10	142	19	28,800	28,800
01200	12	10	151	19	30,000	30,000
01300	13	10	151	19	33,600	33,600
01400	14	12,5	160	19	36,000	36,000
01500	15	12,5	162	19	38,400	38,400
01600	16	12,5	170	22	40,800	40,800
01700	17	14	175	22	48,000	48,000
01800	18	14	182	22	48,000	48,000
01900	19	16	189	22	49,200	49,200
02000	20	16	195	22	49,200	49,200

*Posebno označene stavke (**bold**) odnose se na robu koju imamo na lageru. Za ostali asortiman rabate i rokove isporuke dajemo na osnovu upita.

*Items given in **bold** figures refer to products on stock. Discount and delivery terms for other product assortment are given at request.

*Die separat gekennzeichneten artikel (**bold**) beziehen sich auf die Ware, die auf Lager liegt. Die Rabatte und Lieferzeiten für das restliche Sortiment geben wir auf Anfrage bekannt.

**MAŠINSKI RAZVRTAČ SA TM, DUGI,
 VALJKASTA DRŠKA**

**CARBIDE TIPPED CHUCKING REAMERS, LONG FLUTES,
 STRAIGHT SHANK**

**HARTMETAL - MASCHINEREIBAHLEN, LANGE NUTEN,
 ZYLINDERSCHAFT**

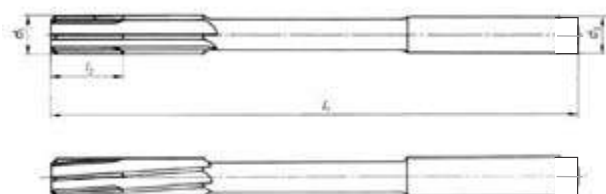

Series					TR05	TR06
	Type				A	B
	d ₁	d ₂	l ₁	l ₂	price EUR	
	mm	mm	mm	mm	each	each
00800	8	8	117	33	25,200	25,200
00900	9	9	125	36	30,800	30,800
01000	10	10	133	38	32,200	32,200
01100	11	10	142	41	35,000	35,000
01200	12	10	151	44	36,400	36,400
01300	13	10	151	44	39,200	39,200
01400	14	12,5	160	47	42,000	42,000
01500	15	12,5	162	50	50,400	50,400
01600	16	12,5	170	52	50,400	50,400
01700	17	14	175	54	57,400	57,400
01800	18	14	182	56	57,400	57,400
01900	19	16	189	58	61,600	61,600
02000	20	16	195	60	61,600	61,600

*Posebno označene stavke (**bold**) odnose se na robu koju imamo na lageru. Za ostali asortiman rabate i rokove isporuke dajemo na osnovu upita.

*Items given in **bold** figures refer to products on stock. Discount and delivery terms for other product assortment are given at request.

*Die separat gekennzeichneten artikel (**bold**) beziehen sich auf die Ware, die auf Lager liegt. Die Rabatte und Lieferzeiten für das restliche Sortiment geben wir auf Anfrage bekannt.

MAŠINSKI RAZVRTAČ SA TM, KRATKI,
 MK DRŠKA

CARBIDE TIPPED CHUCKING REAMERS,
 MORSE TAPER SHANK

HARTMETAL - MASCHINEREIBAHLEN,
 MORSEKEGELSCHAFT



Series					TR11	TR12
	Type				A	B
	d	l ₁	l ₂	MT	price EUR	
	mm	mm	mm		each	each
00800	8	156	16	1	24,960	24,960
00900	9	162	19	1	28,800	28,800
01000	10	168	19	1	31,200	31,200
01100	11	175	19	1	31,200	31,200
01200	12	182	19	1	27,840	27,840
01300	13	182	19	1	30,240	30,240
01400	14	189	19	1	28,800	28,800
01500	15	204	19	2	31,200	31,200
01600	16	210	22	2	31,680	31,680
01700	17	214	22	2	35,040	35,040
01800	18	219	22	2	33,120	33,120
01900	19	223	22	2	41,760	41,760
02000	20	228	22	2	35,280	35,280
02100	21	232	25	2	47,520	47,520
02200	22	237	25	2	43,200	43,200
02400	24	268	25	3	51,864	51,864
02500	25	268	25	3	52,800	52,800
02600	26	273	25	3	55,680	55,680
02800	28	277	30	3	68,640	68,640
03000	30	281	30	3	66,240	66,240
03200	32	317	30	4	71,520	71,520

*Posebno označene stavke (**bold**) odnose se na robu koju imamo na lageru. Za ostali asortiman rabate i rokove isporuke dajemo na osnovu upita.

*Items given in **bold** figures refer to products on stock. Discount and delivery terms for other product assortment are given at request.

*Die separat gekennzeichneten artikel (**bold**) beziehen sich auf die Ware, die auf Lager liegt. Die Rabatte und Lieferzeiten für das restliche Sortiment geben wir auf Anfrage bekannt.

MAŠINSKI RAZVRTAČ SA TM, DUGI, MK DRŠKA

**CARBIDE TIPPED CHUCKING REAMERS,
MORSE TAPER SHANK**

**HARTMETAL - MASCHINEREIBAHLEN,
MORSEKEGELSCHAFT**

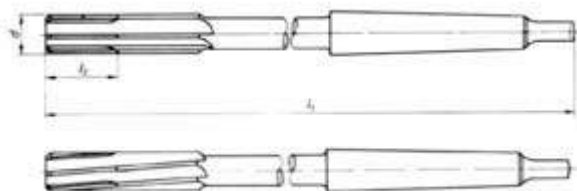

Series	Type				TR15	TR16
	d	l ₁	l ₂	MT	A	B
	mm	mm	mm		price EUR	
					each	each
00800	8	156	33	1	32,200	32,200
00900	9	162	36	1	39,200	39,200
01000	10	168	38	1	39,200	39,200
01100	11	175	41	1	39,200	39,200
01200	12	182	44	1	39,200	39,200
01300	13	182	44	1	39,200	39,200
01400	14	189	47	1	40,600	40,600
01500	15	204	50	2	43,400	43,400
01600	16	210	52	2	46,200	46,200
01700	17	214	54	2	49,000	49,000
01800	18	219	56	2	51,800	51,800
01900	19	223	58	2	54,600	54,600
02000	20	228	60	2	54,600	54,600
02200	22	237	64	2	58,800	58,800
02400	24	268	68	3	74,200	74,200
02500	25	268	68	3	72,800	72,800
02600	26	273	70	3	81,200	81,200
02800	28	277	71	3	93,800	93,800
03000	30	281	73	3	92,400	92,400
03200	32	317	77	3	103,600	103,600
03400	34	321	78	4	119,000	119,000
03500	35	321	78	4	119,000	119,000
03600	36	325	79	4	126,000	126,000
03800	38	329	81	4	134,400	134,400
04000	40	329	81	4	137,200	137,200

*Posebno označene stavke (**bold**) odnose se na robu koju imamo na lageru. Za ostali asortiman rabate i rokove isporuke dajemo na osnovu upita.

*Items given in **bold** figures refer to products on stock. Discount and delivery terms for other product assortment are given at request.

*Die separat gekennzeichneten artikel (**bold**) beziehen sich auf die Ware, die auf Lager liegt. Die Rabatte und Lieferzeiten für das restliche Sortiment geben wir auf Anfrage bekannt.

RAZVRTAČI SA TM, DUGI, NASADNI

SHELL REAMERS WITH CARBIDE TIPS

**AUFSTECK - REIBAHLEN
MIT SCHNEIDPLATTEN AUS HARTMETALL**

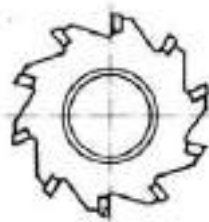
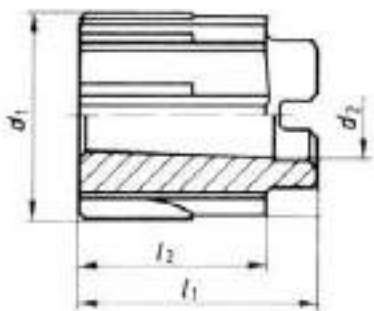

Series					TR21
	d ₁	d ₂	l ₁	l ₂	price EUR
	mm	mm	mm	mm	each
03200	32	13	45	36	78,000
03400	34	13	45	36	78,000
03500	35	13	45	36	78,000
03600	36	16	50	40	81,600
03800	38	16	50	40	82,800
04000	40	16	50	40	78,000
04200	42	16	50	40	84,000
04500	45	16	50	40	84,000
04700	47	19	56	45	103,200
04800	48	19	56	45	103,200
05000	50	19	56	45	103,200
05200	52	19	56	45	156,000
05500	55	22	63	50	162,000
05800	58	22	63	50	168,000
06000	60	22	63	50	168,000
06200	62	22	63	50	174,000
06500	65	27	71	56	186,000
07000	70	27	71	56	192,000
07500	72	27	71	56	198,000
07500	75	27	71	56	198,000

*Posebno označene stavke (**bold**) odnose se na robu koju imamo na lageru. Za ostali asortiman rabate i rokove isporuke dajemo na osnovu upita.

*Items given in **bold** figures refer to products on stock. Discount and delivery terms for other product assortment are given at request.

*Die separat gekennzeichneten artikel (**bold**) beziehen sich auf die Ware, die auf Lager liegt. Die Rabatte und Lieferzeiten für das restliche Sortiment geben wir auf Anfrage bekannt.

**CJEVASTA BURGIJA SA TM PLOČICAMA,
ZA NERĐAJUĆE LIMOVE**

**HOLE SAWS WITH TC TIPPED,
FOR STEINLESS SHEETS**

**LOCHSÄGEN MIT HM BESTÜCKTE FÜR
NICHT ROSTENDEN STAHL FRASSTIFTE**



Series	TG 51			
	Ø	No	Shank	price EUR
	mm	Teeth	Ø mm	each
000140	14,0	3	10	26,400
000145	14,5	3	10	26,400
000150	15,0	3	10	26,400
000152	15,2	3	10	26,400
000160	16,0	3	10	26,400
000165	16,5	3	10	26,800
000170	17,0	3	10	26,800
000180	18,0	4	10	27,600
000186	18,6	4	10	29,200
000190	19,0	4	10	29,200
000200	20,0	4	10	29,200
000204	20,4	4	10	31,600
000210	21,0	4	10	31,600
000220	22,0	5	10	32,400
000225	22,5	5	10	32,800
000230	23,0	5	10	32,800
000240	24,0	5	10	32,800
000250	25,0	5	10	32,800
000255	25,5	5	10	36,800
000260	26,0	5	10	36,800
000270	27,0	6	10	37,200
000280	28,0	6	10	37,600
000290	29,0	6	10	37,600
000300	30,0	6	10	37,600
000310	31,0	6	10	42,000
000320	32,0	6	10	42,000
000330	33,0	7	10	43,200
000340	34,0	7	10	43,200
000350	35,0	7	10	43,200
000360	36,0	7	10	54,000
000370	37,0	7	10	54,000
000380	38,0	7	10	55,200
000390	39,0	8	10	55,200
000400	40,0	8	10	55,200
000410	41,0	8	10	59,600
000420	42,0	8	10	59,600
000430	43,0	9	10	60,400
000440	44,0	9	10	60,400
000450	45,0	9	10	60,400
000460	46,0	9	10	66,800
000470	47,0	9	10	66,800
000480	48,0	10	13	68,000
000490	49,0	10	13	68,000
000500	50,0	10	13	68,000

*Posebno označene stavke (**bold**) odnose se na robu koju imamo na lageru. Za ostali asortiman rabate i rokove isporuke dajemo na osnovu upita.

*Items given in **bold** figures refer to products on stock. Discount and delivery terms for other product assortment are given at request.

*Die separat gekennzeichneten artikel (**bold**) beziehen sich auf die Ware, die auf Lager liegt. Die Rabatte und Lieferzeiten für das restliche Sortiment geben wir auf Anfrage bekannt.

Series	TG 51			
	Ø	No	Shank	price EUR
	mm	Teeth	Ø mm	each
000510	51,0	10	13	72,000
000520	52,0	10	13	72,000
000530	53,0	10	13	72,000
000540	54,0	10	13	72,000
000550	55,0	10	13	72,000
000560	56,0	10	13	85,600
000570	57,0	10	13	85,600
000580	58,0	11	13	88,000
000590	59,0	11	13	88,000
000600	60,0	11	13	88,000
000610	61,0	12	13	97,200
000620	62,0	12	13	97,200
000630	63,0	12	13	97,200
000640	64,0	12	13	97,200
000650	65,0	12	13	97,200
000660	66,0	12	13	104,000
000670	67,0	12	13	104,000
000680	68,0	13	13	104,000
000690	69,0	13	13	104,000
000700	70,0	13	13	104,000
000710	71,0	13	13	117,600
000720	72,0	13	13	117,600
000730	73,0	13	13	117,600
000740	74,0	13	13	117,600
000750	75,0	14	13	117,600
000760	76,0	14	13	130,800
000770	77,0	14	13	130,800
000780	78,0	14	13	130,800
000790	79,0	14	13	130,800
000800	80,0	15	13	130,800
000810	81,0	15	13	136,800
000820	82,0	16	13	136,800
000830	83,0	16	13	136,800
000840	84,0	16	13	136,800
000850	85,0	16	13	136,800
000890	89,0	16	13	161,600
000900	90,0	17	13	161,600
000910	91,0	17	13	165,600
000920	92,0	17	13	165,600
000950	95,0	18	13	165,600
001000	100,0	19	13	199,200
001020	102,0	19	13	224,000
001050	105,0	19	13	224,000
001100	110,0	19	13	246,800
001150	115,0	19	13	264,000
001200	120,0	20	13	288,000
001300	130,0	20	13	312,000
001400	140,0	21	13	328,000
001500	150,0	21	13	360,000

*Posebno označene stavke (**bold**) odnose se na robu koju imamo na lageru. Za ostali asortiman rabate i rokove isporuke dajemo na osnovu upita.

*Items given in **bold** figures refer to products on stock. Discount and delivery terms for other product assortment are given at request.

*Die separat gekennzeichneten artikel (**bold**) beziehen sich auf die Ware, die auf Lager liegt. Die Rabatte und Lieferzeiten für das restliche Sortiment geben wir auf Anfrage bekannt.

**CJEVASTA BURGIJA SA TM PLOČICAMA,
ZA MAŠINE SA ELEKTROMAGNETIM POSTOLJEM**

**ANNULAR CUTTERS WITH CT TIPPED,
FOR MACHINE WITH ELEKTORMAGNETIC STAND**

**KERNBOHRER MIT HM BESTÜCKTE,
FÜR MAGNETSTÄNDERBOHRMACHINEN**



Series			TG 61	TG 62	TG 63	TG 64
	Cutting depth (l, mm)		35	50	35	50
	Adapter		Weldon shank 3/4 (19,05 mm)		Thread M18 x 6 P1,5	
	∅	Number	price EUR			
	mm	of teeth	each	each	each	each
000120	12,0	4			54,464	59,200
000130	13,0	4			54,464	59,200
000140	14,0	4			54,464	59,200
000150	15,0	4			54,464	59,200
000160	16,0	4			54,464	59,200
000170	17,0	4			54,464	59,200
000180	18,0	6	57,408	62,400	57,408	62,400
000190	19,0	6	57,408	62,400	57,408	62,400
000200	20,0	6	57,408	62,400	57,408	62,400
000210	21,0	6	60,720	66,000	60,720	66,000
000220	22,0	6	60,720	66,000	60,720	66,000
000230	23,0	6	60,720	66,000	60,720	66,000
000240	24,0	6	60,720	66,000	60,720	66,000
000250	25,0	6	64,400	70,000	64,400	70,000
000260	26,0	6	64,400	70,000	64,400	70,000
000270	27,0	6	64,400	70,000	64,400	70,000
000280	28,0	6	64,400	70,000	64,400	70,000
000290	29,0	6	64,400	70,000	64,400	70,000
000300	30,0	6	64,400	70,000	64,400	70,000
000310	31,0	6	76,544	83,200	76,544	83,200
000320	32,0	6	76,544	83,200	76,544	83,200
000330	33,0	6	76,544	83,200	76,544	83,200
000340	34,0	6	76,544	83,200	76,544	83,200
000350	35,0	6	76,544	83,200	76,544	83,200
000360	36,0	6		96,000		96,000
000370	37,0	6		96,000		96,000
000380	38,0	8		96,000		96,000
000390	39,0	8		96,000		96,000

*Posebno označene stavke (**bold**) odnose se na robu koju imamo na lageru. Za ostali asortiman rabate i rokove isporuke dajemo na osnovu upita.

*Items given in **bold** figures refer to products on stock. Discount and delivery terms for other product assortment are given at request.

*Die separat gekennzeichneten artikel (**bold**) beziehen sich auf die Ware, die auf Lager liegt. Die Rabatte und Lieferzeiten für das restliche Sortiment geben wir auf Anfrage bekannt.

Series			TG 61	TG 62	TG 63	TG 64
	Cutting depth (l ₁ mm)		35	50	35	50
	Adapter		Weldon shank 3/4 (19,05 mm)		Thread M18 x 6 P1,5	
	∅	Number	price EUR			
mm	of teeth	each	each	each	each	
000400	40,0	8		96,000		96,000
000410	41,0	8		112,000		112,000
000420	42,0	8		112,000		112,000
000430	43,0	8		112,000		112,000
000440	44,0	8		116,800		116,800
000450	45,0	8		116,800		116,800
000460	46,0	8		123,200		123,200
000470	47,0	8		123,200		123,200
000480	48,0	8		123,200		123,200
000490	49,0	8		123,200		123,200
000500	50,0	8		129,200		129,200
000510	51,0	8				129,200
000520	52,0	8				129,200
000530	53,0	8				129,200
000540	54,0	8				129,200
000550	55,0	8				129,200
000560	56,0	8				152,000
000570	57,0	8				152,000
000580	58,0	8				152,000
000590	59,0	8				152,000
000600	60,0	8				152,000
000610	61,0	8				168,000
000620	62,0	8				168,000
000630	63,0	8				168,000
000640	64,0	8				184,000
000650	65,0	8				184,000
000660	66,0	8				184,000
000670	67,0	8				184,000
000680	68,0	8				208,000
000690	69,0	8				208,000
000700	70,0	8				208,000
000710	71,0	8				228,000
000720	72,0	8				228,000
000730	73,0	8				228,000
000740	74,0	8				228,000
000750	75,0	8				228,000
000760	76,0	10				250,000
000770	77,0	10				250,000
000780	78,0	10				250,000
000790	79,0	10				250,000
000800	80,0	10				250,000

*Posebno označene stavke (**bold**) odnose se na robu koju imamo na lageru. Za ostali asortiman rabate i rokove isporuke dajemo na osnovu upita.

*Items given in **bold** figures refer to products on stock. Discount and delivery terms for other product assortment are given at request.

*Die separat gekennzeichneten artikel (**bold**) beziehen sich auf die Ware, die auf Lager liegt. Die Rabatte und Lieferzeiten für das restliche Sortiment geben wir auf Anfrage bekannt.

MINI SKLADIŠTE SA SPIRALNIM BURGIJAMA

MINI STORAGE WITH TWIST DRILLS

SPIRALBOHRER - VORRATSBOX



500 kom/pcs/stück

DIN 338

Ø	kom/pcs/st
1.00	50
1.50	50
2.00	50
2.50	50
3.00	50
3.50	20
4.00	30
4.50	20
5.00	30
5.50	20
6.00	20
6.50	10
7.00	10
7.50	10
8.00	10
8.50	10
9.00	10
9.50	10
10.00	10
10.50	5
11.00	5
11.50	5
12.00	5
12.50	5
13.00	5

Series	BV11	BV13	BV14	BV22	BV26	BV28
Material	HSS	HSS	HSS	HSS	Co 5%	Co 8%
Type	RN	RN	RN	RN	RN	RN
Point angle	118°	118°	118°	130°/C	130°/C	130°/C
Execution	rolled	ground	ground	ground	ground	ground
Finish	black	bright	black	b/g	gold	gold
	price EUR					
SET500	720,000	1.300,000	1.300,000	1.500,000	2.000,000	2.500,000

REKLAMNI KOFER ZA SPIRALNE BURGIJE

TWIST DRILLS STORAGE DISPLAY

SPIRALBOHRER - DISPLAY



150 kom/pcs/stück

DIN 338

Ø	kom/pcs/st
1.00	10
1.50	10
2.00	10
2.50	10
3.00	20
3.50	10
4.00	10
4.50	10
5.00	10
5.50	5
6.00	5
6.50	5
7.00	5
7.50	5
8.00	5
8.50	5
9.00	5
9.50	5
10.00	5

Series	BV11	BV13	BV14	BV22	BV26	BV28
Material	HSS	HSS	HSS	HSS	Co 5%	Co 8%
Type	RN	RN	RN	RN	RN	RN
Point angle	118°	118°	118°	130°/C	130°/C	130°/C
Execution	rolled	ground	ground	ground	ground	ground
Finish	black	bright	black	b/g	gold	gold
	price EUR					
SET150	230,00	360,00	360,00	420,00	560,00	680,00

GARNITURA SPIRALNIH BURGIJA U METALNOJ KASETI

TWIST DRILLS SET IN METAL CASE

SPIRALBOHRERSÄTZ IN METALLKASSETTEN

19 kom/pcs/stück

DIN 338: Ø 1,00-10,00/0,5

25 kom/pcs/stück

DIN 338: Ø 1,00-13,00/0,5



Series	BV11	BV13	BV14	BV22	BV26	BV28
Material	HSS	HSS	HSS	HSS	Co 5%	Co 8%
Type	RN	RN	RN	RN	RN	RN
Point angle	118°	118°	118°	130°/C	130°/C	130°/C
Execution	rolled	ground	ground	ground	ground	ground
Finish	black	bright	black	b/g	gold	gold
	price EUR					
SET019	40,000	70,000	70,000	75,000	85,000	103,000
SET025	72,000	119,000	119,000	138,000	173,000	210,000

50 kom/pcs/stück

DIN 338: Ø 1,00-5,90/0,1



Series	BV11	BV13	BV14	BV22	BV26	BV28
Material	HSS	HSS	HSS	HSS	Co 5%	Co 8%
Type	RN	RN	RN	RN	RN	RN
Point angle	118°	118°	118°	130°/C	130°/C	130°/C
Execution	rolled	ground	ground	ground	ground	ground
Finish	black	bright	black	b/g	gold	gold
	price EUR					
SET050	52,000	81,000	81,000	93,000	123,000	149,000

41 kom/pcs/stück

DIN 338: Ø 6,00-10,00/0,1



Series	BV11	BV13	BV14	BV22	BV26	BV28
Material	HSS	HSS	HSS	HSS	Co 5%	Co 8%
Type	RN	RN	RN	RN	RN	RN
Point angle	118°	118°	118°	130°/C	130°/C	130°/C
Execution	rolled	ground	ground	ground	ground	ground
Finish	black	bright	black	b/g	gold	gold
	price EUR					
SET041	117,000	190,000	190,000	228,000	307,000	375,000

KOMBINOVANA GARNITURA SPIRALNIH BURGIJA

COMBINED TWIST DRILLS SET

KOMBINIERTER SPIRALBOHRERSÄTZ

14 kom/pcs/stück

DIN 338 HSS: Ø 1,00-2,00-3,00-4,00-5,00-6,00-8,00-10,00

DIN 8039: Ø 5,00-6,00-8,00-9,00-10,00-12,00



Series	BVTB
	price EUR
SET 001	20,000

SETOVI BURGIJA ZA KAMEN

CARBIDE TIPPED MASONRY DRILLS SETS

HARTMETALLSTEINBOHRERSATZ



5 kom/pcs/stück

DIN 8039: Ø 4,00-5,00-6,00-7,00-8,00

DIN 8039: Ø 7,00-8,00-9,00-10,00-12,0

Series	TB10
	price EUR
SETM	8,500
SETV	11,500

GARNITURA GLATKIH BURGIJA ZA LIM

DRILL BITS SET FOR METAL SHEETS AND TUBES

BLECHSCHÄBOHRER - SORTIMENT



3 kom/pcs/stück

Ø 3-14, 6-20, 16-30

Series	SU51		SU52
	Material	HSS	Co 5%
	price EUR		
SET003		93,000	113,000

GARNITURA KUPASTIH UPUŠTAČA SA 3 ŽLIJEBA - 90°

SET OF DEBURRING TOOLS WITH 3 FLUTERS - 90°

KEGELSENKER SORTIMENT - 90°



6 kom/pcs/stück

DIN 335: Ø 6,3; 8,3; 10,4; 12,4; 16,5; 20,5

Series	SU25		SU26
	Material	HSS	Co 5%
	price EUR		
SET006		108,000	143,000

GARNITURE NAVOJNOG ALATA

THREADING TOOLS SETS

GEWINDESCHNEIDWERKZEUGSÄTZ



45 kom/pcs/stück

Series	METAL BOX	PLASTIC BOX
	USET 01	USET 02
price EUR		
	400,000	300,000

Metalna kutija/Metal box/Metallkassetten

SADRŽAJ/CONTENTS/INHALT:

	DIN 352 SET	M3 M4 M5 M6 M8 M10
	DIN 223	M12
	DIN 338	2,50 3,30 4,20 5,00 6,80 8,50 10,20
	DIN 1814	N°1 & N°2
	DIN 225	20x5 20x7 25x9 30x11 38x14
	TAP HOLDER	
	SCREW DRIVER	
	SCREW PITCH GAGES	

Plastična kutija/Plastic box/Polykassetten

GARNITURA NAVOJNOG ALATA U METALNOJ KASETI

THREADING TOOLS SET IN METAL CASE

GEWINDESCHNEIDWERKZEUGSÄTZ IN METALLKASSETTEN



55 kom/pcs/stück

Series	METAL BOX
	price EUR
USET 03	800,000

SADRŽAJ/CONTENTS/INHALT:

	DIN 352 SET	M3 M4 M5 M6 M8 M10
	DIN 223	M12 M14 M16 M18 M20
	DIN 1814	N°1 & N°3
	DIN 225	20x5 20x7 25x9 30x11 38x14 45x18
	TAP HOLDER	
	SCREW DRIVER	
	SCREW PITCH GAGES	

GARNITURE NAVOJNOG ALATA U METALNOJ KASETI "HOBBY"







THREADING TOOLS SETS IN METAL CASE "HOBBY"

GEWINDESCHNEIDWERKZEUGSÄTZ IN METALLKASSETTE "HOBBY"

33 kom/pcs/stück

Series	METAL BOX
	price EUR
USET 04	280,000



SADRŽAJ/CONTENTS/INHALT:		
	DIN 352 SET	M3 M4 M5 M6 M8 M10
	DIN 223 (25x9)	M12
	DIN 1814	N°1
	DIN 225	25x9
	TAP HOLDER	
	SCREW DRIVER	
	SCREW PITCH GAGES	